

APPLICATIONS

- Rectification
- Freewheel Diode
- DC Motor Control
- Power Supplies
- Welding
- Battery Chargers

FEATURES

- Double Side Cooling
- High Surge Capability

VOLTAGE RATINGS

Type Number	Repetitive Peak Reverse Voltage V_{RRM} V	Conditions
TR1107SG40	4000	$V_{RSM} = V_{RRM} + 100V$
TR1107SG39	3900	
TR1107SG38	3800	
TR1107SG37	3700	
TR1107SG36	3600	
TR1107SG35	3500	

Lower voltage grades available.

KEY PARAMETERS

V_{RRM}	4000V
$I_{F(AV)}$	870A
I_{FSM}	15000A

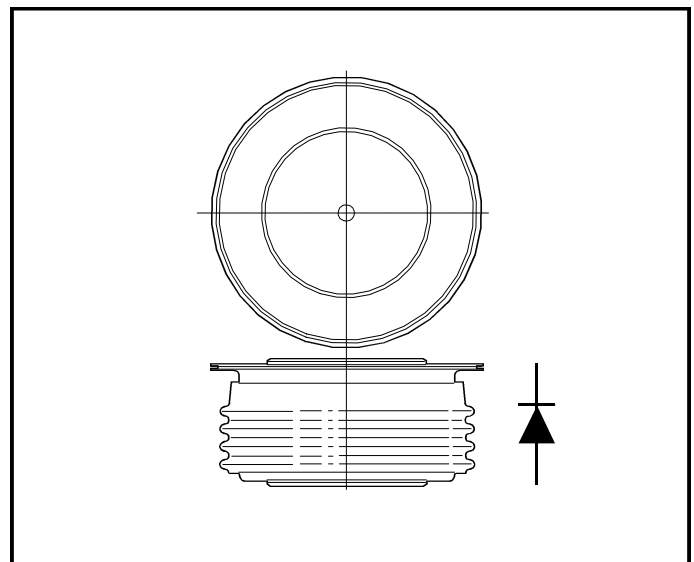

Outline type code: G.
See Package Details for further information.

CURRENT RATINGS

Symbol	Parameter	Conditions	Max.	Units
Double Side Cooled				
$I_{F(AV)}$	Mean forward current	Half wave resistive load, $T_{case} = 100^{\circ}C$	870	A
$I_{F(RMS)}$	RMS value	$T_{case} = 100^{\circ}C$	1366	A
I_F	Continuous (direct) forward current	$T_{case} = 100^{\circ}C$	1280	A
Single Side Cooled (Anode side)				
$I_{F(AV)}$	Mean forward current	Half wave resistive load, $T_{case} = 100^{\circ}C$	550	A
$I_{F(RMS)}$	RMS value	$T_{case} = 100^{\circ}C$	863	A
I_F	Continuous (direct) forward current	$T_{case} = 100^{\circ}C$	740	A

SURGE RATINGS

Symbol	Parameter	Conditions	Max.	Units
I_{FSM}	Surge (non-repetitive) forward current	10ms half sine; $T_{case} = 150^{\circ}C$ $V_R = 50\% V_{RRM} - 1/4$ sine	12.0	kA
I^2t	I^2t for fusing		0.72×10^6	A ² s
I_{FSM}	Surge (non-repetitive) forward current	10ms half sine; $T_{case} = 150^{\circ}C$ $V_R = 0$	15.0	kA
I^2t	I^2t for fusing		1.125×10^6	A ² s

THERMAL AND MECHANICAL DATA

Symbol	Parameter	Conditions		Min.	Max.	Units	
$R_{th(j-c)}$	Thermal resistance - junction to case	Double side cooled	dc	-	0.032	$^{\circ}C/W$	
		Single side cooled	Anode dc	-	0.064	$^{\circ}C/W$	
			Cathode dc	-	0.064	$^{\circ}C/W$	
$R_{th(c-h)}$	Thermal resistance - case to heatsink	Clamping force 12.0kN with mounting compound		Double side	-	0.008	$^{\circ}C/W$
				Single side	-	0.016	$^{\circ}C/W$
T_{vj}	Virtual junction temperature	Forward (conducting)		-	160	$^{\circ}C$	
		Reverse (blocking)		-	150	$^{\circ}C$	
T_{stg}	Storage temperature range			-55	175	$^{\circ}C$	
-	Clamping force			11.5	13.5	kN	

CHARACTERISTICS

Symbol	Parameter	Conditions	Min.	Max.	Units
V_{FM}	Forward voltage	At 1800A peak, $T_{case} = 25^{\circ}C$	-	1.6	V
I_{RRM}	Peak reverse current	At V_{RRM} , $T_{case} = 150^{\circ}C$	-	50	mA
Q_S	Total stored charge	$I_F = 1000A, di_{RR}/dt = 3A/\mu s$ $T_{case} = 150C, V_R = 100V$	-	2000	μC
I_{RR}	Peak recovery current		-	80	A
V_{TO}	Threshold voltage	At $T_{vj} = 150C$	-	0.75	V
r_T	Slope resistance	At $T_{vj} = 150C$	-	0.44	m Ω

CURVES

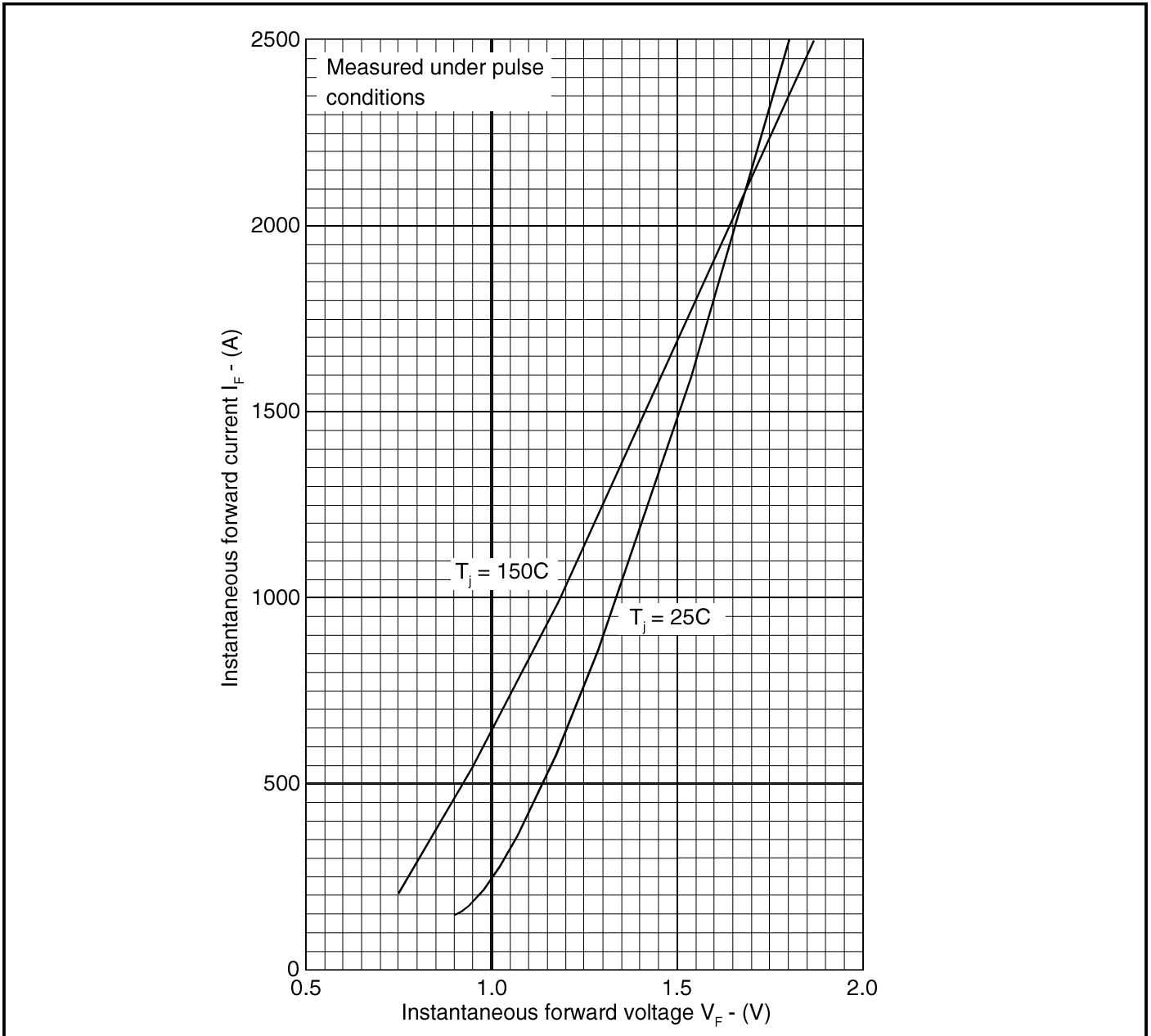

Fig. 1 Maximum (limit) forward characteristics

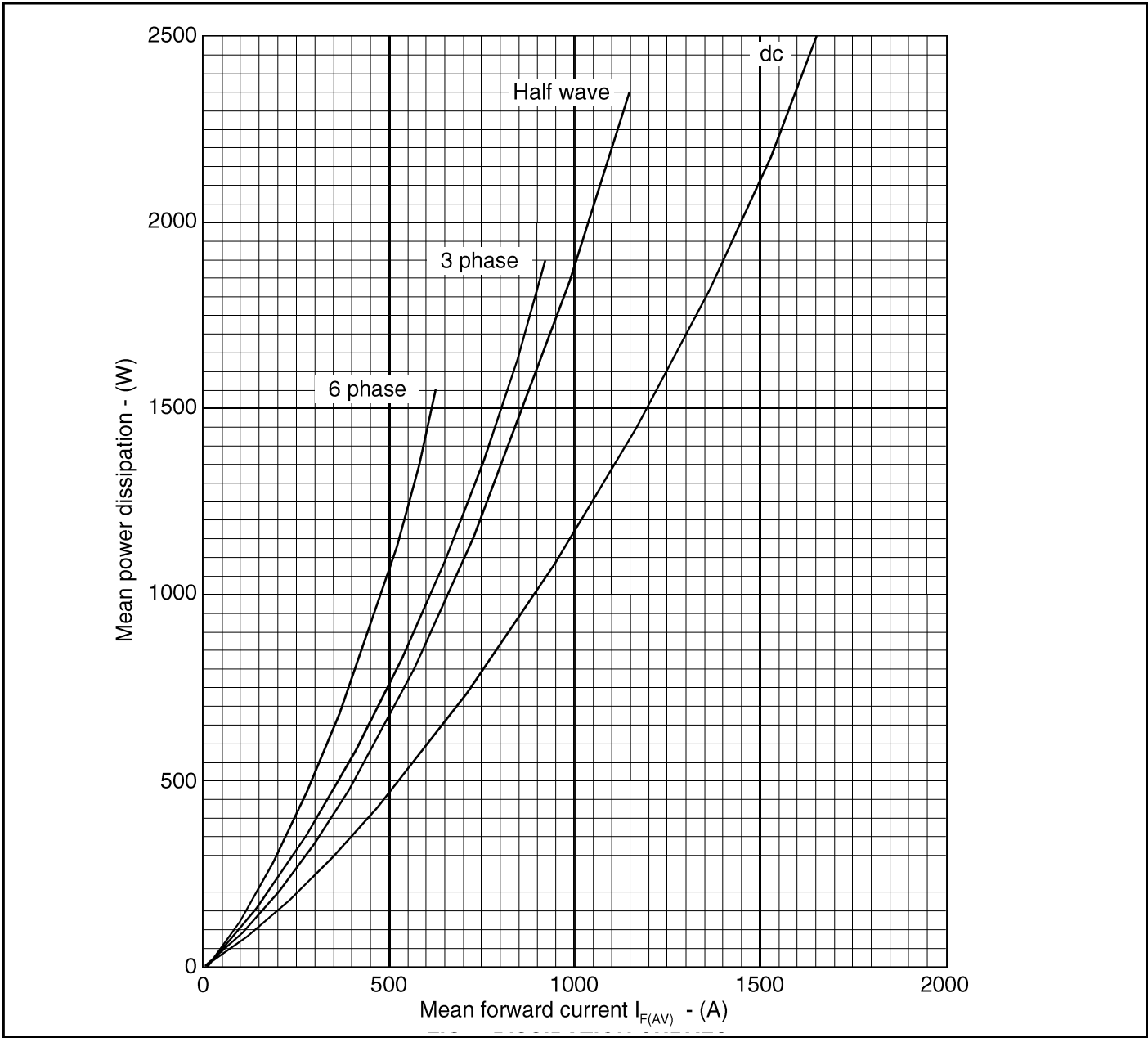

Fig. 2 Dissipation curves

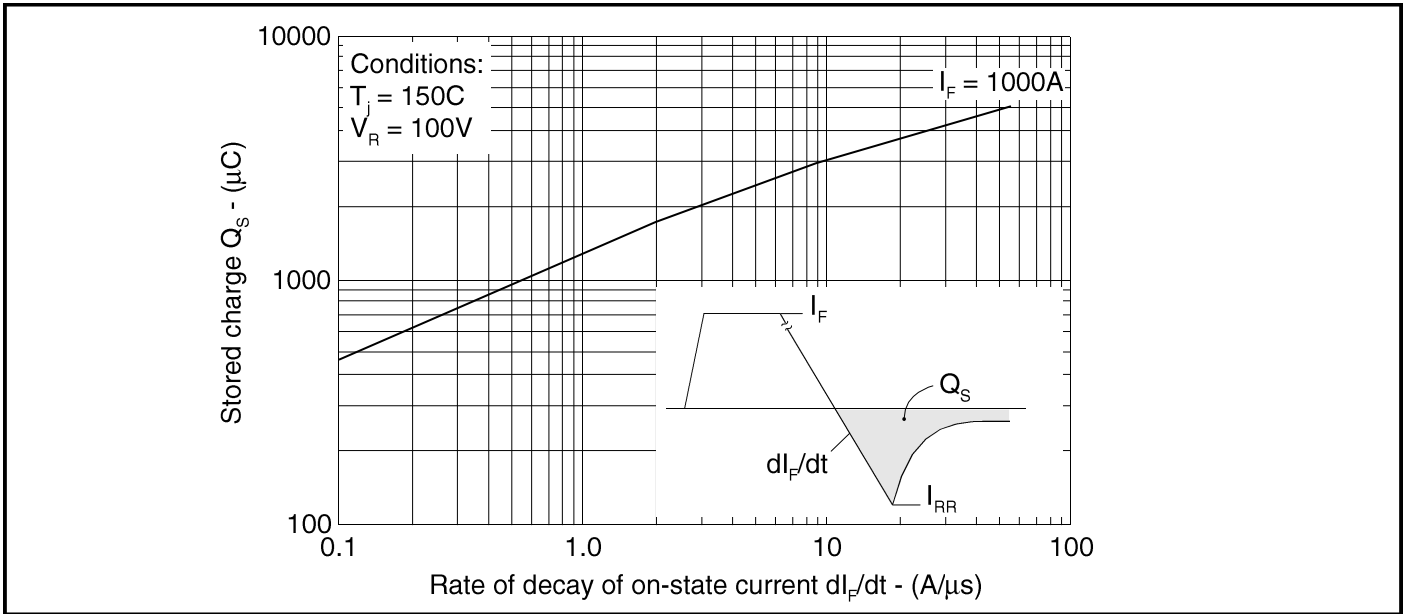

Fig. 3 Maximum total stored charge

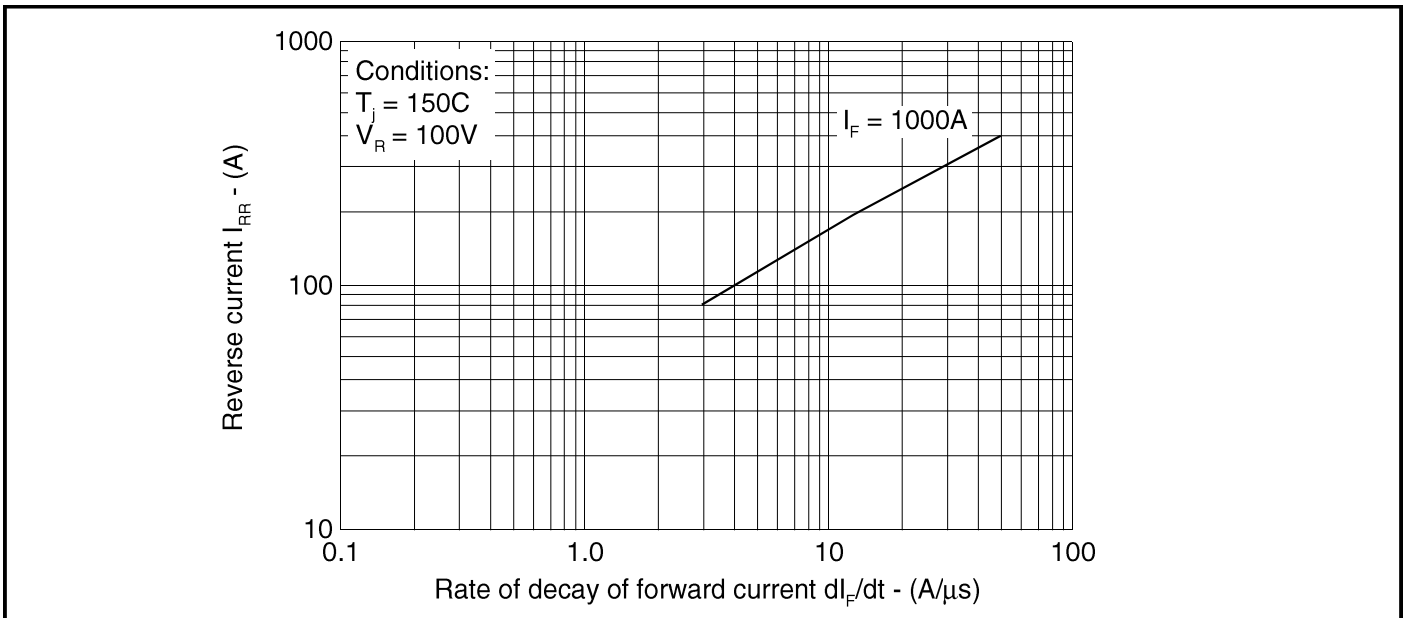

Fig. 4 Maximum reverse recovery current

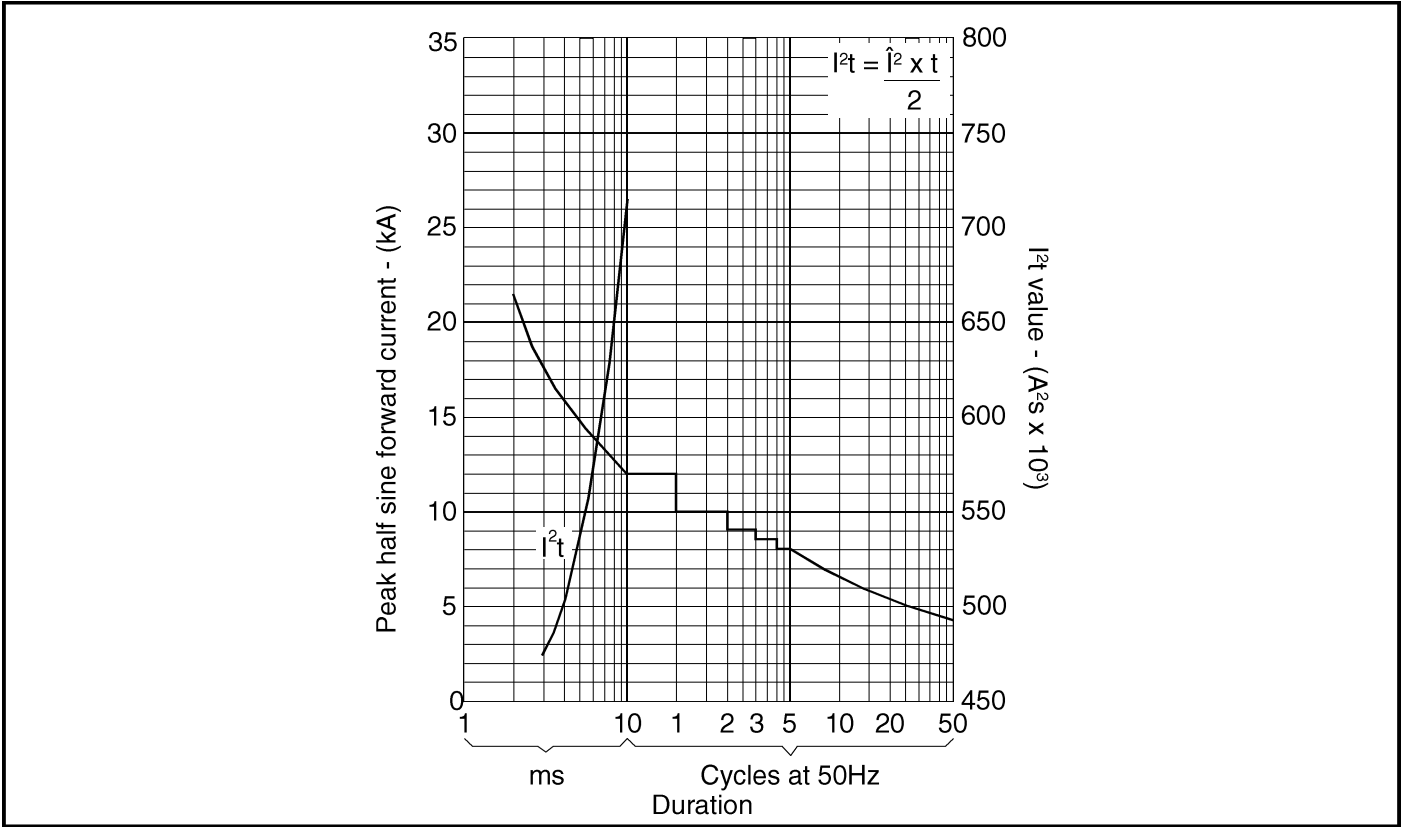

Fig. 5 Surge (non-repetitive) forward current vs time (with 50% V_{RRM} , $T_{case} = 150C$)

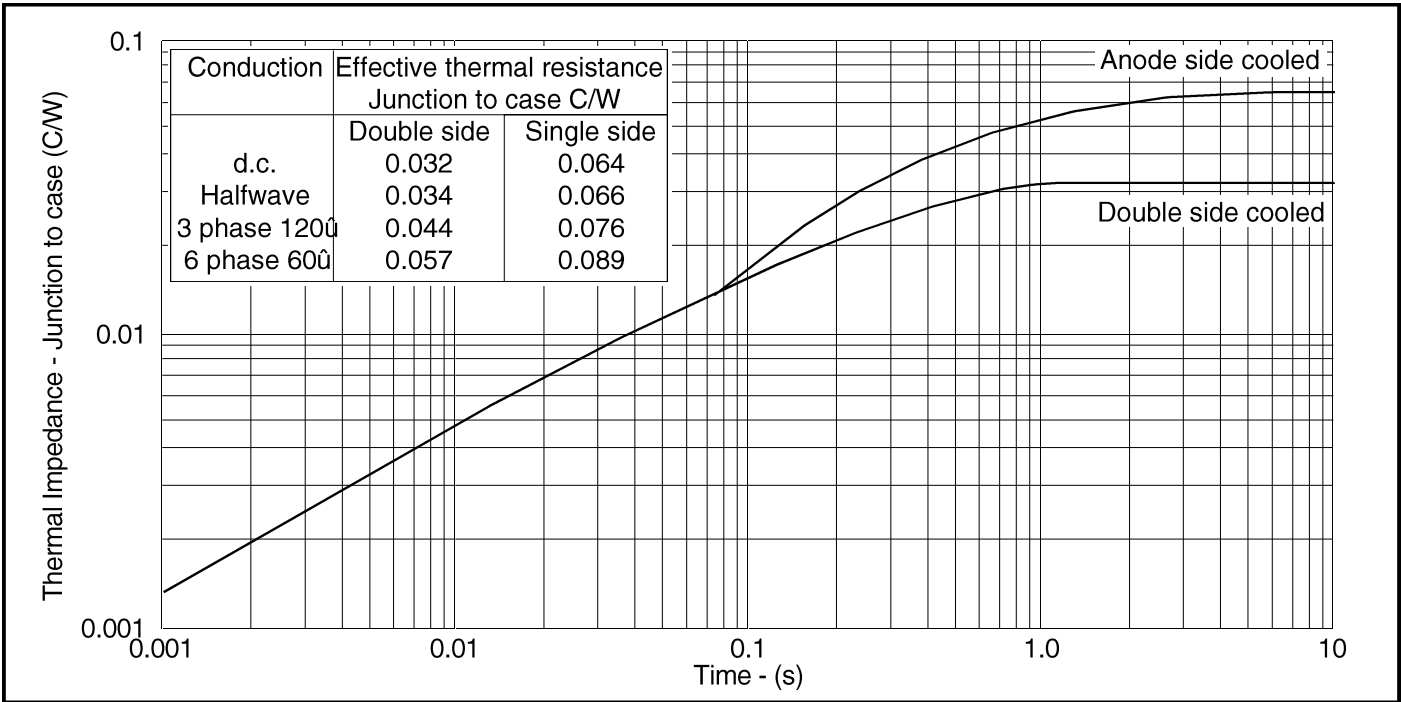

Fig. 6 Transient thermal impedance - junction to case - (C/W)

PACKAGE DETAILS

For further package information, please contact your local Customer Service Centre. All dimensions in mm, unless stated otherwise. DO NOT SCALE.

