

THOMSON SEMICONDUCTORS

2N 1843A → 2N 1850A
 TR 1010 → TR 9010
 THYRISTORS
 T-25-15

78C 07700 D

General purpose SCR suited for power supplies up to 400 Hz on resistive or inductive loads.

- VRRM up to 1 200 V.
- Glass passivated chips.
- High stability and reliability.

Thyristors à usage général, pour des alimentations jusqu'à 400 Hz sur charges résistives ou inductives.

- VRRM jusqu'à 1 200 V.
- Pastilles glassivées.
- Grande stabilité des caractéristiques.

$I_T(RMS) = 16 \text{ A} / T_{case} = 80^\circ\text{C}$

$50 \text{ V} \leq \frac{V_{DRM}}{V_{RRM}} \leq 1200 \text{ V}$

Case : TO 48 metal (CB-267)
 Boîtier :

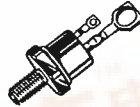

ABSOLUTE RATINGS (LIMITING VALUES) VALEURS LIMITES ABSOLUES D'UTILISATION	Symbol	Value	Unit
RMS on-state current* Courant efficace à l'état passant*	$I_T(RMS)$	16 @ $T_{case} = 80^\circ\text{C}$	A
Mean on-state current* Courant moyen à l'état passant*	$I_T(AV)$	10 @ $T_{case} = 80^\circ\text{C}$	A
Non repetitive surge peak on-state current** Courant non répétilif de surcharge crête accidentelle à l'état passant**	I_{TSM} I_{TSM}	157 (t = 8,3 ms) 150 (t = 10 ms) @ $T_J \leq 125^\circ\text{C}$	A A
$I^2 t$ for fusing Valeur de la constante $I^2 t$	$I^2 t$	112,5 (t = 10 ms) @ $T_J \leq 125^\circ\text{C}$	A ² s
Critical rate of rise of on-state current*** Vitesse critique de croissance du courant à l'état passant***	di/dt	100	A/ μs
Storage and operating junction temperatures Températures extrêmes de stockage et de jonction en fonctionnement	T_{stg} T_J	-40, + 150 -40, + 125	$^\circ\text{C}$ $^\circ\text{C}$

@ $T_J = 125^\circ\text{C}$	2N 1843 A	2N 1844 A	2N 1846 A	2N 1848 A	2N 1849 A	2N 1850 A	TR 6010	TR 7010	TR 8010	TR 9010	TR 1010	TR 1110	TR 1210
VDRM = VRRM (V)	50	100	200	300	400	500	600	700	800	900	1000	1100	1200

Thermal resistances Résistances thermiques	Symbol	Value	Unit
— Junction to case for D.C. Jonction-boîtier en continu	$R_{th(j-c)}$	2	$^\circ\text{C}/\text{W}$
— Contact (case to heatsink) Contact (boîtier-radiateur)	$R_{th(c-h)}$	0,4	$^\circ\text{C}/\text{W}$

* Single phase circuit, 180° conduction angle
 * Circuit monophasé, angle de conduction 180°

** Half sine wave
 ** Demi-onde sinusoïdale

*** Gate supply 20 V/20 Ω - tr $\leq 0,1 \mu\text{s}$ - Half sine wave of 6,3 μs
 *** Générateur de gâchette Demi-sinusoïde

May 1984 - 1/5

THOMSON SEMICONDUCTORS
 45, avenue de l'Europe - 78140 VÉLIZY - France
 Tél. : 94.97.19 / Téléx : 698 866 F



78C 07701 D
T-25-15

GATE CHARACTERISTICS (Maximum values)
CARACTÉRISTIQUES DE GACHETTE (Valeurs maximales)

$P_{GM} = 5 \text{ W}$ ($t = 100 \mu\text{s}$)
 $P_{G(AV)} = 1 \text{ W}$

$I_{FGM} = 2 \text{ A}$ ($t = 100 \mu\text{s}$)
 $V_{FGM} = 10 \text{ V}$ ($t = 100 \mu\text{s}$)

$V_{RGM} = 5 \text{ V}$

ELECTRICAL CHARACTERISTICS
CARACTÉRISTIQUES ÉLECTRIQUES

Symbol	Value			Unit	Test conditions			
	min	typ	max					
I_{GT}			80	mA	$T_J = 25^\circ\text{C}$	$V_D = 12 \text{ V}$	$R_L = 33 \Omega$	$t_p \geq 20 \mu\text{s}$
V_{GT}			3	V	$T_J = 25^\circ\text{C}$	$V_D = 12 \text{ V}$	$R_L = 33 \Omega$	$t_p \geq 20 \mu\text{s}$
V_{GD}	0,25			V	$T_J = 125^\circ\text{C}$	$V_D = V_{DRM}$	$R_L = 3,3 \text{ k}\Omega$	
I_H		20		mA	$T_J = 25^\circ\text{C}$	$I_T = 0,5 \text{ A}$	Gate open	
V_{TM}			2,2	V	$T_J = 25^\circ\text{C}$	$I_{TM} = 30 \text{ A}$		$t_p = 10 \text{ ms}$
I_{DRM}			5	mA	$T_J = 125^\circ\text{C}$	V_{DRM} specified		
I_{RRM}			5	mA	$T_J = 125^\circ\text{C}$	V_{RRM} specified		
t_{gt}		2		μs	$T_J = 25^\circ\text{C}$ $I_G = 200 \text{ mA}$	$I_T = 30 \text{ A}$ $di_G/dt = 2 \text{ A}/\mu\text{s}$	$V_D = V_{DRM}$	
t_q		100		μs	$T_J = 125^\circ\text{C}$ $di_R/dt = 30 \text{ A}/\mu\text{s}$	$I_T = 10 \text{ A}$ $dv/dt = 20 \text{ V}/\mu\text{s}$	$V_R = 30 \text{ V}$	$V_D = 0,67 V_{DRM}$ Gate open
dv/dt^*	100			$\text{V}/\mu\text{s}$	$T_J = 125^\circ\text{C}$	Linear slope up to $0,67 V_{DRM}$ specified		

* For higher guaranteed values, please consult us.

CASE DESCRIPTION
DESCRIPTION DU BOITIER

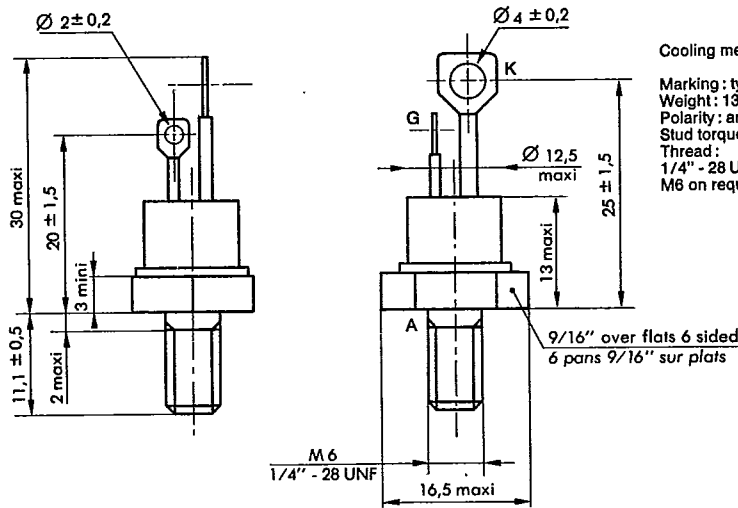

Cooling method : by conduction (method C)
Marking : type number
Weight : $13,5 \pm 1 \text{ g}$
Polarity : anode to case
Stud torque : $3,5 \text{ m} \wedge \text{Nmin} - 3,8 \text{ m} \wedge \text{Nmax}$
Thread : $1/4'' - 28 \text{ UNF}$: type N°
M6 on request : type N° + suffix M

TO 48 metal (CB-267)

2N 1843A → 2N 1850A — TR 1010 → TR 9010
K

78C 07702 D
T-25-15

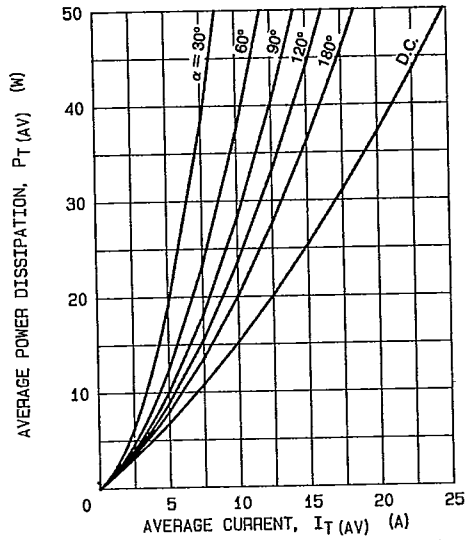
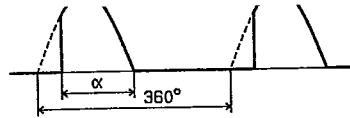

FIG.1 - MAXIMUM ON-STATE POWER DISSIPATION FOR SINUSOIDAL CURRENT WAVEFORM

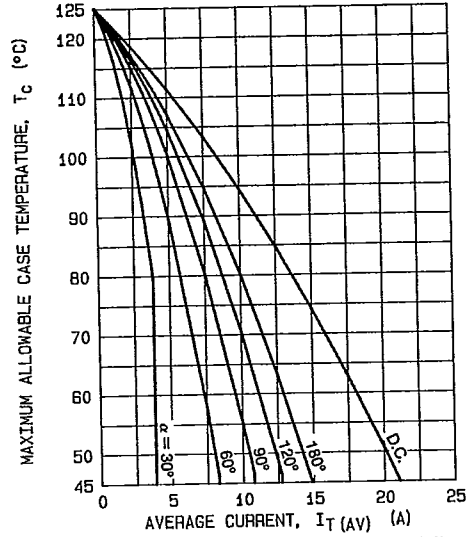

FIG.2 - MAXIMUM ALLOWABLE CASE TEMPERATURE FOR SINUSOIDAL CURRENT WAVEFORM

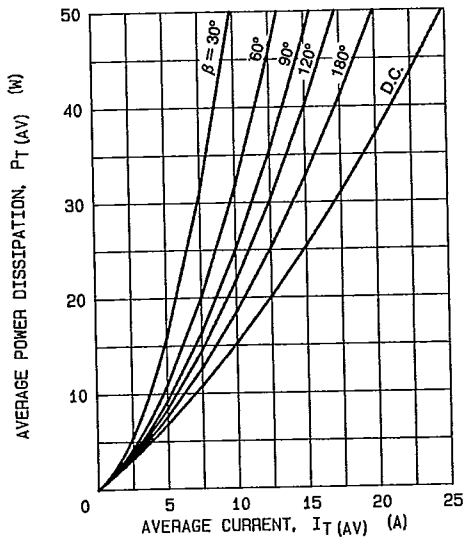
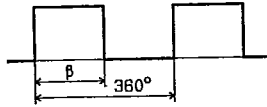

FIG.3 - MAXIMUM ON-STATE POWER DISSIPATION FOR RECTANGULAR CURRENT WAVEFORM

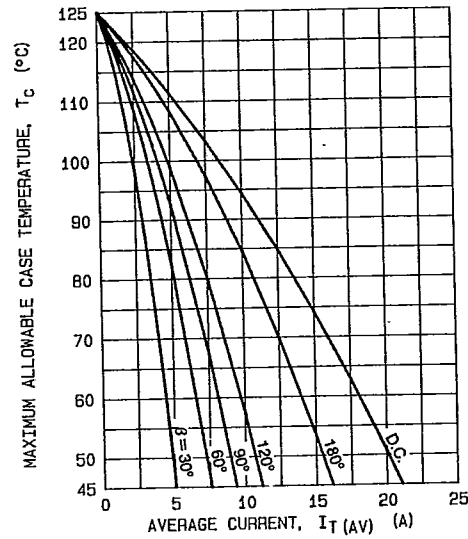

FIG.4 - MAXIMUM ALLOWABLE CASE TEMPERATURE FOR RECTANGULAR CURRENT WAVEFORM

THOMSON SEMICONDUCTORS

2N 1843A → 2N 1850A — TR 1010 → TR 9010

K

78C 07703 D

T-25-15

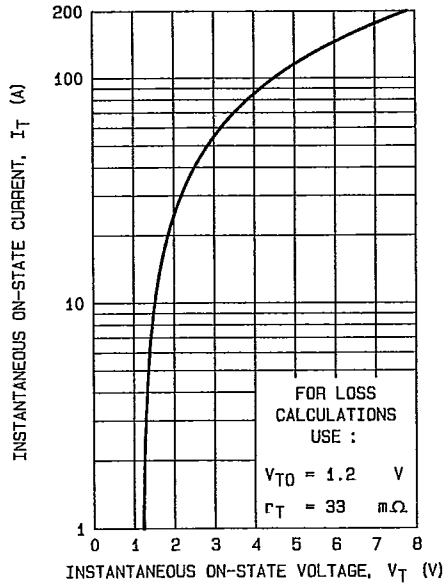

FIG.5 - MAXIMUM ON-STATE CONDUCTION CHARACTERISTIC ($T_J = 125^\circ\text{C}$).

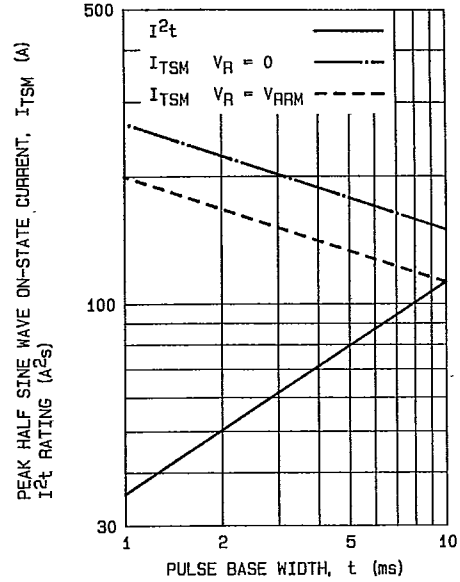

FIG.6 - NON REPETITIVE SUB-CYCLE SURGE ON-STATE CURRENT AND I^2t RATING (INITIAL $T_J = 125^\circ\text{C}$).

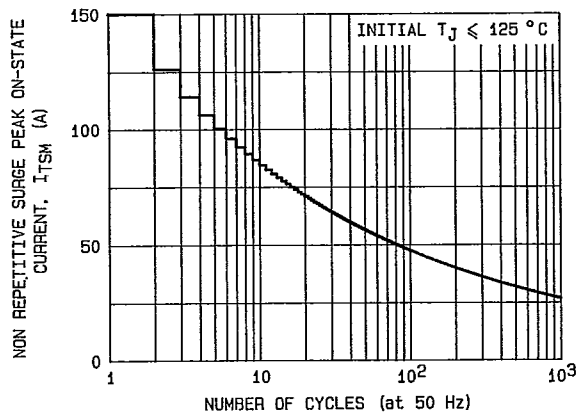

FIG.7 - NON REPETITIVE SURGE PEAK ON-STATE CURRENT VERSUS NUMBER OF CYCLES.

2N 1843A → 2N 1850A — TR 1010 → TR 9010

:K

78C 07704 D

T-25-15

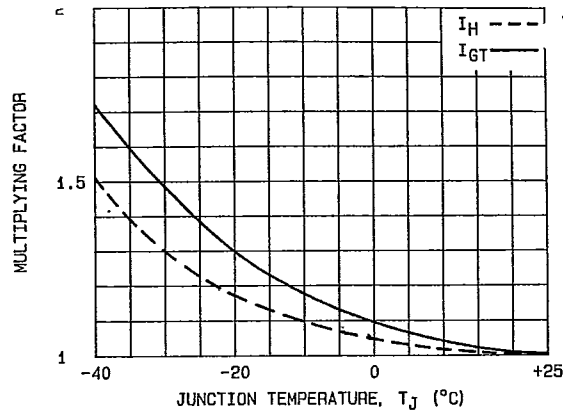

FIG.8 - RELATIVE VARIATION OF GATE TRIGGER CURRENT AND HOLDING CURRENT VERSUS JUNCTION TEMPERATURE.

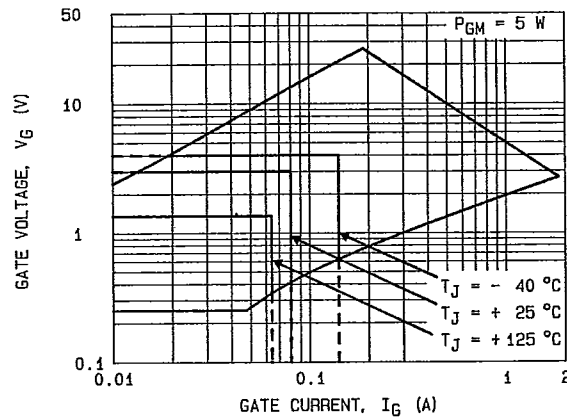
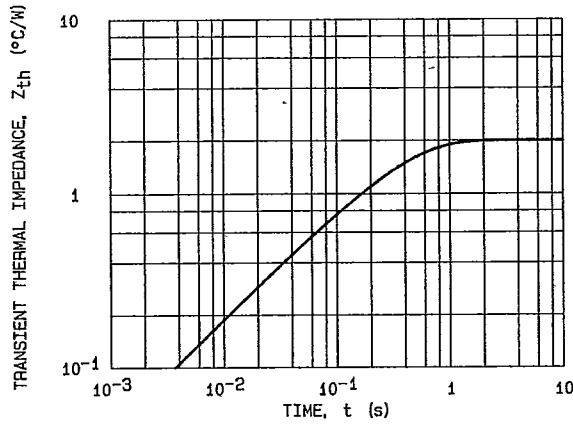

FIG.9 - GATE TRIGGER CHARACTERISTICS.



Conduction angle (α, β)	Effective thermal resistance ($^{\circ}\text{C/W}$) junction to case	
	Sinusoidal	Rectangular
180°	2.23	2.18
120°	2.31	3.09
90°	2.47	3.50
60°	2.88	3.91
30°	3.71	4.94

FIG.10 - TRANSIENT THERMAL IMPEDANCE JUNCTION TO CASE.