

# FILTERING

## SPLIT FERRITES FOR ROUND CABLE

### Features

- Split construction permits easy insertion of cables already wired and installed, or cables with connectors.
- Comes with nylon mounting clamp.
- Clamps are made of UL recognized 6/6 nylon (UL94V-2)

### Application

For noise problems arising from office automation equipment or other digital equipment.

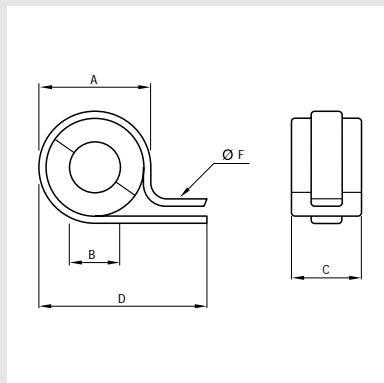

Part No.	Unit: mm					Impedance ( $\Omega$ ) 1 turn		Impedance ( $\Omega$ ) 2 turn		Max. Cable Diameter
	A	B	C	D	F	25MHz	100MHz	25MHz	100MHz	
TRCN-16-8-13	19.4	8.2	13.0	30.2	4.3	59	93	231	396	$\phi$ 8.0 or less
TRCN-16-8-16	19.4	8.2	16.0	30.2	4.3	64	106	291	504	$\phi$ 8.0 or less
TRCN-20-10-10	25.7	10.4	10.0	38.2	5.1	53	84	203	360	$\phi$ 10.0 or less
TRCN-23-11-14	26.8	11.4	14.0	39.4	5.1	72	112	289	449	$\phi$ 11.0 or less
TRCN-28-16-13	32.8	16.4	13.0	45.0	5.1	56	90	226	374	$\phi$ 16.0 or less
TRCN-28-16-20	32.8	16.4	20.0	45.0	5.1	79	135	325	579	$\phi$ 16.0 or less
TRCN-40-27-15	44.6	27.4	15.0	57.3	5.1	48	84	195	365	$\phi$ 27.0 or less

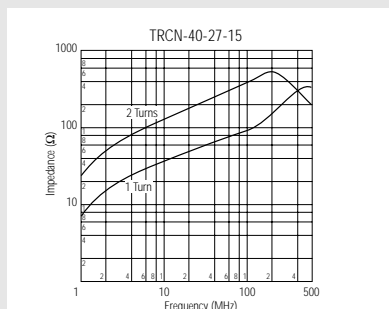
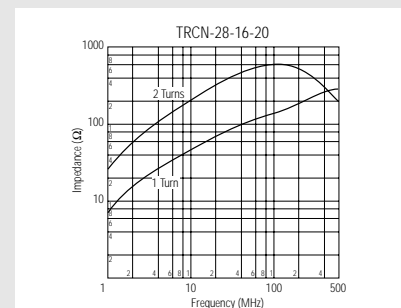
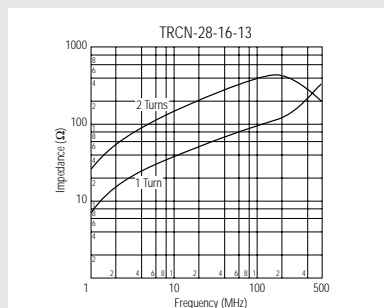
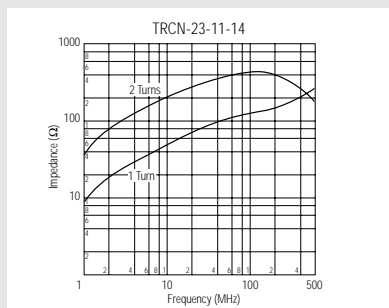
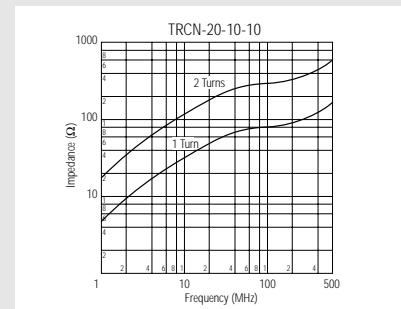
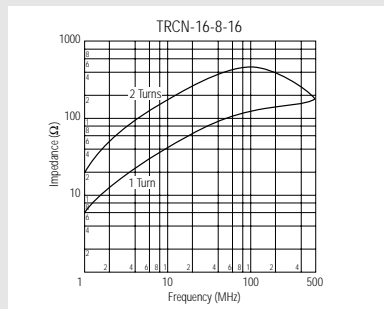
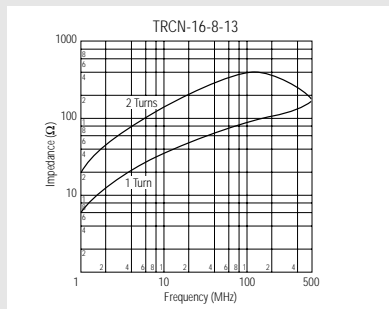

KE KITAGAWA

Elbinger Straße 3-5 · D-63110 Rodgau-Jügesheim · Germany · Telefon 0 61 06/85 24 - 0 · Telefax 0 61 06/85 24-30 (31)