

# INTEGRATED IQ DEMODULATOR

Check for Samples: [TRF371125](#)

## FEATURES

- Frequency Range: 700 MHz to 4000 MHz
- Integrated Baseband Programmable-Gain Amplifier
- On-Chip Programmable Baseband Filter
- High Out-of-Band IP3: 24 dBm at 2400 MHz
- High Out-of-Band IP2: 60 dBm at 2400 MHz
- Hardware and Software Power Down
- Three-Wire Serial Interface
- Single Supply: 4.5-V to 5.5-V Operation
- Silicon Germanium Technology

## APPLICATIONS

- Multicarrier Wireless Infrastructure
- WiMAX
- High-Linearity Direct-Downconversion Receiver
- LTE (Long Term Evolution)

## DESCRIPTION

The TRF371125 is a highly linear and integrated direct-conversion quadrature demodulator. The TRF371125 integrates balanced I and Q mixers, LO buffers, and phase splitters to convert an RF signal directly to I and Q baseband. The on-chip programmable-gain amplifiers allow adjustment of the output signal level without the need for external variable-gain (attenuator) devices. The TRF371125 integrates programmable baseband low-pass filters that attenuate nearby interference, eliminating the need for an external baseband filter.

Housed in a 7-mm × 7-mm QFN package, the TRF371125 provides the smallest and most integrated receiver solution available for high-performance equipment.

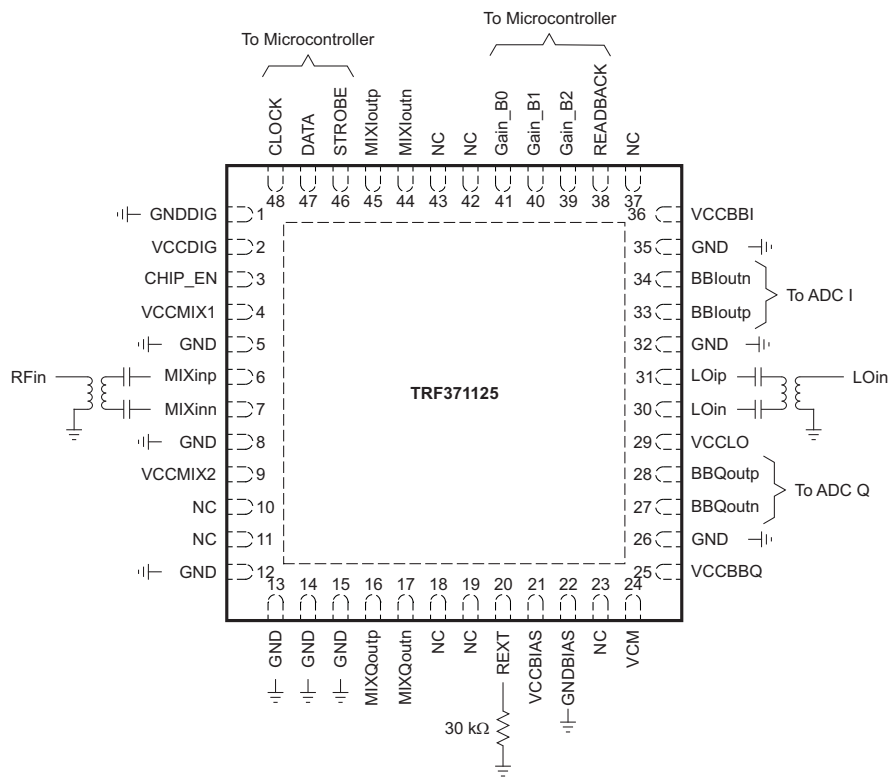

Please be aware that an important notice concerning availability, standard warranty, and use in critical applications of Texas Instruments semiconductor products and disclaimers thereto appears at the end of this data sheet.

All trademarks are the property of their respective owners.



These devices have limited built-in ESD protection. The leads should be shorted together or the device placed in conductive foam during storage or handling to prevent electrostatic damage to the MOS gates.

**AVAILABLE DEVICE OPTIONS<sup>(1)</sup>**

PRODUCT	PACKAGE LEAD	PACKAGE DESIGNATOR(1)	SPECIFIED TEMPERATURE RANGE	PACKAGE MARKING	ORDERING NUMBER	TRANSPORT MEDIA, QUANTITY
TRF371125	QFN-48	RGZ	-40°C to 85°C	TRF371125	TRF371125IRGZR	Tape and Reel, 2500
					TRF371125IRGZT	Tape and Reel, 500

**FUNCTIONAL DIAGRAM**

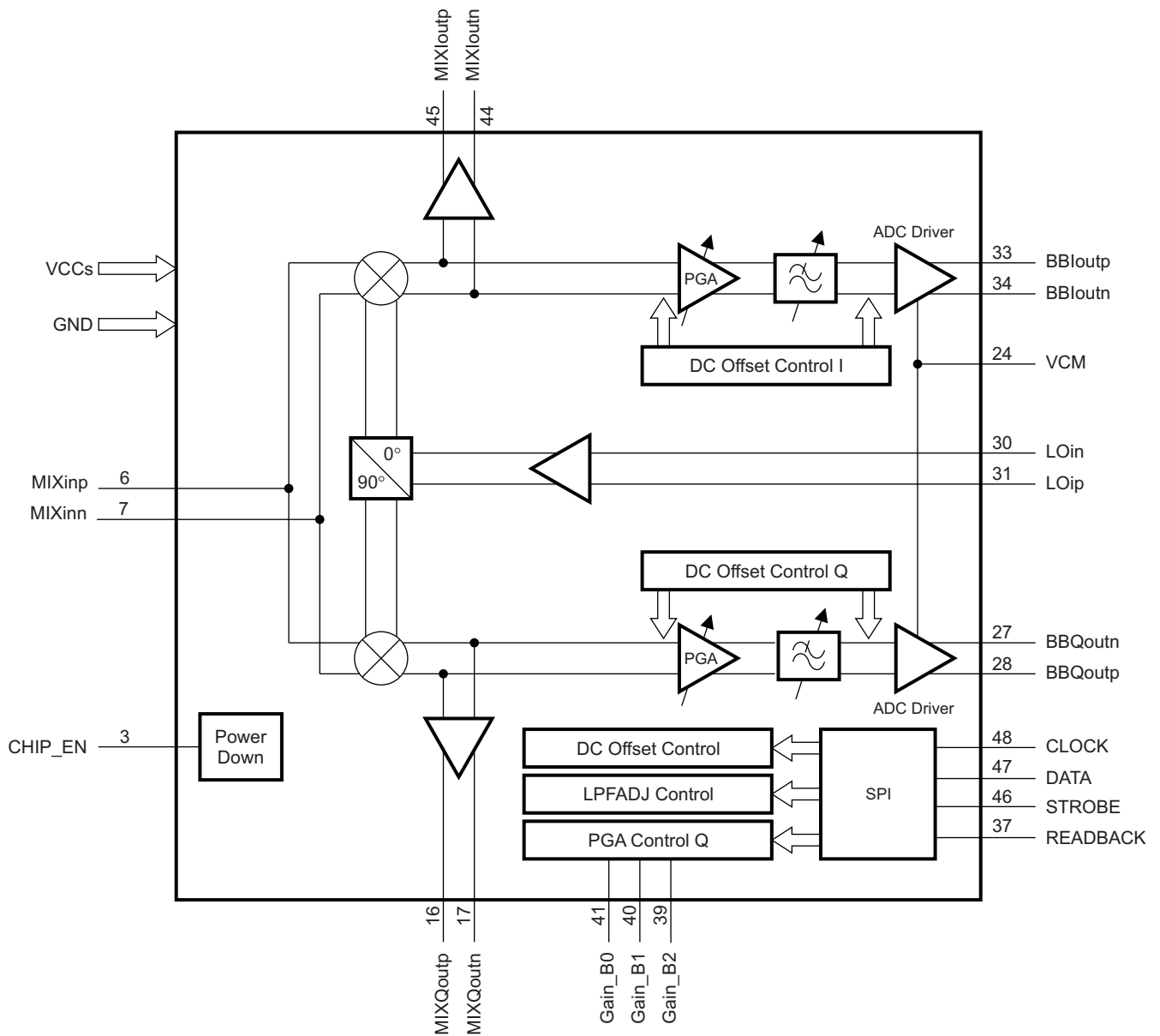

B0385-01

(1) For the most current package and ordering information, see the Package Option Addendum at the end of this document, or see the TI web site at [www.ti.com](http://www.ti.com).

DEVICE INFORMATION

PIN ASSIGNMENTS

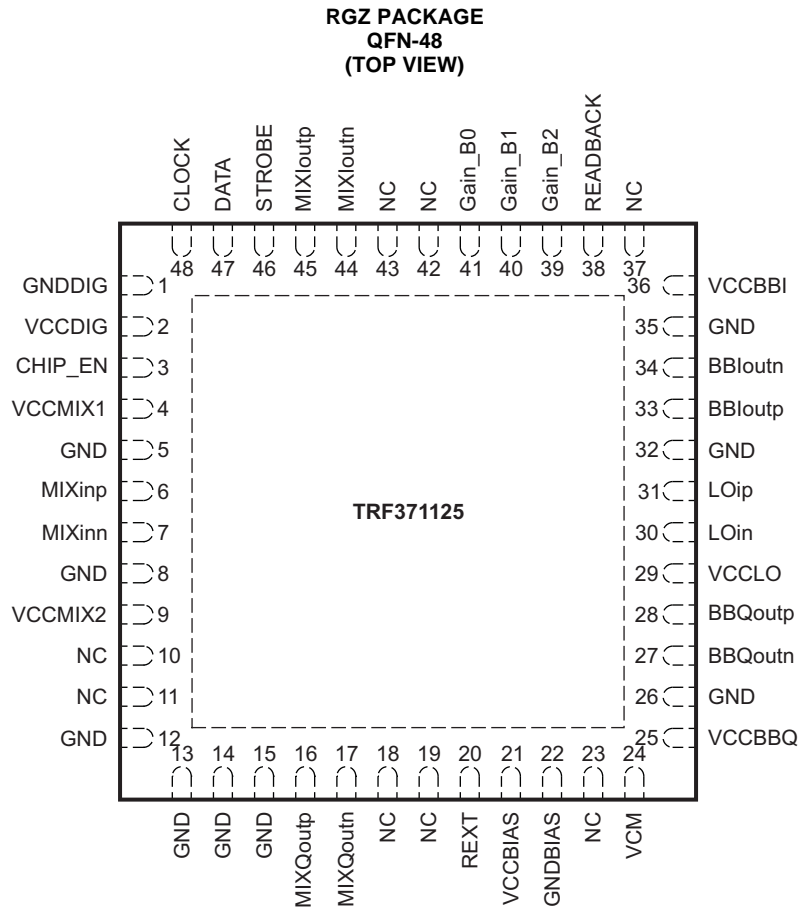

PIN FUNCTIONS

PIN		I/O	DESCRIPTION
NO.	NAME		
1	GNDDIG		Digital ground
2	VCCDIG		Digital power supply
3	CHIP_EN	I	Chip enable
4	VCCMIX1		Mixer power supply
5	GND		Ground
6	MIXinp	I	Mixer input: positive terminal
7	MIXinn	I	Mixer input: negative terminal
8	GND		Ground
9	VCCMIX2		Mixer power supply
10	NC		No connect
11	NC		No connect
12	GND		Ground
13	GND		Ground
14	GND		Ground
15	GND		Ground

**PIN FUNCTIONS (continued)**

PIN		I/O	DESCRIPTION
NO.	NAME		
16	MIXQoutp	O	Mixer Q output: positive terminal
17	MIXQoutn	O	Mixer Q output: negative terminal
18	NC		No connect
19	NC		No connect
20	REXT	O	Reference bias external resistor
21	VCCBIAS		Bias block power supply
22	GNDBIAS		Bias block ground
23	NC		No connect
24	VCM	I	Baseband common-mode input voltage
25	VCCBBQ		Baseband Q chain power supply
26	GND		Ground
27	BBQoutn	O	Baseband Q (in quadrature) output: negative terminal
28	BBQoutp	O	Baseband Q (in quadrature) output: positive terminal
29	VCCLO		Local oscillator power supply
30	LoIn	I	Local oscillator input: negative terminal
31	LoIp	I	Local oscillator input: positive terminal
32	GND		Ground
33	BBIoutp	O	Baseband I (in-phase) output: positive terminal
34	BBIoutn	O	Baseband I (in-phase) output: negative terminal
35	GND		Ground
36	VCCBBI		Baseband I (in phase) power supply
37	NC		No connect
38	READBACK	O	SPI readback data
39	Gain_B2	I	PGA fast gain control bit 2
40	Gain_B1	I	PGA fast gain control bit 1
41	Gain_B0	I	PGA fast gain control bit 0
42	NC		No connect
43	NC		No connect
44	MIXIoutn	O	Mixer I output: negative terminal
45	MIXIoutp	O	Mixer I output: positive terminal
46	STROBE	I	SPI enable
47	DATA	I	SPI data input
48	CLOCK	I	SPI clock input

## ABSOLUTE MAXIMUM RATINGS

 over operating free-air temperature range (unless otherwise noted)<sup>(1)</sup>

	VALUE	UNIT
Supply voltage range <sup>(2)</sup>	–0.3 to 6	V
Digital I/O voltage range	–0.3 to 6	V
Operating free-air temperature range, T <sub>A</sub>	–40 to 85	°C
Operating virtual junction temperature range, T <sub>J</sub>	–40 to 150	°C
Storage temperature range, T <sub>stg</sub>	–65 to 150	°C

- (1) Stresses beyond those listed under *absolute maximum ratings* may cause permanent damage to the device. These are stress ratings only, and functional operation of the device at these or any other conditions beyond those indicated under *recommended operating conditions* is not implied. Exposure to absolute-maximum-rated conditions for extended periods may affect device reliability.
- (2) All voltage values are with respect to network ground terminal.

## RECOMMENDED OPERATING CONDITIONS

over operating free-air temperature range (unless otherwise noted)

	MIN	NOM	MAX	UNIT
V <sub>CC</sub> Power supply voltage	4.5	5	5.5	V
Power supply voltage ripple			940	μVpp
T <sub>A</sub> Operating free-air temperature range	–40		85	°C
T <sub>J</sub> Operating virtual junction temperature range	–40		150	°C

## THERMAL CHARACTERISTICS

over recommended operating free-air temperature range (unless otherwise noted)

PARAMETER <sup>(1)</sup>		TEST CONDITIONS	MIN	TYP	MAX	UNIT
R <sub>θJA</sub>	Thermal resistance, junction-to-ambient	Soldered slug, no airflow		26		°C/W
		Soldered slug, 200-LFM airflow		20.1		
		Soldered slug, 400-LFM airflow		17.4		
R <sub>θJA</sub> <sup>(2)</sup>		7-mm x 7-mm 48-pin PDFP		25		
R <sub>θJB</sub>	Thermal resistance, junction-to-board	7-mm x 7-mm 48-pin PDFP		12		°C/W

- (1) Determined using JEDEC standard JESD-51 with high-K board
- (2) 16 layers, high-K board

## ELECTRICAL CHARACTERISTICS

$V_{CC} = 5\text{ V}$ , LO power = 0 dBm,  $T_A = 25^\circ\text{C}$  (unless otherwise noted)

PARAMETERS		TEST CONDITIONS	MIN	TYP	MAX	UNIT
<b>DC PARAMETERS</b>						
$I_{CC}$	Total supply current			360		mA
	Power-down current			2		mA
<b>IQ DEMODULATOR AND BASEBAND SECTION</b>						
$f_{RF}$	Frequency range		700		4000	MHz
	Gain range		22	24		dB
	Gain step	See <sup>(1)</sup>		1		dB
$P_{in_{max}}$	Max. RF power input	Before damage		25		dBm
OIP3	Output third-order intercept point	Gain setting = 24 <sup>(2)</sup>		30		dBVrms
$P1_{dB_{min}}$	Min. output compression point	1 tone <sup>(3)</sup>		3		dBVrms
$f_{min}$	Min. baseband low-pass filter cutoff frequency	1-dB point <sup>(4)</sup>		700		kHz
$f_{max}$	Max. baseband low-pass filter cutoff frequency	3-dB point <sup>(4)</sup>	15			MHz
$f_{bypass}$	Baseband low-pass filter cutoff frequency in bypass mode	3-dB point <sup>(5)</sup>		30		MHz
$F_{sel}$	Baseband relative attenuation at LPF cutoff frequency ( $f_C$ ) <sup>(6)</sup>	$1 \times f_C$		1		dB
		$1.5 \times f_C$		8		
		$2 \times f_C$		32		
		$3 \times f_C$		54		
		$4 \times f_C$		75		
		$5 \times f_C$		90		
	Image suppression			-40		dB
	Output BB attenuator			3		dB
	Output load impedance	Parallel resistance		1		k $\Omega$
		Parallel capacitance		20		pF
$V_{cm}$	Output, common-mode	Measured at I- and Q-channel baseband outputs		1.5		V
	Baseband harmonic level	Second harmonic <sup>(7)</sup>		-100		dBc
		Third harmonic <sup>(7)</sup>		-93		dBc
<b>LOCAL OSCILLATOR PARAMETERS</b>						
	Local oscillator frequency		700		4000	MHz
	LO input level	See <sup>(8)</sup>	-3	0	6	dBm
	LO leakage	At MIXinn/p at 0-dBm LO drive level			-58	dBm
<b>DIGITAL INTERFACE</b>						
$V_{IH}$	High-level input voltage		$0.6 \times V_{CC}$	5	$V_{CC}$	V
$V_{IL}$	Low-level input voltage		0		0.8	V
$V_{OH}$	High-level output voltage		$0.8 \times V_{CC}$			V
$V_{OL}$	Low-level output voltage				$0.2 \times V_{CC}$	V

- (1) Two consecutive gain settings
- (2) Two CW tones at an offset from LO frequency smaller than the baseband-filter cutoff frequency. Performance is set by baseband circuitry regardless of LO frequency.
- (3) Single CW tone at an offset from LO frequency smaller than the baseband-filter cutoff frequency. Performance is set by baseband circuitry regardless of LO frequency.
- (4) Baseband low-pass filter cutoff frequency is programmable through SPI register LPFADJ. LPFADJ = 0 corresponds to max bandwidth; LPFADJ = 255 corresponds to minimum BW.
- (5) Filter Ctrl setting equal to 0
- (6) Attenuation relative to passband gain
- (7) LO frequency set to 2.4 GHz. Power-in set to -40 dBm. Gain setting at 24. DC offset calibration engaged. Input signal set at 2.5-MHz offset.
- (8) LO power outside of this range is possible but may introduce degraded performance.

## ELECTRICAL CHARACTERISTICS

$V_{CC} = 5\text{ V}$ , LO power = 0 dBm,  $T_A = 25^\circ\text{C}^{(1)}$  (unless otherwise noted)

PARAMETER		TEST CONDITIONS	MIN	TYP	MAX	UNIT
<b><math>f_{LO} = 700\text{ MHz}</math></b>						
$G_{max}$	Maximum gain <sup>(2)</sup>	Gain setting = 24		50		dB
NF	Noise figure	Gain setting = 24		8.5		dB
IIP3	Third-order input intercept point	Gain setting = 24 <sup>(3)(4)</sup>		14		dBm
IIP2	Second-order input intercept point	Gain setting = 24 <sup>(4)(5)</sup>		60		dBm
<b><math>f_{LO} = 1740\text{ MHz}</math></b>						
$G_{max}$	Maximum gain <sup>(2)</sup>	Gain setting = 24		44		dB
NF	Noise figure	Gain setting = 24		11		dB
IIP3	Third-order input intercept point	Gain setting = 24 <sup>(3)(4)</sup>		22		dBm
IIP2	Second-order input intercept point	Gain setting = 24 <sup>(4)(5)</sup>		60		dBm
<b><math>f_{LO} = 1950\text{ MHz}</math></b>						
$G_{max}$	Maximum gain <sup>(2)</sup>	Gain setting = 24		43		dB
NF	Noise figure	Gain setting = 24		12		dB
IIP3	Third-order input intercept point	Gain setting = 24 <sup>(3)(4)</sup>		23		dBm
IIP2	Second-order input intercept point	Gain Setting = 24 <sup>(4)(5)</sup>		60		dBm
<b><math>f_{LO} = 2025\text{ MHz}</math></b>						
$G_{max}$	Maximum gain <sup>(2)</sup>	Gain setting = 24		42.5		dB
N3F	Noise figure	Gain setting = 24		12.5		dB
IIP3	Third-order input intercept point	Gain setting = 24 <sup>(3)(4)</sup>		22		dBm
IIP2	Second-order input intercept point	Gain setting = 24 <sup>(4)(5)</sup>		60		dBm
<b><math>f_{LO} = 2400\text{ MHz}</math></b>						
$G_{max}$	Maximum gain <sup>(2)</sup>	Gain setting = 24		40		dB
NF	Noise figure	Gain setting = 24		13.5		dB
		Gain setting = 16		15		dB
IIP3	Third-order input intercept point	Gain setting = 24 <sup>(3)(4)</sup>		24		dBm
IIP2	Second-order input intercept point	Gain setting = 24 <sup>(4)(5)</sup>		60		dBm

- (1) For broadband frequency sweeps, the Picosecond balun (model #5310A) is used at the RF and LO input. For frequency band between 2100 MHz and 2700 MHz the Murata balun LDB212G4005C-001 is used. Performance parameters adjusted for balun insertion loss. Recommended baluns for respective frequency band is shown below:  
 700 MHz: Murata LDB21897M005C-001 (or equivalent)  
 1740 MHz: Murata LDB211G8005C-001 (or equivalent)  
 1950 MHz: Murata LDB211G9005C-001 (or equivalent)  
 2025 MHz: Murata LDB211G9005C-001 (or equivalent)  
 2500 MHz: Murata LDB212G4005C-001 (or equivalent)  
 3500 MHz: Johanson 3600BL14M050E (or equivalent)
- (2) Gain defined as voltage gain from Mixin ( $V_{rms}$ ) to either baseband output: BBI/Qout ( $V_{rms}$ )
- (3) Two CW tones of  $-30\text{ dBm}$  at  $f_{RF1} = f_{LO} \pm(2 \times f_C)$  and  $f_{RF2} = f_{LO} \pm[(4 \times f_C) + 100\text{ kHz}]$  ( $f_C$  = baseband filter 1-dB cutoff frequency).
- (4) Because the 2-tone interferers are outside of the baseband filter bandwidth, the results are inherently independent of the gain setting. Intermodulation parameters are recorded at maximum gain setting, where measurement accuracy is best.
- (5) Two CW tones at  $-30\text{ dBm}$  at  $f_{RF1} = f_{LO} \pm 2 \times f_C$  and  $f_{RF2} = f_{LO} \pm[(2 \times f_C) + 100\text{ kHz}]$ ; IM2 product measured at 100-kHz output frequency ( $f_C$  = baseband filter 1-dB cutoff frequency)

## TIMING REQUIREMENTS

$V_{CC} = 5\text{ V}$ , LO power = 0 dBm,  $T_A = 25^\circ\text{C}$  (unless otherwise noted)

PARAMETER		TEST CONDITIONS	MIN	TYP	MAX	UNIT
$t_{CLK}$	Clock period		50			ns
$t_{su1}$	Setup time, data		10			ns
$t_h$	Hold time, data		10			ns
$t_w$	Pulse width, STROBE		20			ns
$t_{su2}$	Setup time, STROBE		10			ns

## TYPICAL CHARACTERISTICS

$V_{CC} = 5\text{ V}$ , LO power = 0 dBm,  $T_A = 25^\circ\text{C}$ , balun = Murata LDB212G4005C-001 (unless otherwise noted)

### Table of Graphs

Gain	vs LO frequency <sup>(1)(2)</sup>	Figure 1, Figure 2, Figure 3
Noise figure	vs LO frequency <sup>(1)(2)</sup>	Figure 4, Figure 5, Figure 6
IIP3	vs LO frequency <sup>(3)(4)(5)</sup>	Figure 7, Figure 8, Figure 9
IIP2	vs LO frequency <sup>(3)(4)(5)</sup>	Figure 10, Figure 11, Figure 12
Gain	vs LO frequency	Figure 13, Figure 14, Figure 15
IIP3	vs LO frequency <sup>(4)(5)</sup>	Figure 16, Figure 17, Figure 18, Figure 19
IIP2	vs LO frequency <sup>(4)(5)</sup>	Figure 20, Figure 21, Figure 22, Figure 23
Optimized IIP2	vs LO frequency <sup>(4)(5)(6)</sup>	Figure 24
Optimized IIP3	vs LO frequency <sup>(4)(5)(6)</sup>	Figure 25
Noise figure	vs LO frequency	Figure 26, Figure 27, Figure 28
OIP3	vs Frequency offset <sup>(7)</sup>	Figure 29, Figure 30, Figure 31, Figure 32
Noise figure	vs BB gain setting	Figure 33
Gain	vs BB gain setting	Figure 34
Gain	vs Frequency offset	Figure 35, Figure 36
Gain	vs Frequency offset (bypass mode)	Figure 37, Figure 38
1-dB LPF corner frequency	vs LPFADJ setting	Figure 39
Relative LPF group delay	vs Frequency offset <sup>(8)</sup>	Figure 40
Image rejection	vs BB frequency offset	Figure 41
DC offset limit	vs Temperature <sup>(9)</sup>	Figure 42
Out-of-band P1dB	vs Relative offset multiplier to corner frequency <sup>(10)</sup>	Figure 43

- (1) Measured with broadband Picosecond 5310A balun on the LO input and single ended connection on the RF input. Performance gain adjusted for the 3 dB differential to single-ended insertion loss.
- (2) Performance ripple due to impedance mismatch on the RF input.
- (3) Measured with broadband Picosecond 5310A balun on the LO input and RF input. Balun insertion loss is compensated for in the measurement.
- (4) Out-of-band intercept point is defined with tones that are at least 2 times farther out than the programmed LPF corner frequency that generate an intermodulation tone that falls inside the LPF passband.
- (5) Out-of-band intercept point is dependent on the demodulator performance and not the baseband circuitry; the measurement is taken at max gain but is valid across all PGA settings.
- (6) Optimized intercept point within the band 2.5 to 2.7 GHz is achieved by setting trim values Mix GM trim, Mix LO Trim, LO Trim, Mix Buff Trim, Filter trim, Out Buff Trim to: 2, 3, 0, 1, 2, 1 respectively.
- (7) Measured with filter in bypass mode to characterize the passband circuitry across baseband frequencies.
- (8) Relative to the low frequency offset group delay in bypass mode.
- (9) Idet set to 50  $\mu\text{A}$ ; RF signal is off; LO at 2.4 GHz at 0 dBm; Det filter set to 1 kHz; Clk Div set to 1024.
- (10) In-band tone set to 1 MHz; out-of-band jammer tone set to specified relative offset ratio from the programmed corner frequency. Jammer tone is increased until in-band tone compresses 1 dB.



**TYPICAL CHARACTERISTICS**

$V_{CC} = 5\text{ V}$ , LO power = 0 dBm,  $T_A = 25^\circ\text{C}$ , balun = Murata LDB212G4005C-001 (unless otherwise noted)

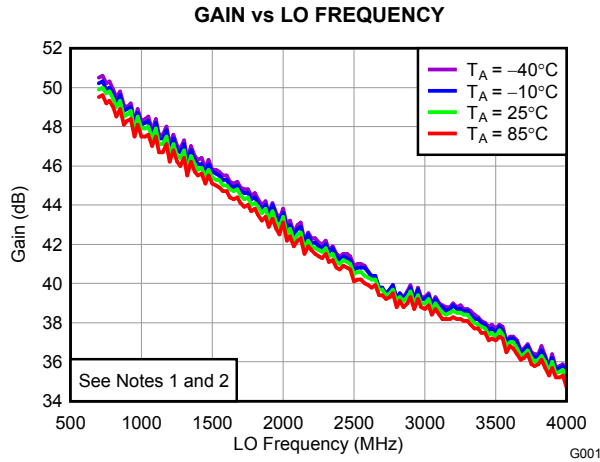

Figure 1.

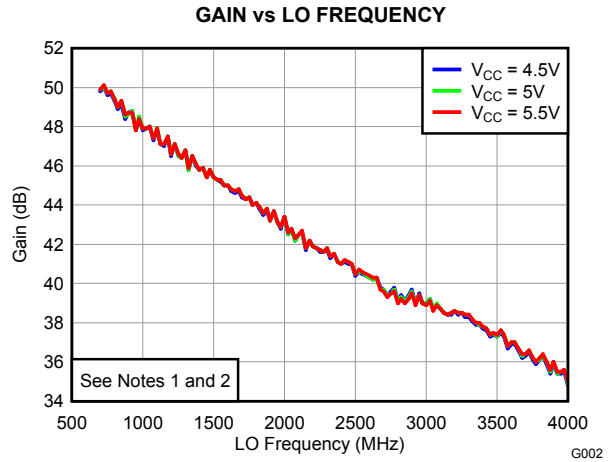

Figure 2.

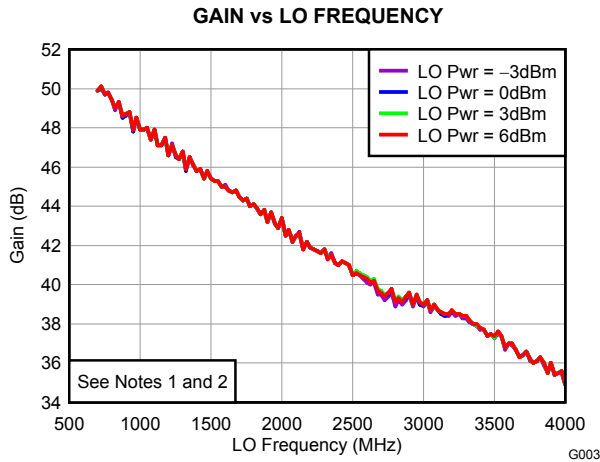

Figure 3.

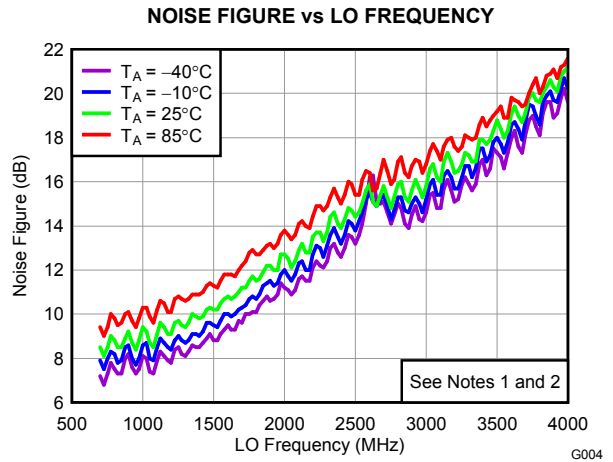

Figure 4.

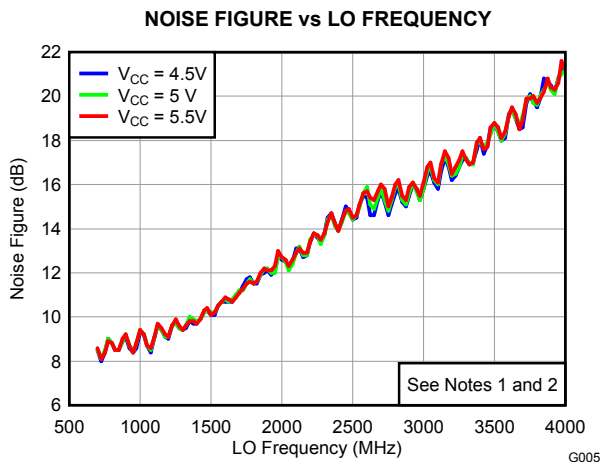

Figure 5.

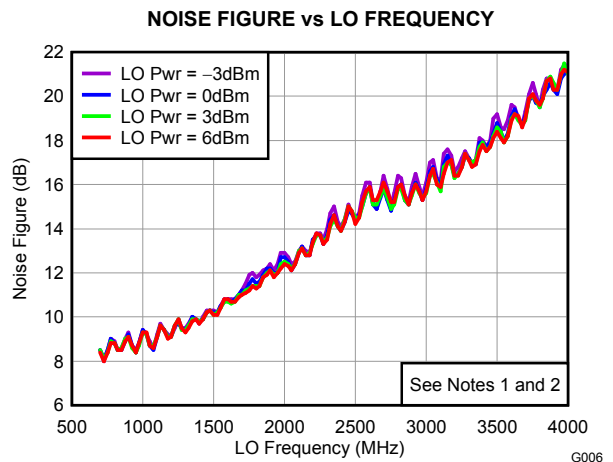

Figure 6.

**TYPICAL CHARACTERISTICS (continued)**

$V_{CC} = 5\text{ V}$ , LO power = 0 dBm,  $T_A = 25^\circ\text{C}$ , balun = Murata LDB212G4005C-001 (unless otherwise noted)

**IIP3 vs LO FREQUENCY**

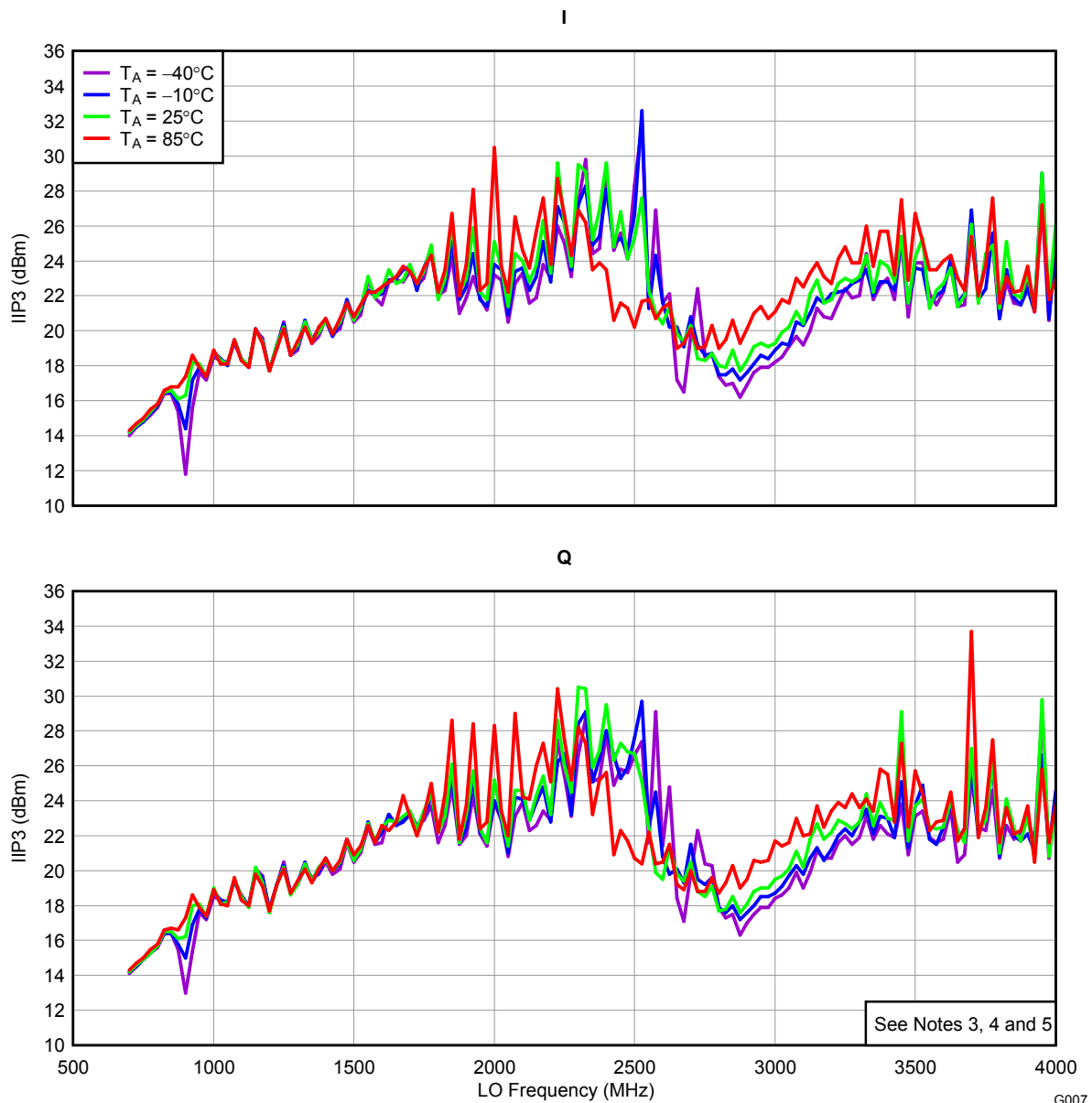

Figure 7.

**TYPICAL CHARACTERISTICS (continued)**

$V_{CC} = 5\text{ V}$ , LO power = 0 dBm,  $T_A = 25^\circ\text{C}$ , balun = Murata LDB212G4005C-001 (unless otherwise noted)

**IIP3 vs LO FREQUENCY**

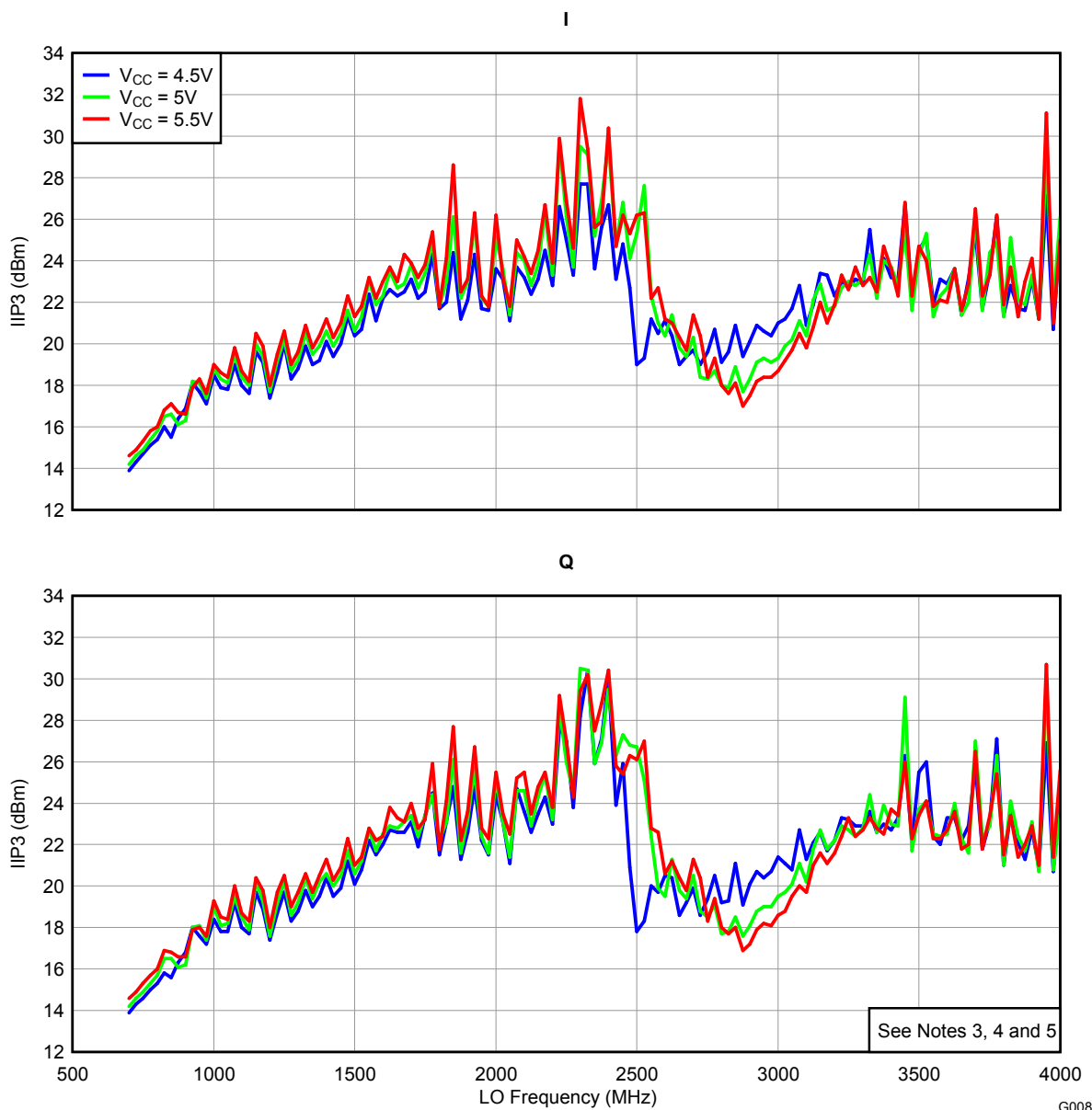

Figure 8.

**TYPICAL CHARACTERISTICS (continued)**

$V_{CC} = 5\text{ V}$ , LO power = 0 dBm,  $T_A = 25^\circ\text{C}$ , balun = Murata LDB212G4005C-001 (unless otherwise noted)

**IIP3 vs LO FREQUENCY**

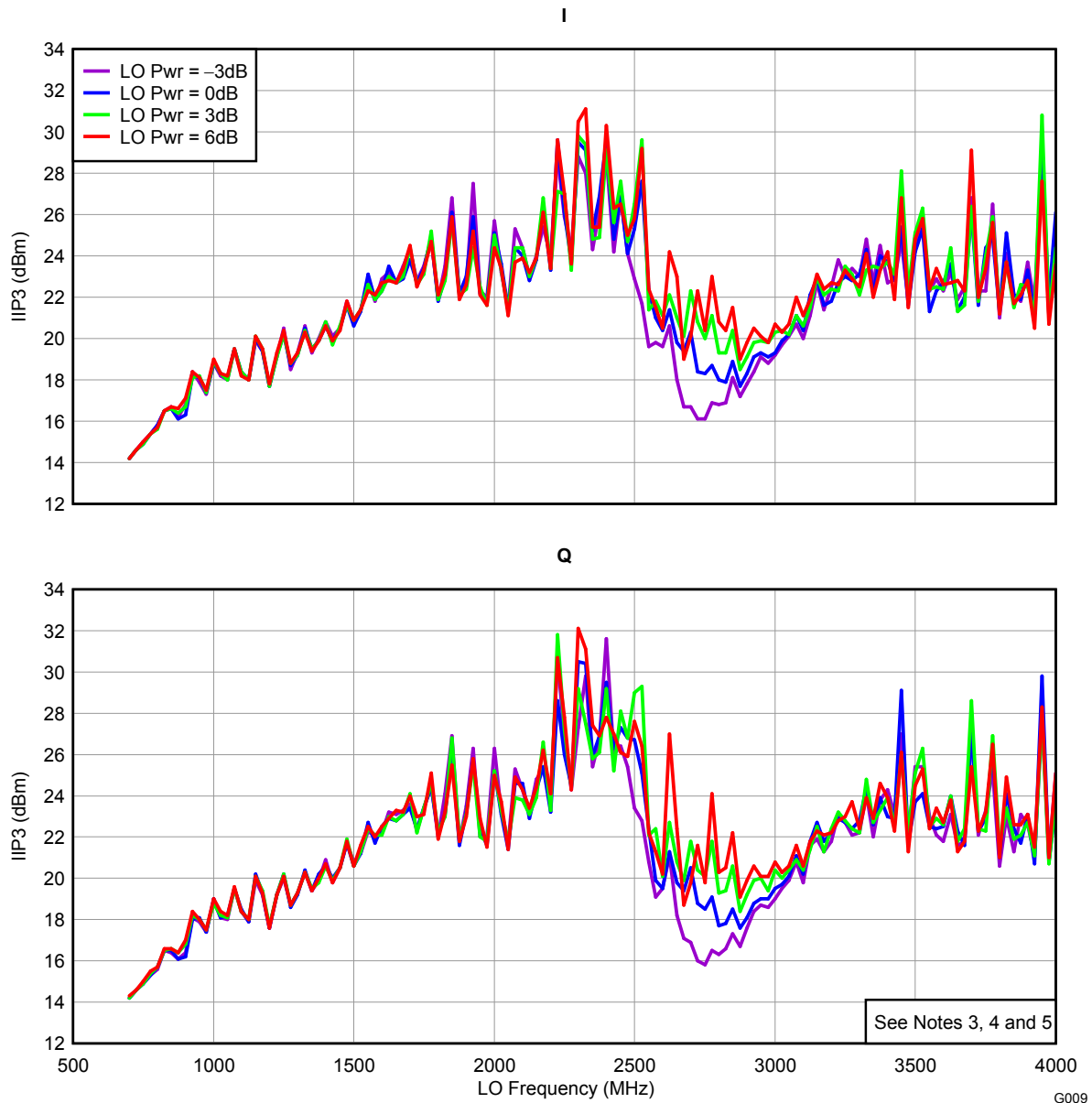

Figure 9.

**TYPICAL CHARACTERISTICS (continued)**

$V_{CC} = 5\text{ V}$ , LO power = 0 dBm,  $T_A = 25^\circ\text{C}$ , balun = Murata LDB212G4005C-001 (unless otherwise noted)

**IIP2 vs LO FREQUENCY**

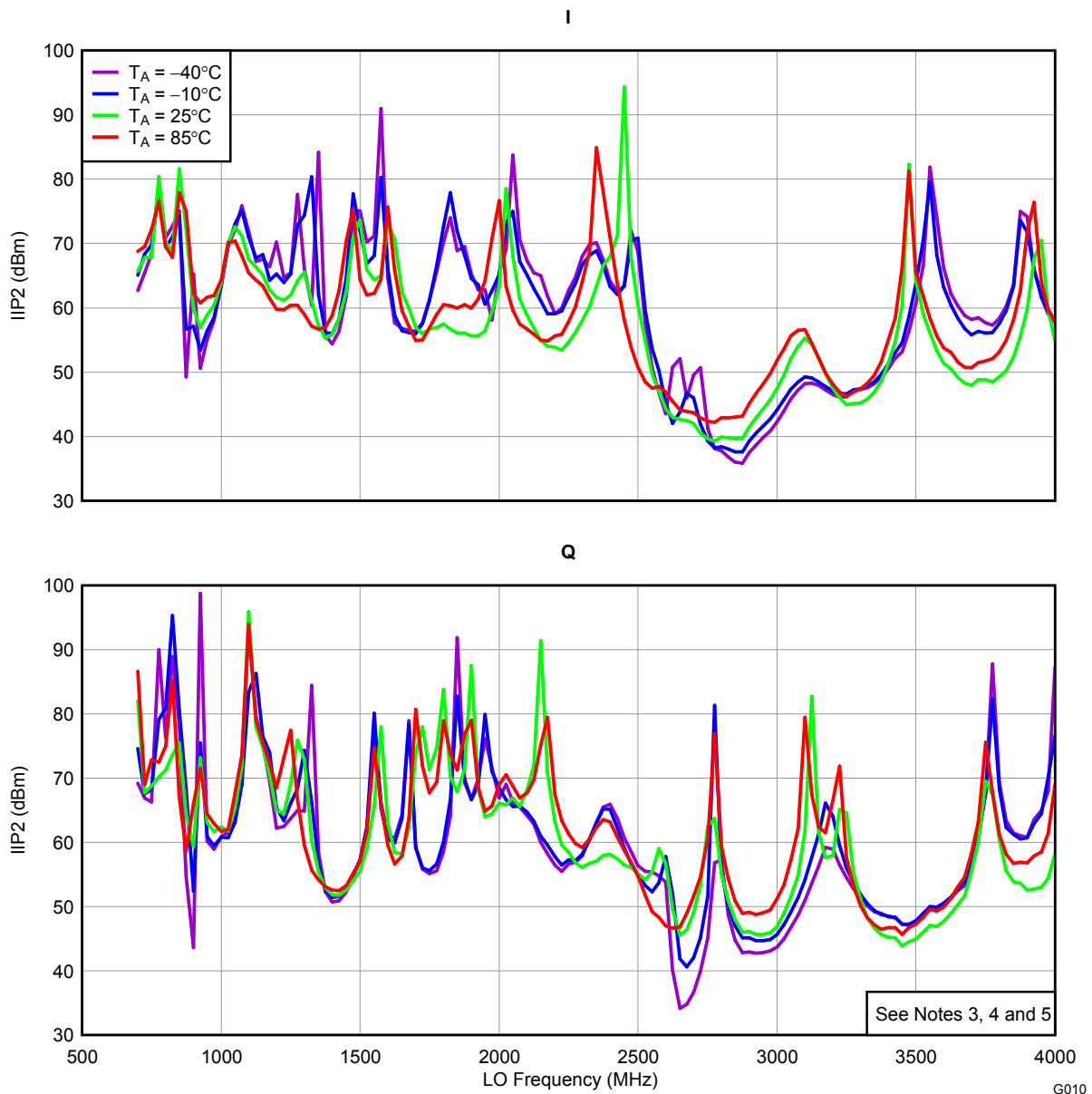

Figure 10.

**TYPICAL CHARACTERISTICS (continued)**

$V_{CC} = 5\text{ V}$ , LO power = 0 dBm,  $T_A = 25^\circ\text{C}$ , balun = Murata LDB212G4005C-001 (unless otherwise noted)

**IIP2 vs LO FREQUENCY**

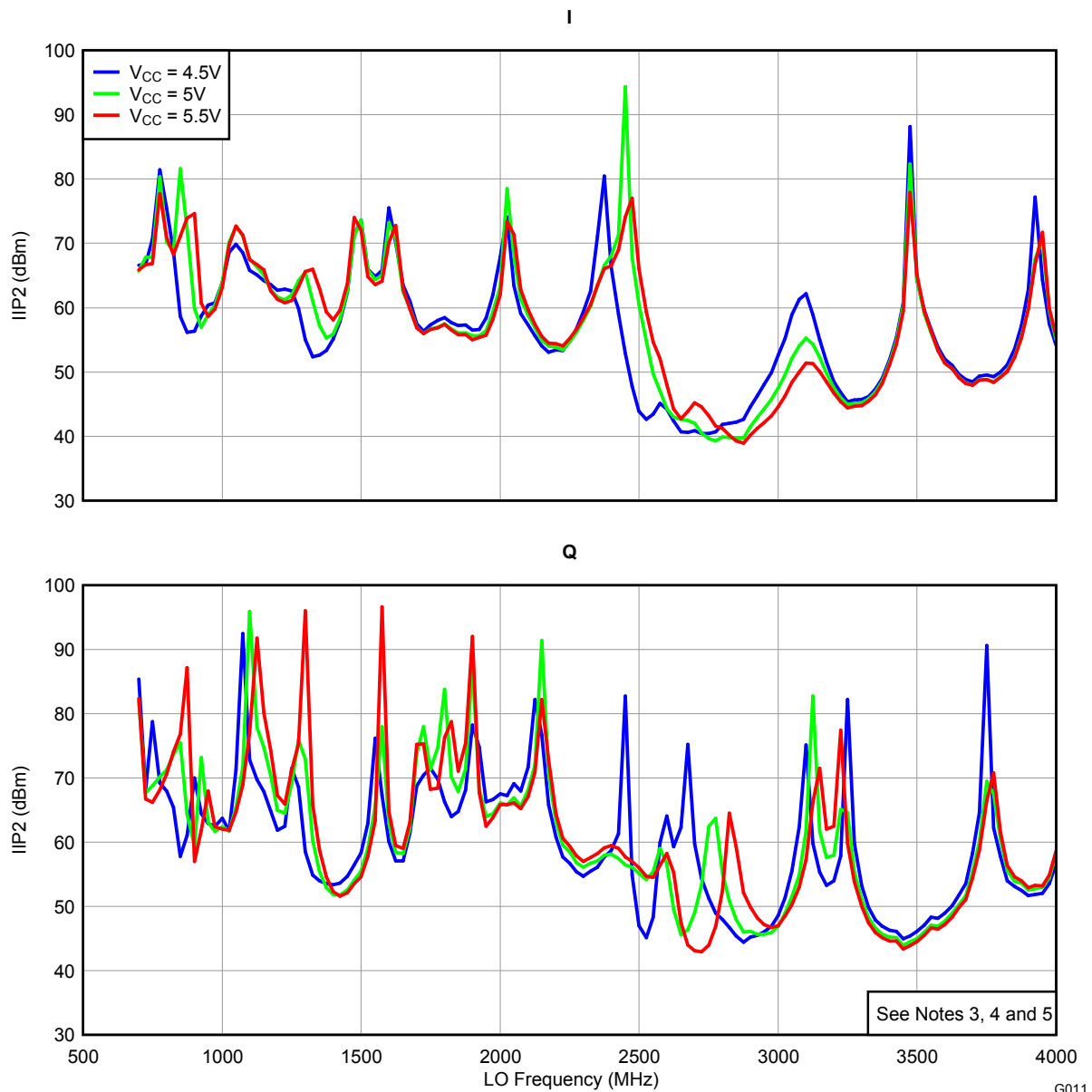

Figure 11.

G011

**TYPICAL CHARACTERISTICS (continued)**

$V_{CC} = 5\text{ V}$ , LO power = 0 dBm,  $T_A = 25^\circ\text{C}$ , balun = Murata LDB212G4005C-001 (unless otherwise noted)

**IIP2 vs LO FREQUENCY**

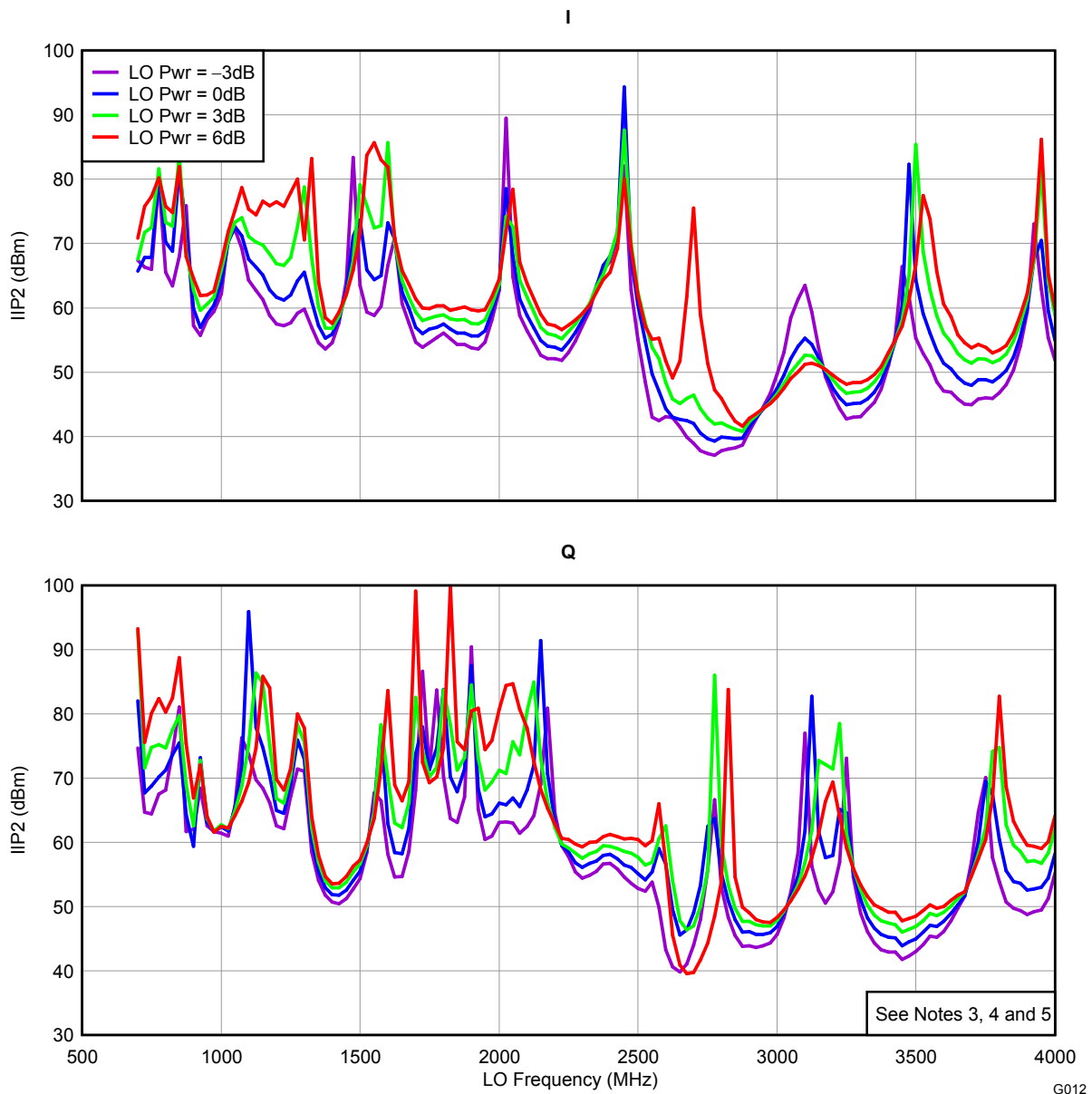

**Figure 12.**

**TYPICAL CHARACTERISTICS (continued)**

$V_{CC} = 5\text{ V}$ , LO power = 0 dBm,  $T_A = 25^\circ\text{C}$ , balun = Murata LDB212G4005C-001 (unless otherwise noted)

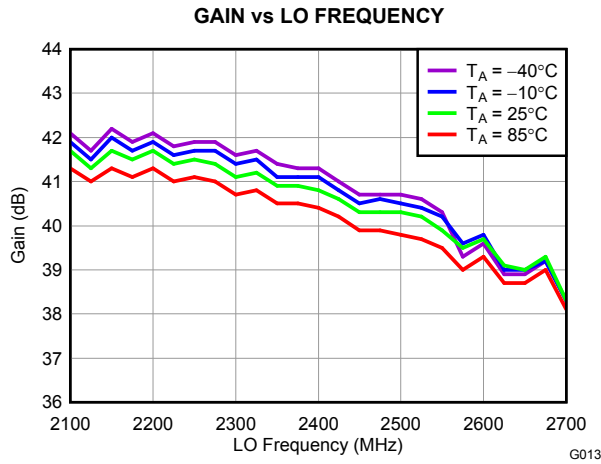

Figure 13.

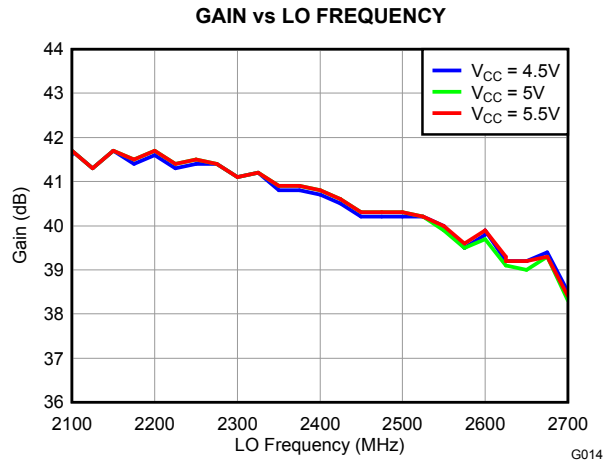

Figure 14.

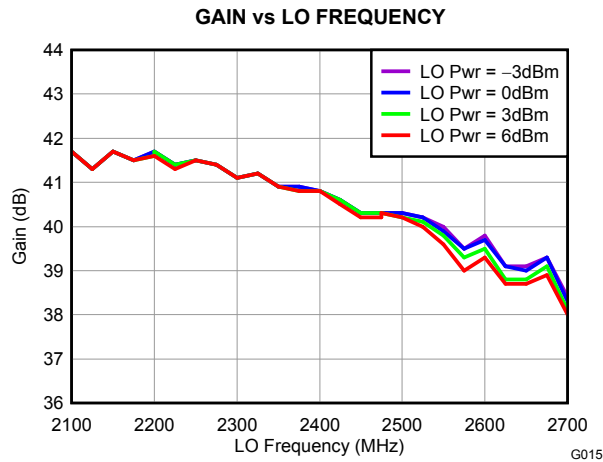

Figure 15.



**TYPICAL CHARACTERISTICS (continued)**

$V_{CC} = 5\text{ V}$ , LO power = 0 dBm,  $T_A = 25^\circ\text{C}$ , balun = Murata LDB212G4005C-001 (unless otherwise noted)

**IIP3 vs LO FREQUENCY**

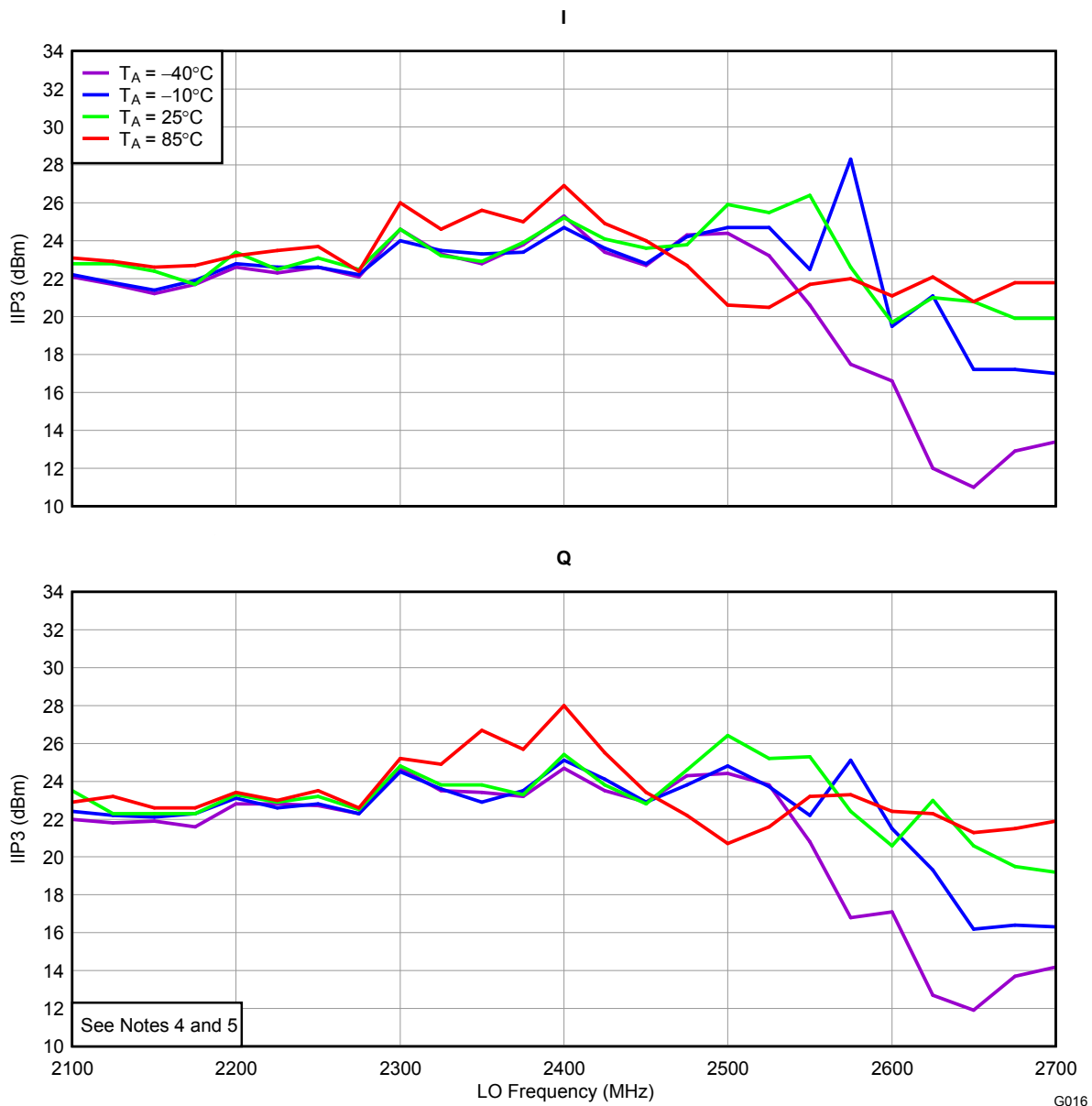

Figure 16.

G016

**TYPICAL CHARACTERISTICS (continued)**

$V_{CC} = 5\text{ V}$ , LO power = 0 dBm,  $T_A = 25^\circ\text{C}$ , balun = Murata LDB212G4005C-001 (unless otherwise noted)

**IIP3 vs LO FREQUENCY**

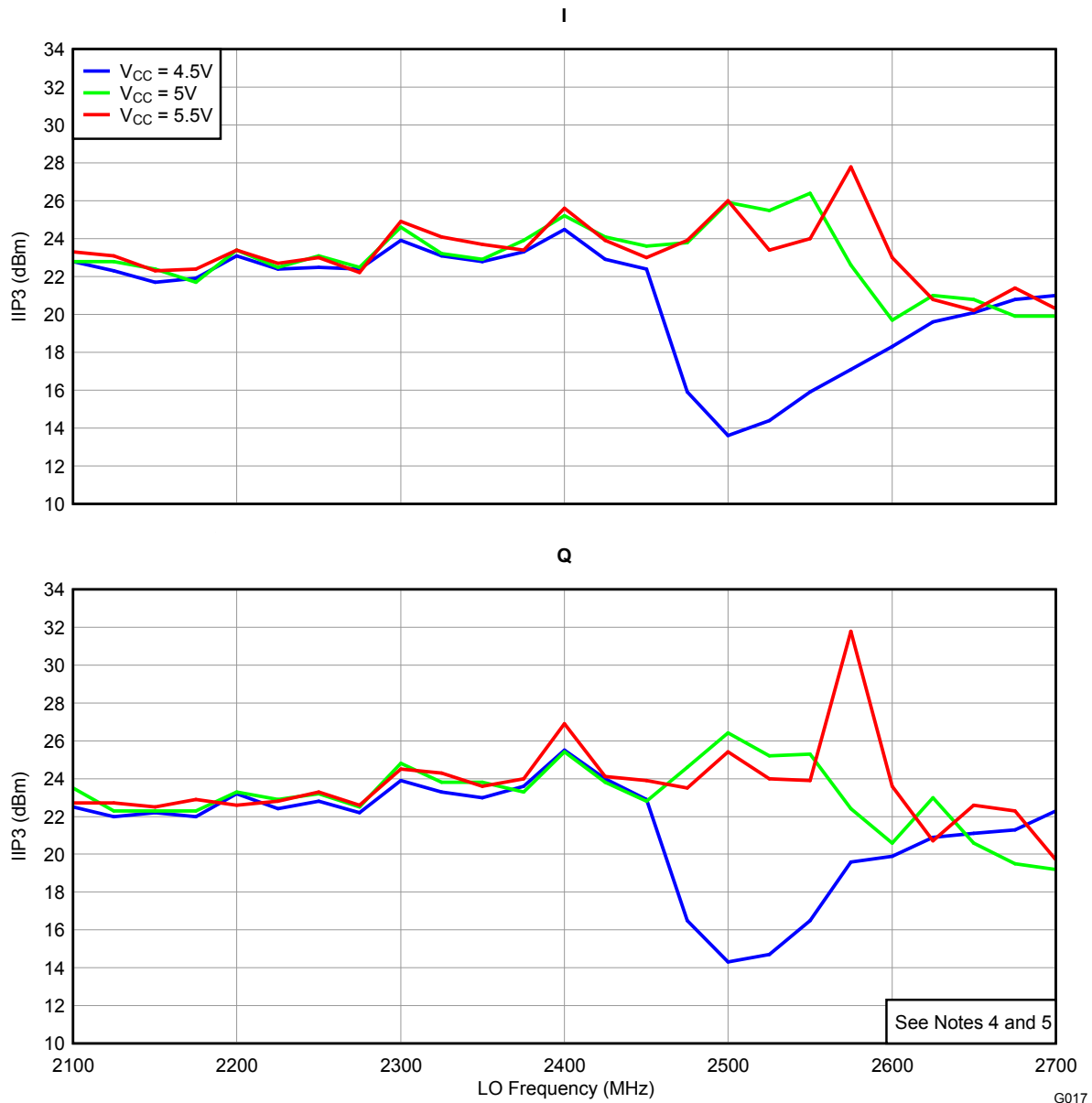

Figure 17.

**TYPICAL CHARACTERISTICS (continued)**

$V_{CC} = 5\text{ V}$ , LO power = 0 dBm,  $T_A = 25^\circ\text{C}$ , balun = Murata LDB212G4005C-001 (unless otherwise noted)

**IIP3 vs LO FREQUENCY**

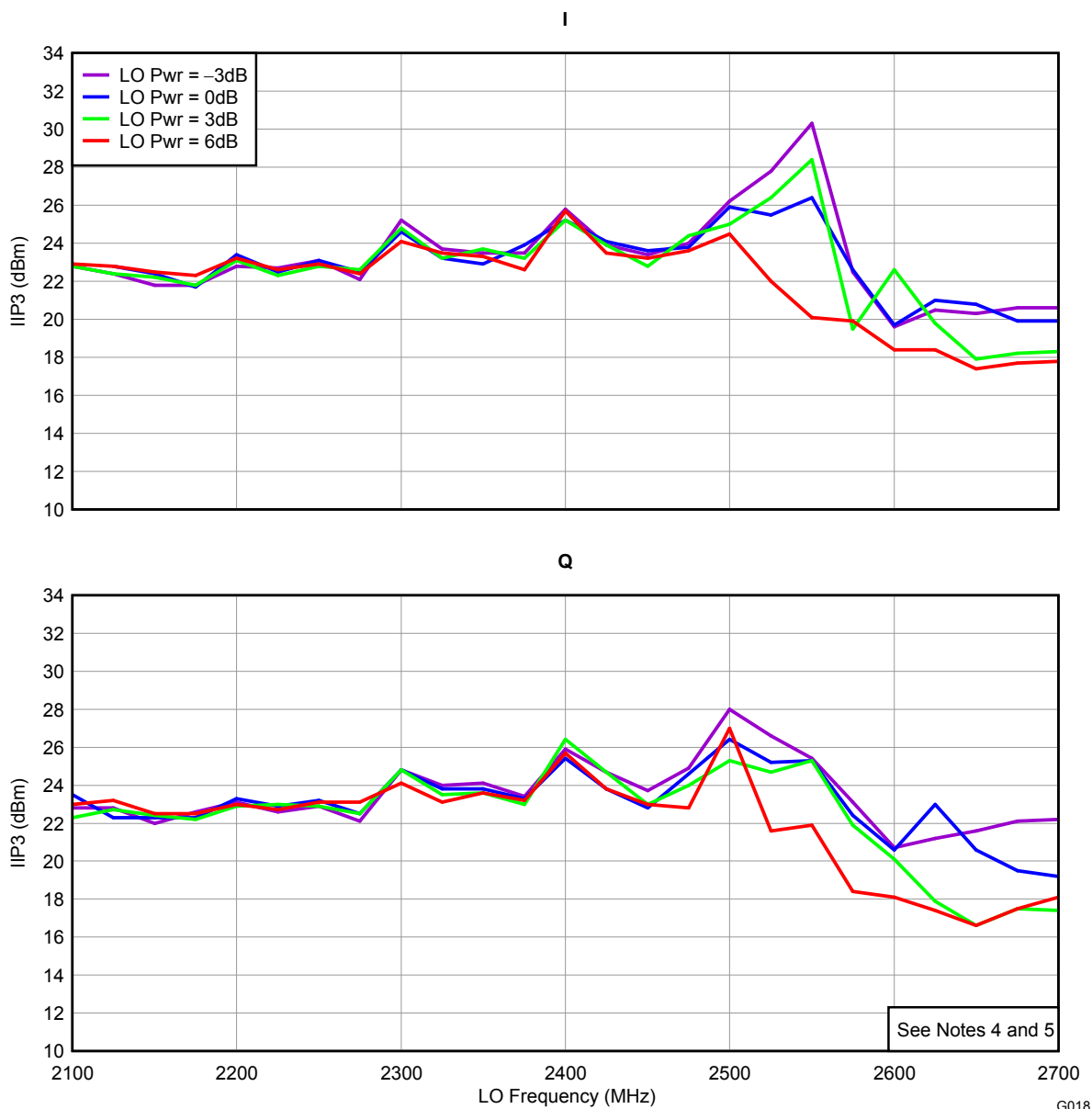

Figure 18.

**TYPICAL CHARACTERISTICS (continued)**

V<sub>CC</sub> = 5 V, LO power = 0 dBm, T<sub>A</sub> = 25°C, balun = Murata LDB212G4005C-001 (unless otherwise noted)

**IIP3 vs LO FREQUENCY**

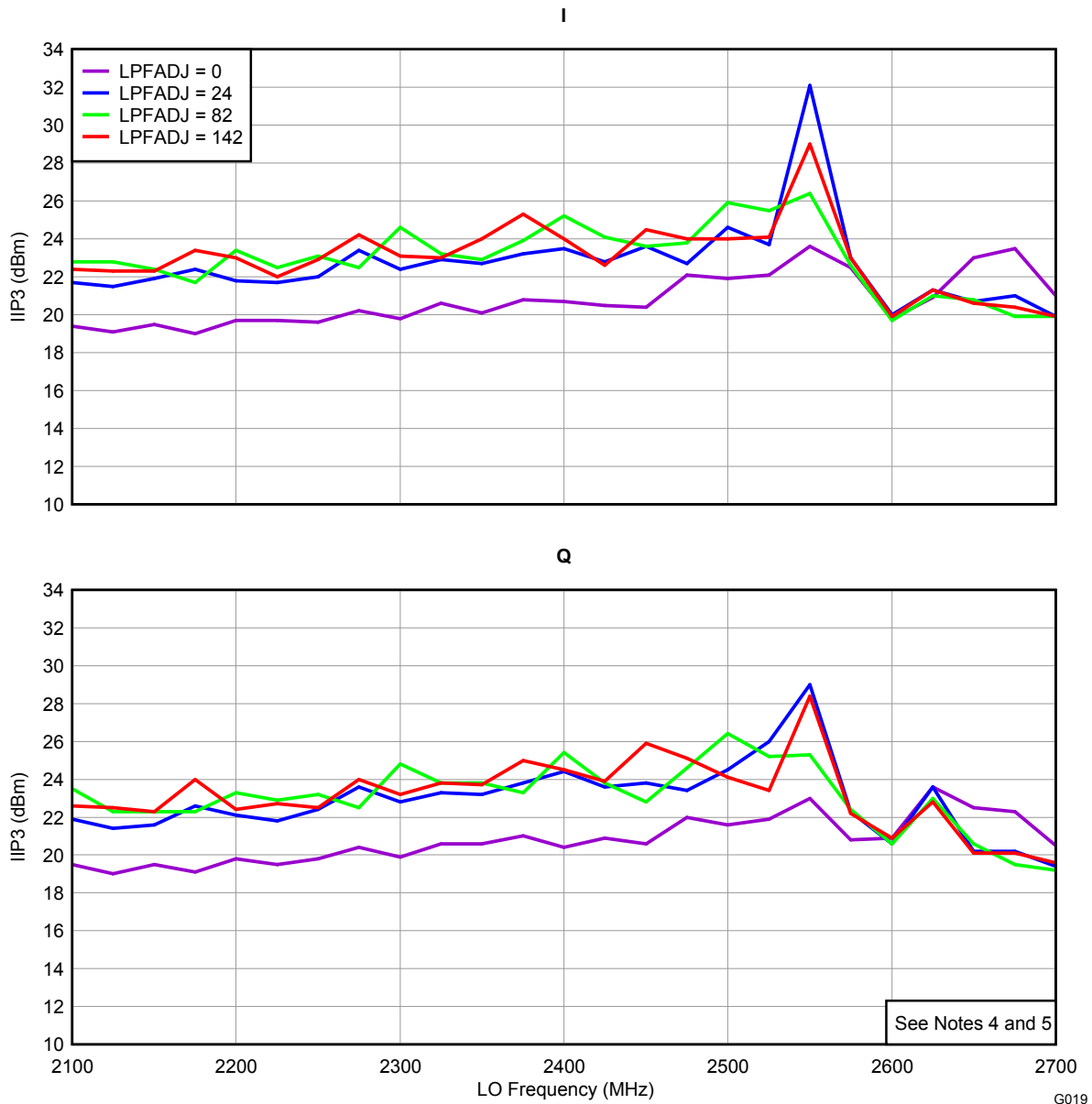

Figure 19.

**TYPICAL CHARACTERISTICS (continued)**

$V_{CC} = 5\text{ V}$ , LO power = 0 dBm,  $T_A = 25^\circ\text{C}$ , balun = Murata LDB212G4005C-001 (unless otherwise noted)

**IIP2 vs LO FREQUENCY**

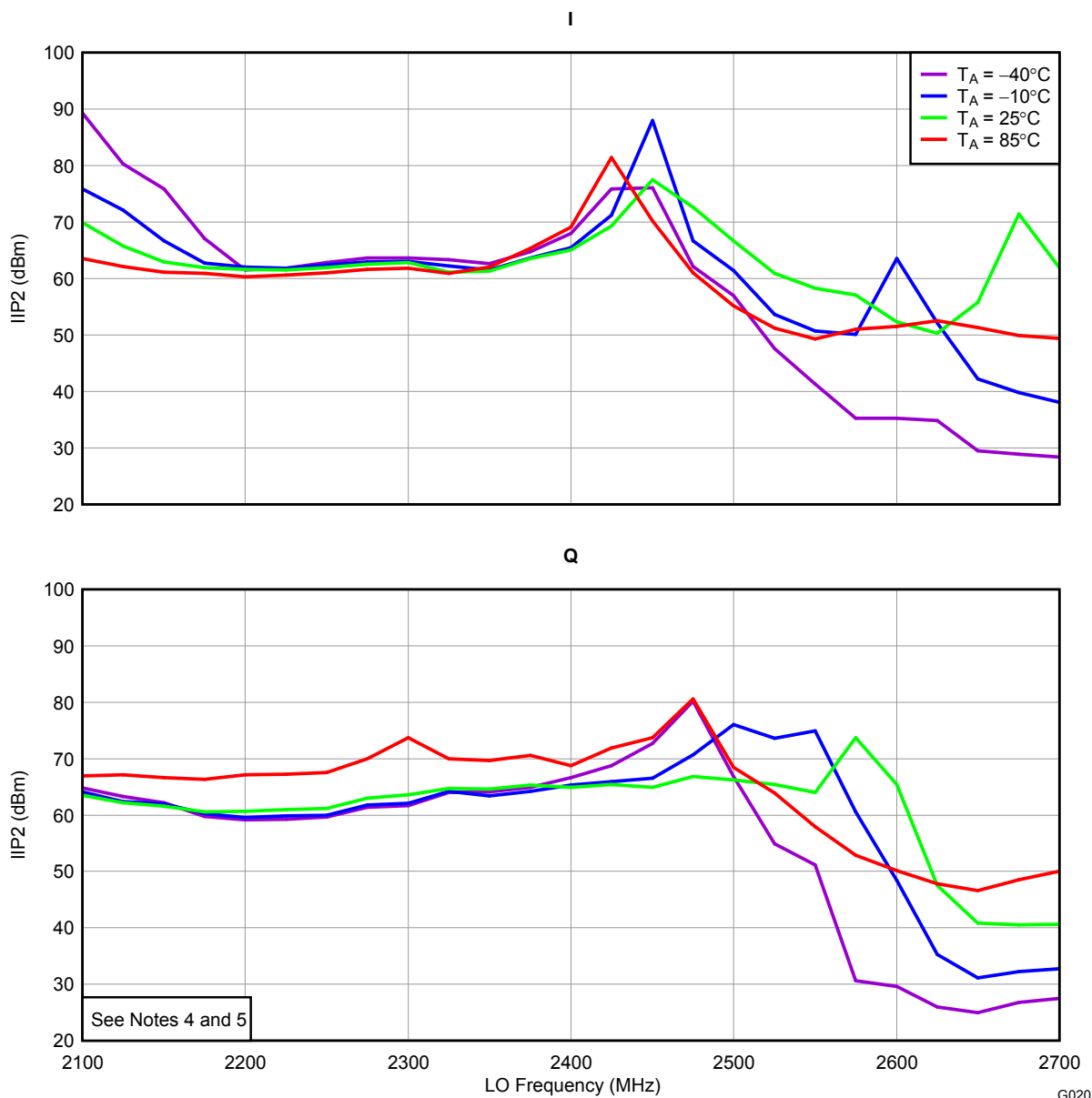
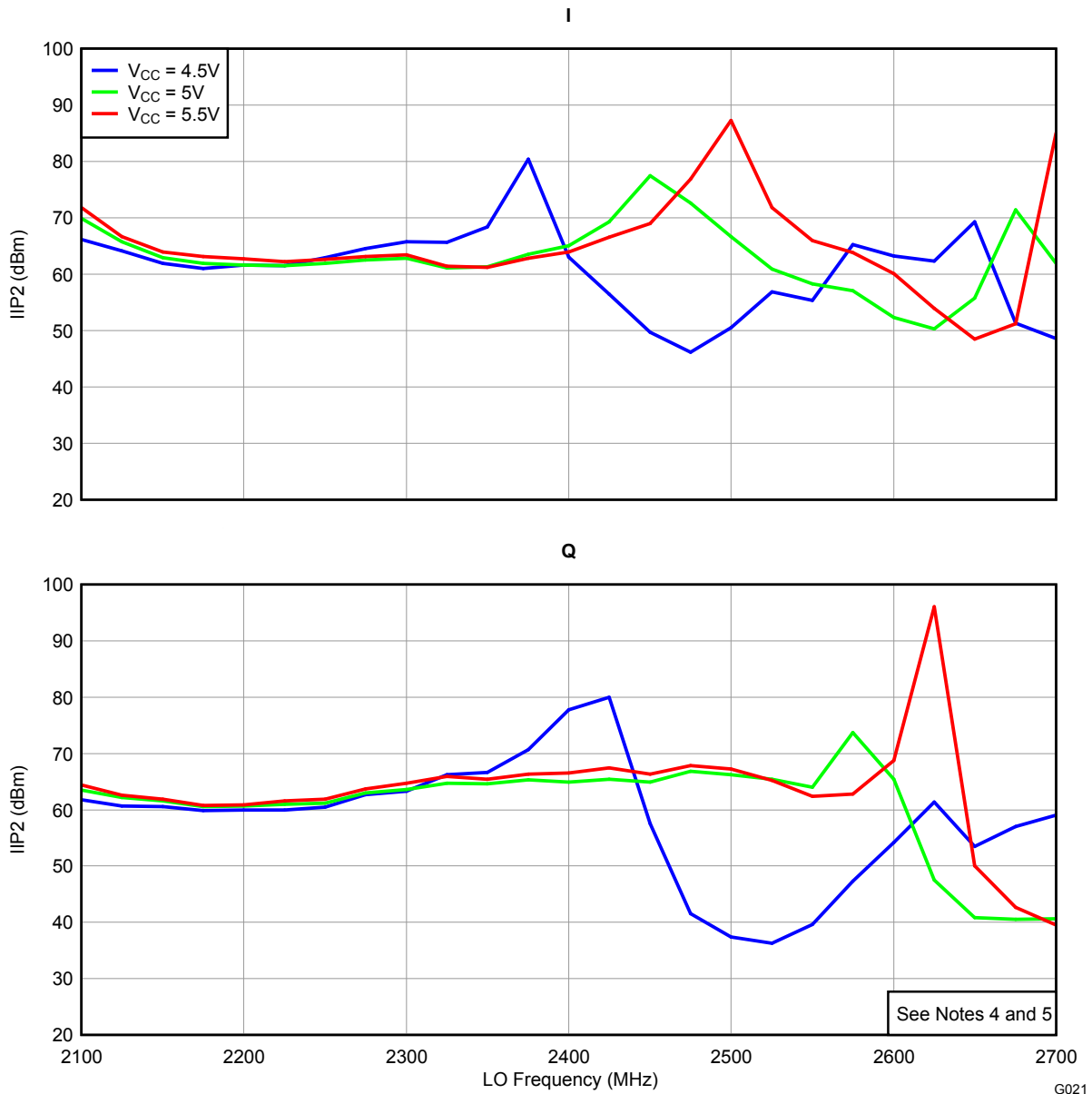

Figure 20.

**TYPICAL CHARACTERISTICS (continued)**

$V_{CC} = 5\text{ V}$ , LO power = 0 dBm,  $T_A = 25^\circ\text{C}$ , balun = Murata LDB212G4005C-001 (unless otherwise noted)

**IIP2 vs LO FREQUENCY**

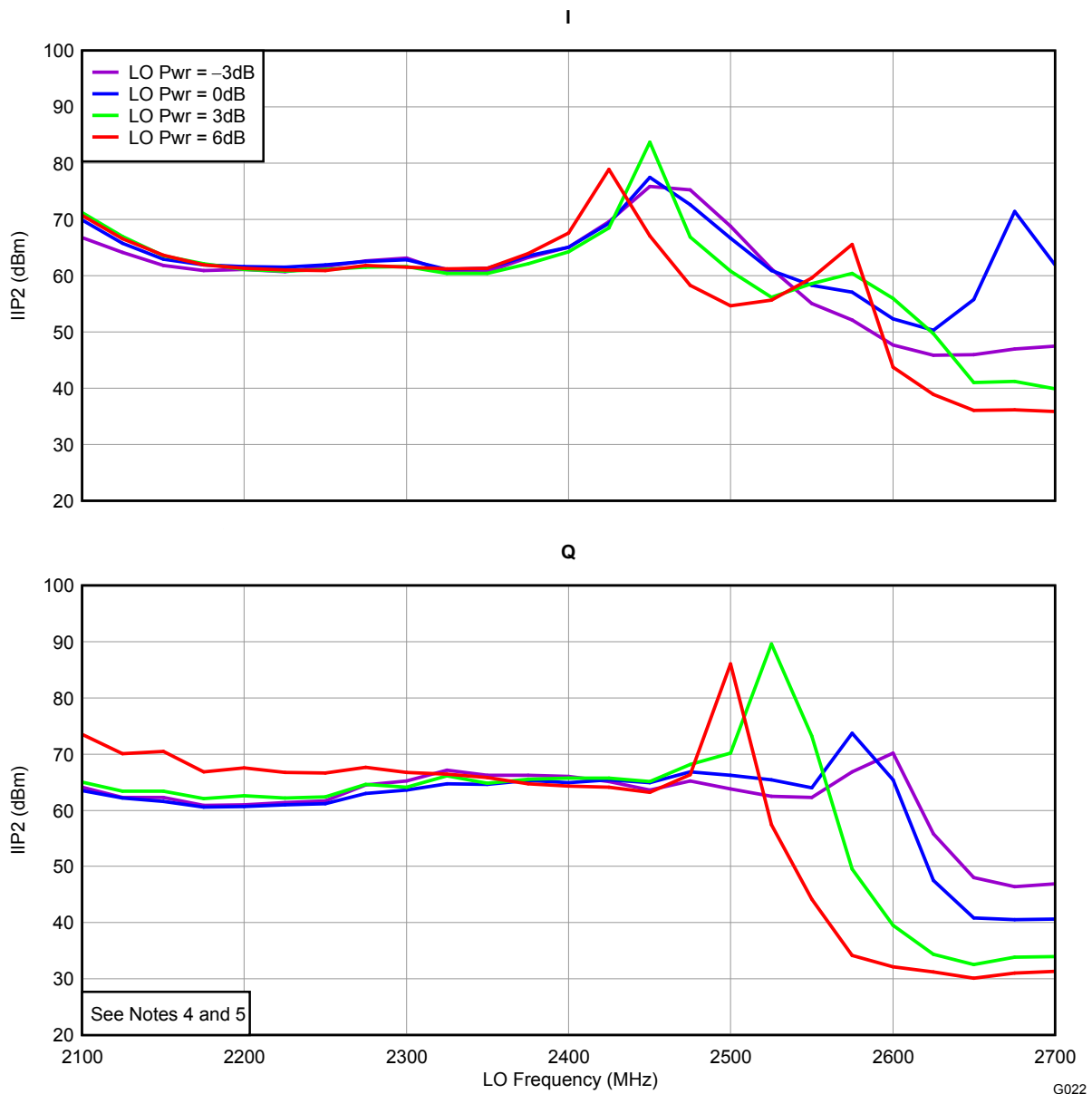

**Figure 21.**

**TYPICAL CHARACTERISTICS (continued)**

$V_{CC} = 5\text{ V}$ , LO power = 0 dBm,  $T_A = 25^\circ\text{C}$ , balun = Murata LDB212G4005C-001 (unless otherwise noted)

**IIP2 vs LO FREQUENCY**

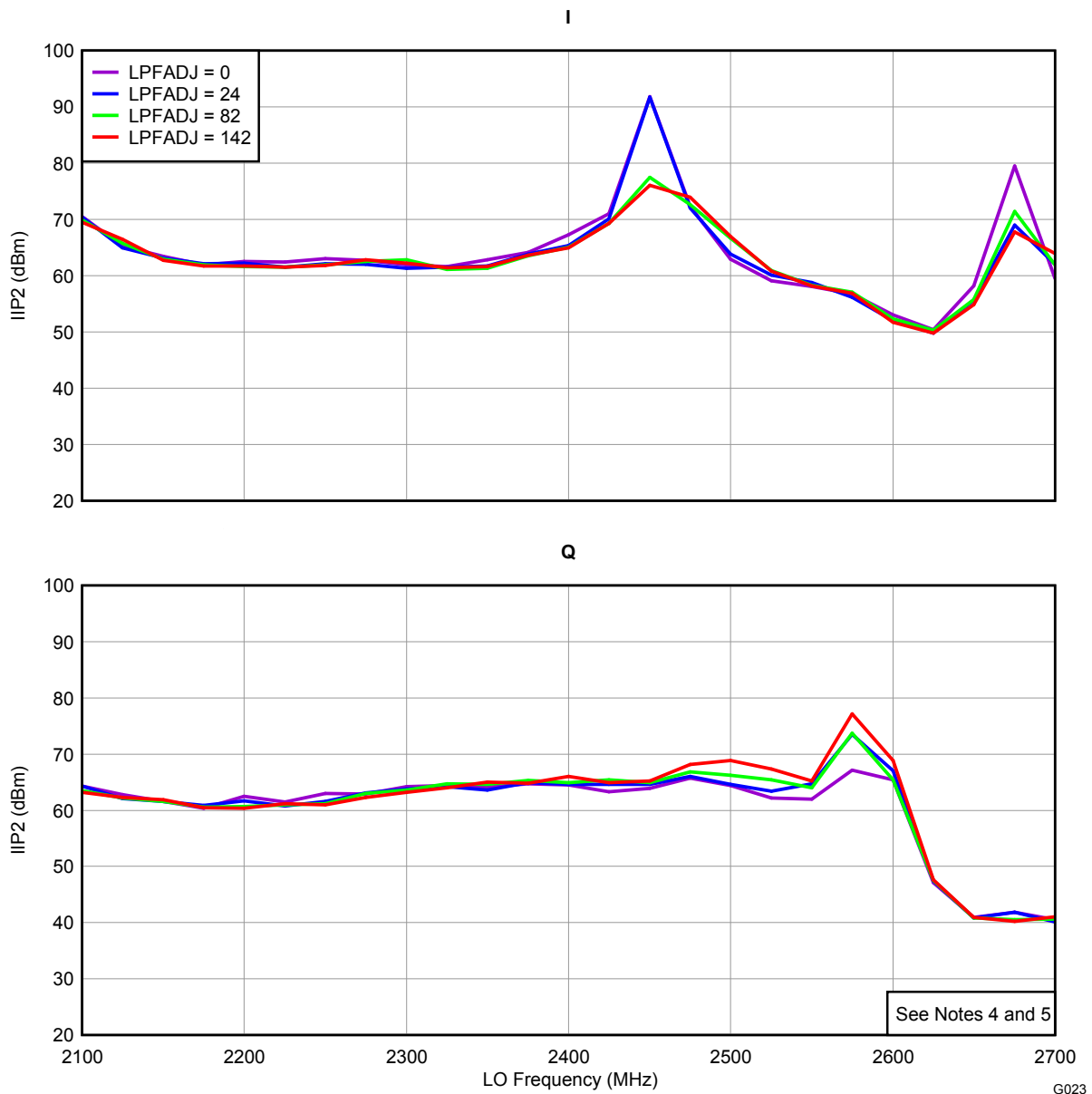

**Figure 22.**

**TYPICAL CHARACTERISTICS (continued)**

$V_{CC} = 5\text{ V}$ , LO power = 0 dBm,  $T_A = 25^\circ\text{C}$ , balun = Murata LDB212G4005C-001 (unless otherwise noted)

**IIP2 vs LO FREQUENCY**



**Figure 23.**

G023



**TYPICAL CHARACTERISTICS (continued)**

$V_{CC} = 5\text{ V}$ , LO power = 0 dBm,  $T_A = 25^\circ\text{C}$ , balun = Murata LDB212G4005C-001 (unless otherwise noted)

**OPTIMIZED IIP2 vs LO FREQUENCY**

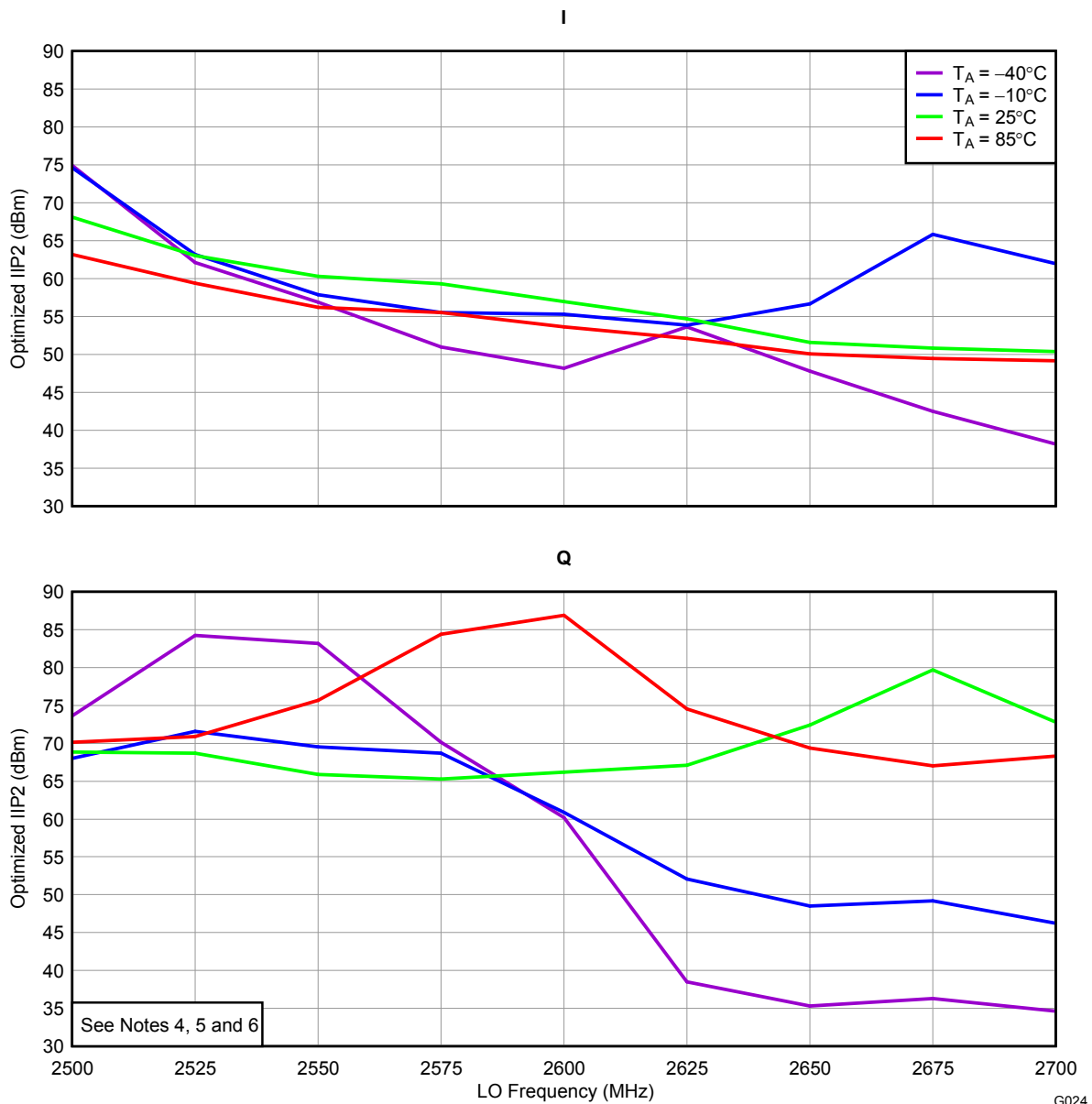

Figure 24.

**TYPICAL CHARACTERISTICS (continued)**

$V_{CC} = 5\text{ V}$ , LO power = 0 dBm,  $T_A = 25^\circ\text{C}$ , balun = Murata LDB212G4005C-001 (unless otherwise noted)

**OPTIMIZED IIP3 vs LO FREQUENCY**

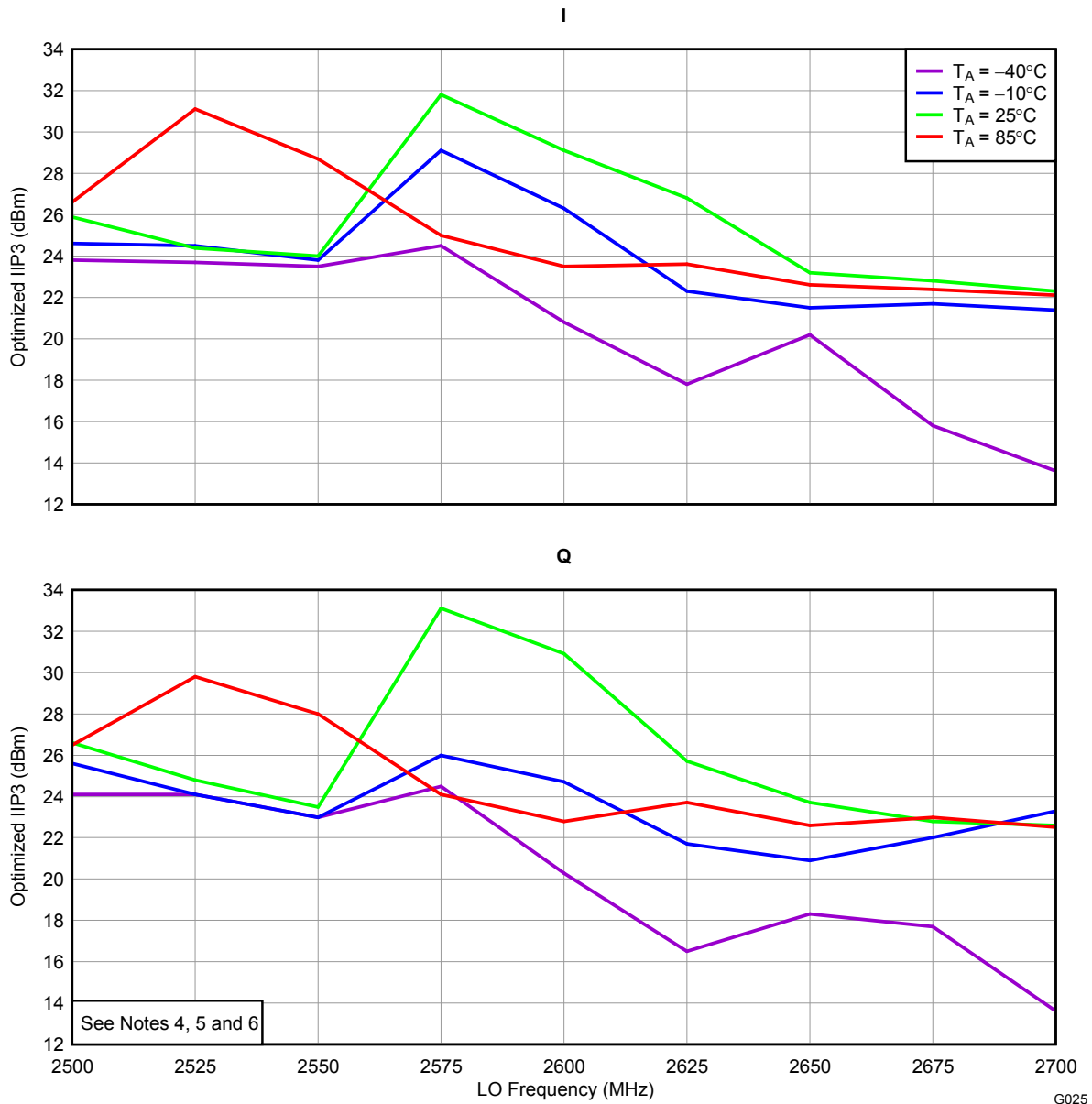

Figure 25.

G025

**TYPICAL CHARACTERISTICS (continued)**

$V_{CC} = 5\text{ V}$ , LO power = 0 dBm,  $T_A = 25^\circ\text{C}$ , balun = Murata LDB212G4005C-001 (unless otherwise noted)

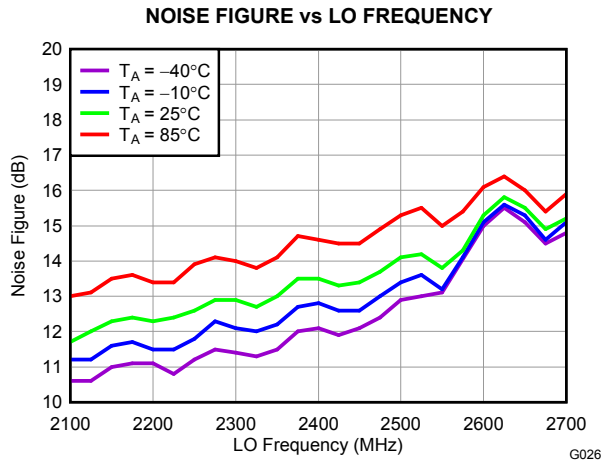

Figure 26.

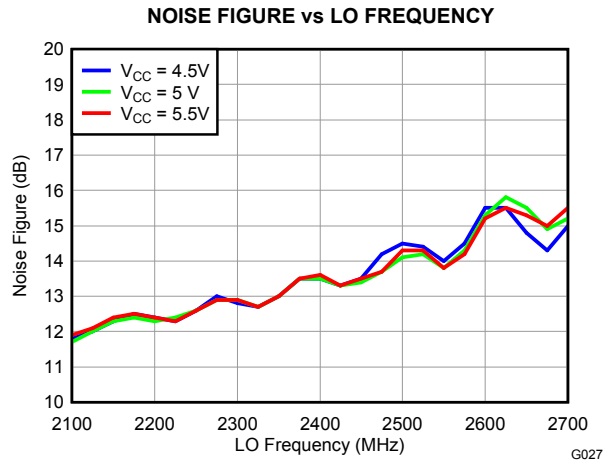

Figure 27.

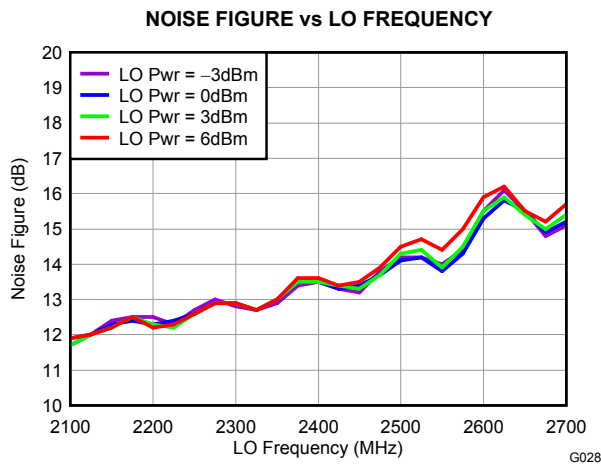

Figure 28.

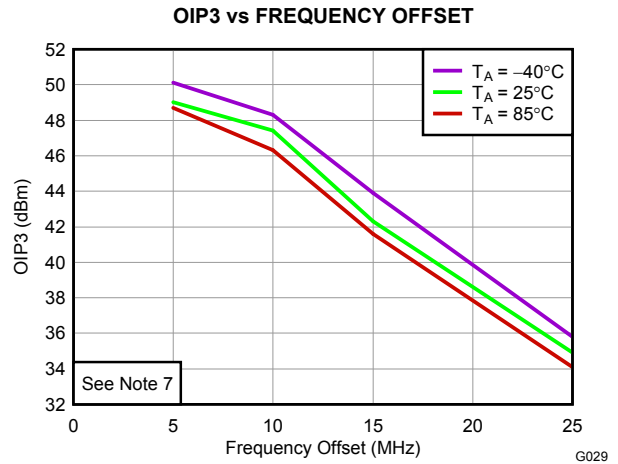

Figure 29.

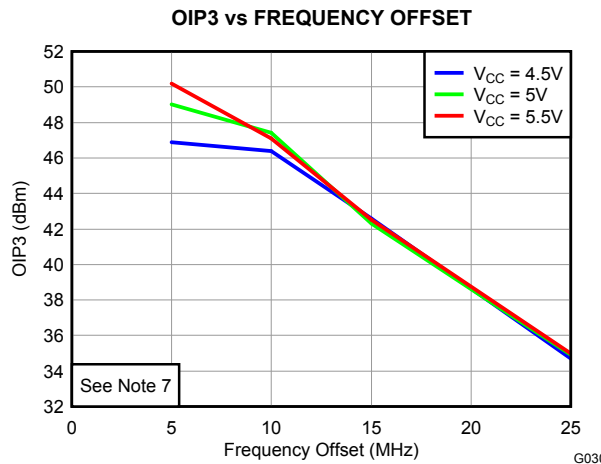

Figure 30.

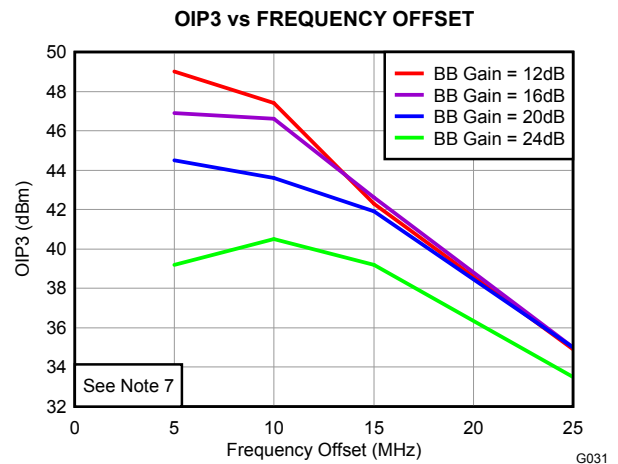

Figure 31.

**TYPICAL CHARACTERISTICS (continued)**

$V_{CC} = 5\text{ V}$ , LO power = 0 dBm,  $T_A = 25^\circ\text{C}$ , balun = Murata LDB212G4005C-001 (unless otherwise noted)

**OIP3 vs FREQUENCY OFFSET**

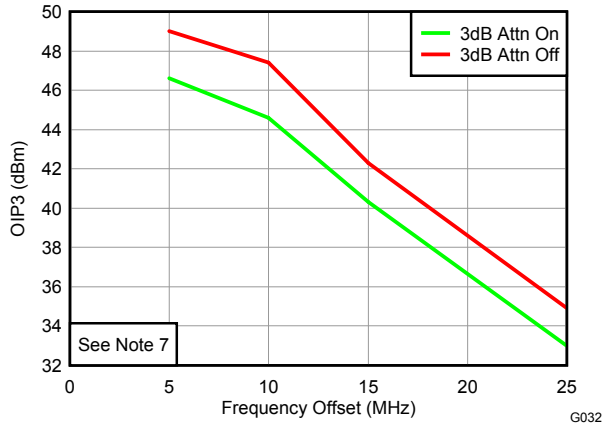

Figure 32.

**NOISE FIGURE vs BB GAIN SETTING**

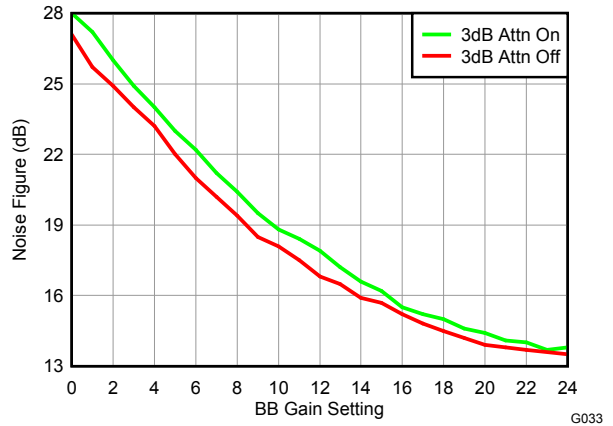

Figure 33.

**GAIN vs BB GAIN SETTING**

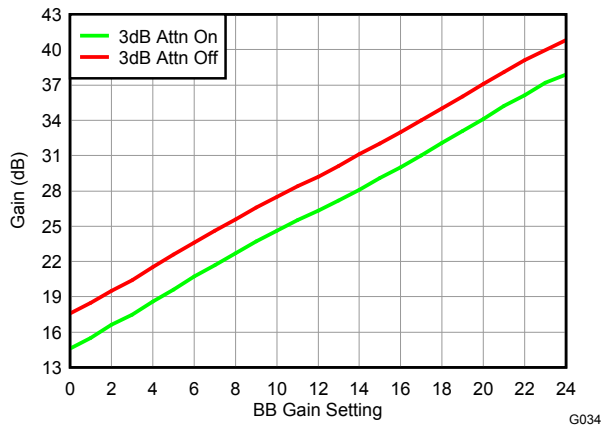

Figure 34.

**GAIN vs FREQUENCY OFFSET**

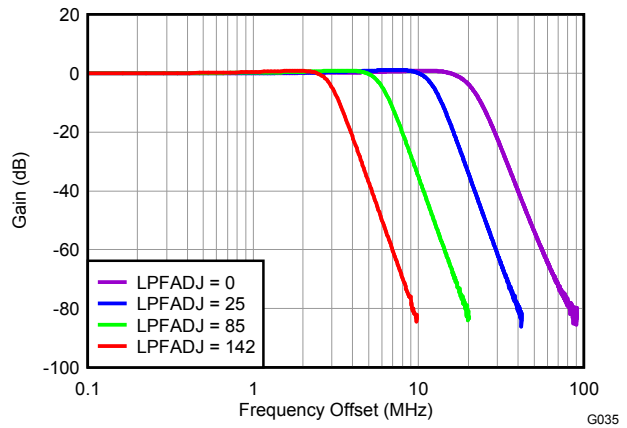

Figure 35.

**GAIN vs FREQUENCY OFFSET**

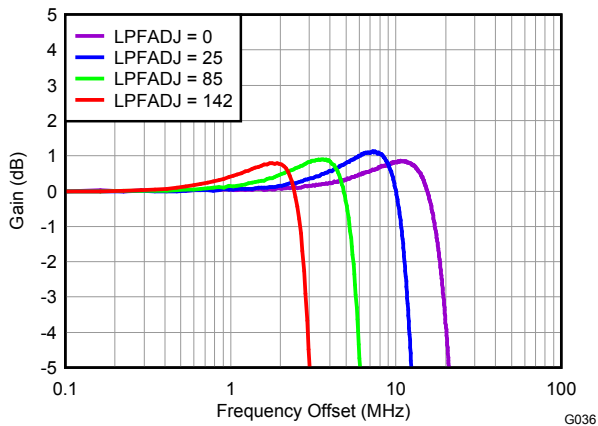

Figure 36.

**GAIN vs FREQUENCY OFFSET**

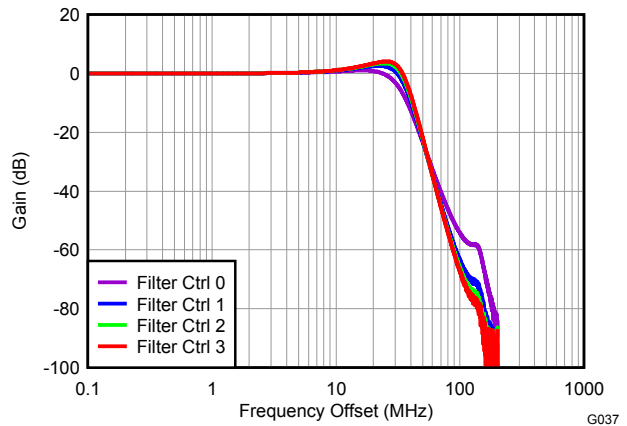

Figure 37. Bypass Mode

**TYPICAL CHARACTERISTICS (continued)**

$V_{CC} = 5\text{ V}$ , LO power = 0 dBm,  $T_A = 25^\circ\text{C}$ , balun = Murata LDB212G4005C-001 (unless otherwise noted)

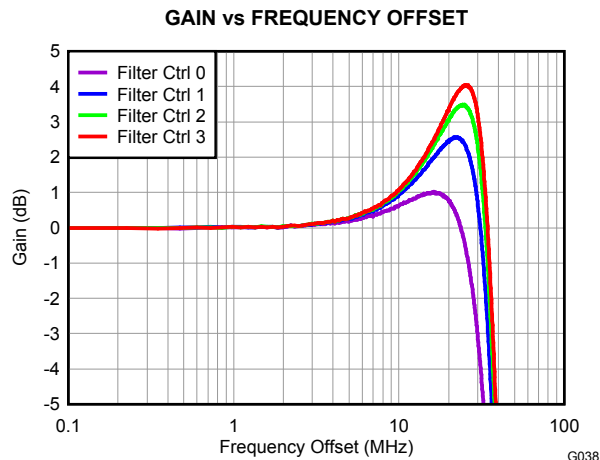

Figure 38. Bypass Mode

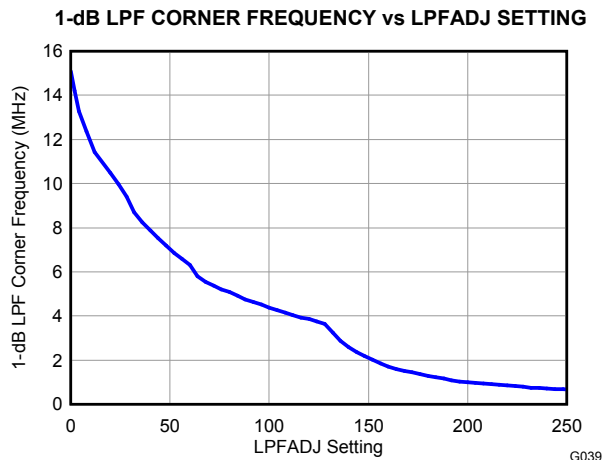

Figure 39.

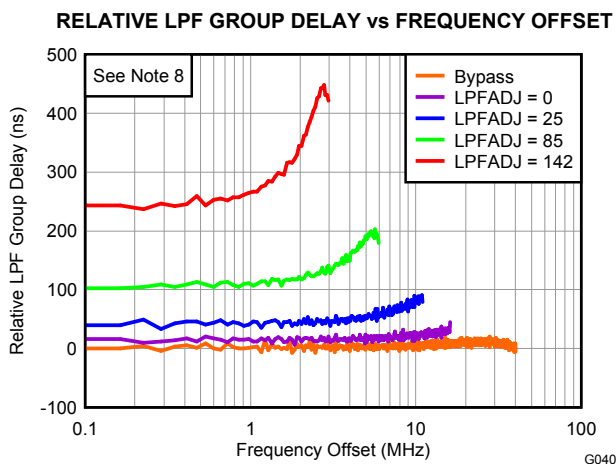

Figure 40.

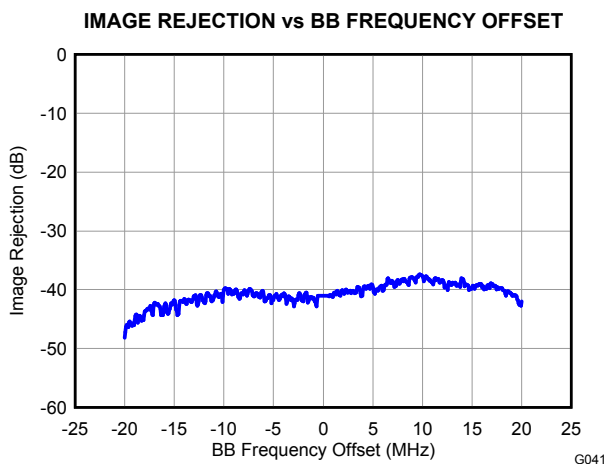

Figure 41.

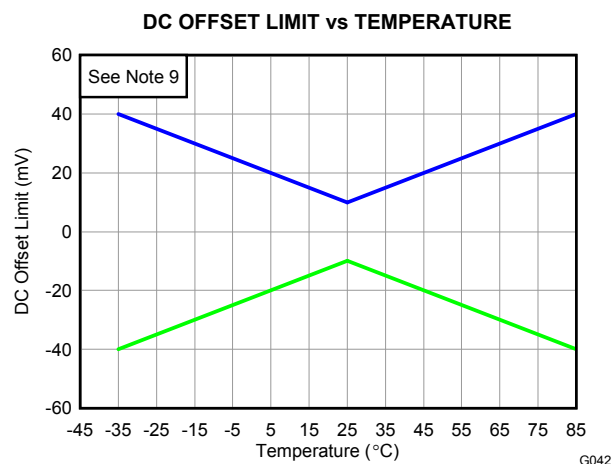

Figure 42.

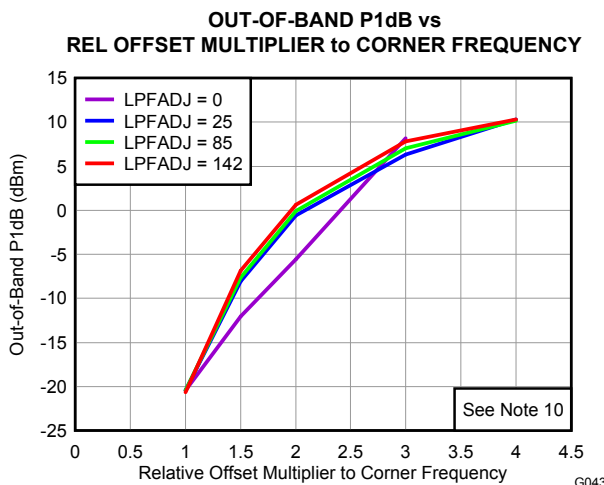

Figure 43.

## REGISTER INFORMATION

### SERIAL INTERFACE PROGRAMMING REGISTERS DEFINITION

The TRF371125 features a three-wire serial programming interface (SPI) that controls an internal 32-bit shift register. There are three signals that must be applied: CLOCK (pin 48), serial DATA (pin 47), and STROBE (pin 46). DATA (DB0–DB31) is loaded LSB-first and is read on the rising edge of CLOCK. STROBE is asynchronous to CLOCK, and at its rising edge the data in the shift register is loaded into the selected internal register. The first two bits (DB0–DB1) are the address to select the available internal registers.

### READBACK Mode

The TRF371125 implements the capability to read back the content of the serial programming interface registers. In addition, it is possible to read back the status of the internal DAC registers that are automatically set after an auto dc-offset calibration. Each readback is composed by two phases: writing followed by the actual reading of the internal data (see timing diagram in Figure 44).

During the writing phase, a command is sent to the TRF371125 to set it in readback mode and to specify which register is to be read. In the proper reading phase, at each rising clock edge, the internal data is transferred into the READBACK pin and can be read at the following falling edge (LSB first). The first clock after LE goes high (end of writing cycle) is idle, and the following 32 clock pulses transfer the internal register content to the READBACK pin.

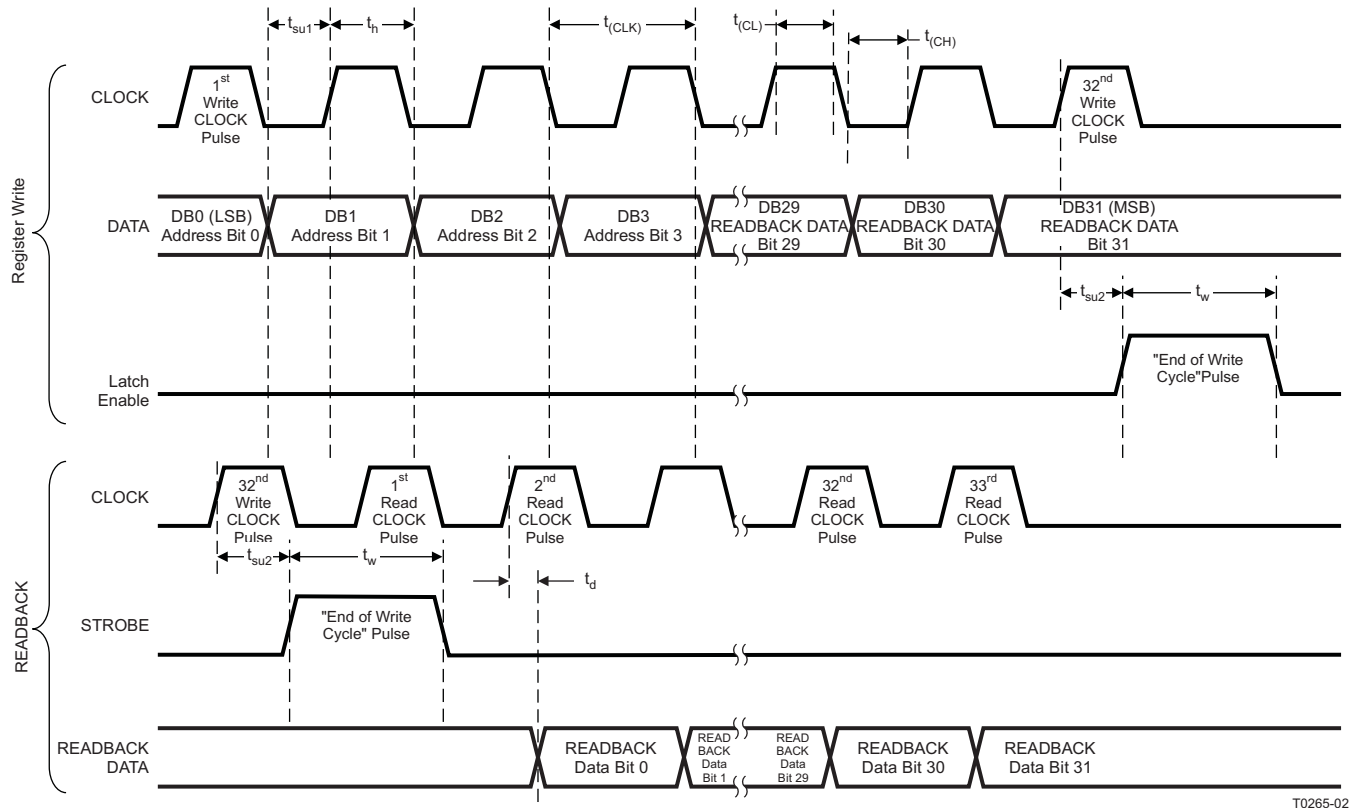

T0265-02

Figure 44. Serial Programming Timing Diagram

**Table 1. Register Summary<sup>(1)</sup>**

Bit #	Reg 1	Reg 2	Bit #	Reg 3	Reg 5	Bit #	Reg 0			
Bit0	Register address	Register address	Bit0	Register address	Register address	Bit0	Register address			
Bit1			Bit1			Bit1				
Bit2			Bit2			Bit2				
Bit3	SPI bank addr	SPI bank addr	Bit3	SPI bank addr	SPI bank addr	Bit3	SPI bank addr			
Bit4			Bit4			Bit4				
Bit5	PWD RF	En auto-cal	Bit5	ILoadA	Mix GM trim	Bit5	ID			
Bit6	NU	IDAC for dc offset	Bit6		Bit6	Bit6				
Bit7	PWD buf		Bit7		Bit7	Mix LO trim	Bit7	NU		
Bit8	P		Bit8		Bit8	LO trim	Bit8			
Bit9	NU		Bit9		Bit9		Bit9		Bit9	
Bit10	PWD DC OFF DIG		Bit10		Bit10	Mix buf trim	Bit10			
Bit11	NU		Bit11		Bit11		Bit11		Bit11	
Bit12	BB gain		QDAC for dc offset		Bit12	ILoadB	Filtr trim		Bit12	DC offset Q DAC
Bit13					Bit13				Bit13	
Bit14		Bit14			Out buf trim		Bit14		Bit14	
Bit15		Bit15		Bit15			Bit15			
Bit16		Bit16		Bit16	Bit16					
Bit17		LPFADJ		IDet	Bit17		QLoadA	NU	Bit17	
Bit18	Bit18		Bit18							
Bit19	Bit19		Bit19							
Bit20	Bit20		Bit20							
Bit21	Bit21		Bit21							
Bit22	Bit22		Bit22							
Bit23	DC detector bandwidth	Cal sel	Bit23	QLoadB	NU	Bit23	DC offset I DAC			
Bit24			Bit24			Bit24				
Bit25			Bit25			Bit25				
Bit26			Bit26			Bit26				
Bit27	Fast gain	CLK div ratio	Bit27	Bypass	NU	Bit27	DC offset I DAC			
Bit28	Gain sel		Bit28			Bit28				
Bit29	Osc test	Cal clk sel	Bit29	Filtr ctrl	NU	Bit29	DC offset I DAC			
Bit30	NU		Bit30			Bit30				
Bit31	En 3dB attn		Bit31			Bit31				

(1) Register 4 is not used.

**Table 2. Register 1 Device Setup**

REGISTER 1	NAME	RESET VALUE	WORKING DESCRIPTION
Bit0	ADDR<0>	1	Register address
Bit1	ADDR<1>	0	
Bit2	ADDR<2>	0	
Bit3	ADDR<3>	1	SPI bank address
Bit4	ADDR<4>	0	
Bit5	PWD_MIX	0	Mixer power down (Off = 1)
Bit6	NU	0	Not used
Bit7	PWD_BUF	1	Mixer out test buffer power down (Off = 1)
Bit8	PWD_FILTER	0	Baseband filter power down (Off = 1)
Bit9	NU	0	Not used
Bit10	PWD_DC_OFF_DIG	1	DC offset calibration power down (Off = 1)

**Table 2. Register 1 Device Setup (continued)**

REGISTER 1	NAME	RESET VALUE	WORKING DESCRIPTION
Bit11	NU	1	Not used
Bit12	BBGAIN_0	1	Baseband gain setting. Default = 15. Range is from 0 (minimum gain setting) to 24 (maximum gain setting). See the <a href="#">Application Information</a> section for more information on gain setting and fast gain control options.
Bit13	BBGAIN_1	1	
Bit14	BBGAIN_2	1	
Bit15	BBGAIN_3	1	
Bit16	BBGAIN_4	0	
Bit17	LPFADJ_0	0	Sets programmable low-pass filter corner frequency. Range = 255 (lowest corner frequency) to 0 (highest corner frequency). Default value is 128.
Bit18	LPFADJ_1	0	
Bit19	LPFADJ_2	0	
Bit20	LPFADJ_3	0	
Bit21	LPFADJ_4	0	
Bit22	LPFADJ_5	0	
Bit23	LPFADJ_6	0	
Bit24	LPFADJ_7	1	
Bit25	EN_FLT_B0	0	Selects dc offset detector filter bandwidth.
Bit26	EN_FLT_B1	0	Setting {00, 01, 11} = {10 MHz, 10 kHz, 1 kHz}
Bit27	EN_FASTGAIN	0	Enable external fast-gain control
Bit28	GAIN_SEL	0	Fast-gain control multiplier bit (x2 = 1)
Bit29	OSC_TEST	0	Enables osc out on readback pin if = 1
Bit30	NU	0	Not used
Bit31	EN 3dB Attn	0	Enables output 3-dB attenuator

**EN\_FLT\_B0/1:** These bits control the bandwidth of the detector used to measure the dc offset during the automatic calibration. There is an RC filter in front of the detector that can be fully bypassed. EN\_FLT\_B0 controls the resistor (bypass = 1), while EN\_FLT\_B1 controls the capacitor (bypass = 1). The typical 3-dB cutoff frequencies of the detector bandwidth are summarized in the following table (see the [Application Information](#) section for more detail on the dc offset calibration and the detector bandwidth).

EN_FLT_B1	EN_FLT_B0	TYPICAL 3-dB CUTOFF FREQ	NOTES
x	0	10 MHz	Maximum bandwidth, bypass R, C
0	1	10 kHz	Enable R
1	1	1 kHz	Minimum bandwidth, enable R, C

**Table 3. Register 2 Device Setup**

REGISTER 2	NAME	RESET VALUE	WORKING DESCRIPTION
Bit0	ADDR<0>	0	Register address
Bit1	ADDR<1>	1	
Bit2	ADDR<2>	0	
Bit3	ADDR<3>	1	SPI bank address
Bit4	ADDR<4>	0	
Bit5	EN_AUTOCAL	0	Enable autocal when = 1; reset to 0 when done.
Bit6	IDAC_BIT0	0	I-DAC bits to be set during manual dc offset cal
Bit7	IDAC_BIT1	0	
Bit8	IDAC_BIT2	0	
Bit9	IDAC_BIT3	0	
Bit10	IDAC_BIT4	0	
Bit11	IDAC_BIT5	0	
Bit12	IDAC_BIT6	0	
Bit13	IDAC_BIT7	1	



**Table 3. Register 2 Device Setup (continued)**

REGISTER 2	NAME	RESET VALUE	WORKING DESCRIPTION
Bit14	QDAC_BIT0	0	Q-DAC bits to be set during manual dc offset cal
Bit15	QDAC_BIT1	0	
Bit16	QDAC_BIT2	0	
Bit17	QDAC_BIT3	0	
Bit18	QDAC_BIT4	0	
Bit19	QDAC_BIT5	0	
Bit20	QDAC_BIT6	0	
Bit21	QDAC_BIT7	1	
Bit22	IDET_B0	1	Set reference current for digital calibration; Settings {00 to 11} = {50 $\mu$ A to 200 $\mu$ A}. Setting 00 = highest resolution.
Bit23	IDET_B1	1	
Bit24	CAL_SEL	1	DC offset calibration select. 0 = manual cal; 1 = autocal.
Bit25	Clk_div_ratio<0>	0	Clk divider ratio. Setting {000 to 111} = {1, 8, 16, 128, 256, 1024, 2048, 16684}. A higher div ratio (slower clk) improves cal accuracy and reduces speed.
Bit26	Clk_div_ratio<1>	0	
Bit27	Clk_div_ratio<2>	0	
Bit28	Cal_clk_sel	1	Select internal oscillator when 1, SPI clk when 0
Bit29	Osc_trim<0>	1	Internal oscillator frequency trimming; Setting {000} = ~300 kHz; Setting {111} = ~1.8 MHz. Nominal setting {110} = ~900 kHz.
Bit30	Osc_trim<1>	1	
Bit31	Osc_trim<2>	0	

**Table 4. Register 3 Device Setup**

REGISTER 3	NAME	RESET VALUE	WORKING DESCRIPTION
Bit0	ADDR<0>	1	Register address
Bit1	ADDR<1>	1	
Bit2	ADDR<2>	0	
Bit3	ADDR<3>	1	SPI bank address
Bit4	ADDR<4>	0	
Bit5	ILOAD_a<0>	0	I mixer offset side A
Bit6	ILOAD_a<1>	0	
Bit7	ILOAD_a<2>	0	
Bit8	ILOAD_a<3>	0	
Bit9	ILOAD_a<4>	0	
Bit10	ILOAD_a<5>	0	
Bit11	ILOAD_b<0>	0	I mixer offset side B
Bit12	ILOAD_b<1>	0	
Bit13	ILOAD_b<2>	0	
Bit14	ILOAD_b<3>	0	
Bit15	ILOAD_b<4>	0	
Bit16	ILOAD_b<5>	0	
Bit17	QLOAD_a<0>	0	Q mixer offset side A
Bit18	QLOAD_a<1>	0	
Bit19	QLOAD_a<2>	0	
Bit20	QLOAD_a<3>	0	
Bit21	QLOAD_a<4>	0	
Bit22	QLOAD_a<5>	0	

**Table 4. Register 3 Device Setup (continued)**

REGISTER 3	NAME	RESET VALUE	WORKING DESCRIPTION
Bit23	QLOAD_b<0>	0	Q mixer offset side B
Bit24	QLOAD_b<1>	0	
Bit25	QLOAD_b<2>	0	
Bit26	QLOAD_b<3>	0	
Bit27	QLOAD_b<4>	0	
Bit28	QLOAD_b<5>	0	
Bit29	Bypass	0	Engage filter bypass
Bit30	Fltr Ctrl_b<0>	1	Used to adjust for filter peaking response; set to 0 in bypass mode, 1 otherwise
Bit31	Fltr Ctrl_b<1>	0	

**I/Q Mixer Load A/B:** these bits adjust the load on the mixer output. All values should be 0. No modification is necessary.

**Register 4:** No programming required for Register 4

**Table 5. Register 5 Device Setup**

REGISTER 5	NAME	RESET VALUE	WORKING DESCRIPTION
Bit0	ADDR<0>	1	Register address
Bit1	ADDR<1>	0	
Bit2	ADDR<2>	1	
Bit3	ADDR<3>	1	
Bit4	ADDR<4>	0	SPI bank address
Bit5	MIX_GM_TRIM<0>	1	Mixer gm current trim
Bit6	MIX_GM_TRIM<1>	0	
Bit7	MIX_LO_TRIM<0>	1	Mixer switch core VCM trim
Bit8	MIX_LO_TRIM<1>	0	
Bit9	LO_TRIM<0>	1	LO buffers current trim
Bit10	LO_TRIM<1>	0	
Bit11	MIX_BUFF_TRIM<0>	1	Mixer output buffer current trim
Bit12	MIX_BUFF_TRIM<1>	0	
Bit13	FLTR_TRIM<0>	1	Filter current trim
Bit14	FLTR_TRIM<1>	0	
Bit15	OUT_BUFF_TRIM<0>	1	Filter output buffer current trim
Bit16	OUT_BUFF_TRIM<1>	0	
Bit17	NU	0	Not used
Bit18		0	
Bit19		0	
Bit20		0	
Bit21		0	
Bit22		0	
Bit23		0	
Bit24		0	
Bit25		0	
Bit26		0	
Bit27		0	
Bit28		0	
Bit29		0	
Bit30		0	
Bit31		0	

**Trims:** the trim values allow for minor bias adjustments of internal stages. Generally it is recommended to leave all trim values at the default value of 1. Linearity performance improvement over a small band of frequencies is possible by selective adjustment of the trim values. Optimized intercept point within the band 2.5 GHz to 2.7 GHz is achieved by setting trim values Mix GM trim, Mix LO Trim, LO Trim, Mix Buff Trim, Filter Trim, Out Buff Trim to: 2, 3, 0, 1, 2, 1, respectively.

### Readback (Write Command)

0	0	0	1	0	Zero Fill										
Bit0	Bit1	Bit2	Bit3	Bit4	Bit5	Bit6	Bit7	Bit8	Bit9	Bit10	Bit11	Bit12	Bit13	Bit14	Bit15
Zero fill												Register address		1	
Bit16	Bit17	Bit18	Bit19	Bit20	Bit21	Bit22	Bit23	Bit24	Bit25	Bit26	Bit27	Bit28	Bit29	Bit30	Bit31

### Reg 0: DAC/Device ID Readback

Register Address			SPI Bank Addr		ID		NU								
Bit0	Bit1	Bit2	Bit3	Bit4	Bit5	Bit6	Bit7	Bit8	Bit9	Bit10	Bit11	Bit12	Bit13	Bit14	Bit15
DC offset Q DAC							DC offset I DAC								
Bit16	Bit17	Bit18	Bit19	Bit20	Bit21	Bit22	Bit23	Bit24	Bit25	Bit26	Bit27	Bit28	Bit29	Bit30	Bit31

**Table 6. Register 0 Device Setup (Read-Only)**

READBACK REGISTER	NAME	RESET VALUE	WORKING DESCRIPTION
Bit0	ADDR<0>	0	Select SPI reg 1 to 5
Bit1	ADDR<1>	0	
Bit2	ADDR<2>	0	
Bit3	ADDR<3>	1	
Bit4	ADDR<4>	0	
Bit5	ID<0>	1	Version ID: 01 = -25
Bit6	ID<1>	0	
Bit7	NU	0	Not used
Bit8		0	
Bit9		0	
Bit10		0	
Bit11		0	
Bit12		0	
Bit13		0	
Bit14		0	
Bit15		0	
Bit16		DC_OFFSET_Q<0>	
Bit17	DC_OFFSET_Q<1>	0	
Bit18	DC_OFFSET_Q<2>	0	
Bit19	DC_OFFSET_Q<3>	0	
Bit20	DC_OFFSET_Q<4>	0	
Bit21	DC_OFFSET_Q<5>	0	
Bit22	DC_OFFSET_Q<6>	0	
Bit23	DC_OFFSET_Q<7>	1	

**Table 6. Register 0 Device Setup (Read-Only) (continued)**

READBACK REGISTER	NAME	RESET VALUE	WORKING DESCRIPTION
Bit24	DC_OFFSET_I<0>	0	DC offset DAC I register
Bit25	DC_OFFSET_I<1>	0	
Bit26	DC_OFFSET_I<2>	0	
Bit27	DC_OFFSET_I<3>	0	
Bit28	DC_OFFSET_I<4>	0	
Bit29	DC_OFFSET_I<5>	0	
Bit30	DC_OFFSET_I<6>	0	
Bit31	DC_OFFSET_I<7>	1	

## APPLICATION INFORMATION

### Gain Control

The TRF371125 integrates a baseband programmable-gain amplifier (PGA) that provides 24 dB of gain range with 1-dB steps. The PGA gain is controlled through SPI by a 5-bit word (register 1 bits<12,16>). Alternatively, the PGA can be programmed by a combination of 5 bits programmed through the SPI and 3 parallel external bits (pins Gain\_B2, Gain\_B1, Gain\_B0). The external bits are used to reduce the PGA setting quickly without having to reprogram the SPI registers. The fast gain control multiplier bit (register 1, bit 28) sets the step size of each bit to either 1 dB or 2 dB. This allows a fast gain reduction of 0 dB to 7 dB in 1-dB steps or 0 dB to 14 dB in 2-dB steps.

The PGA gain control word (BBgain<0,4>) can be programmed to a setting between 0 and 24. This word is the SPI programmed gain (register 1 bits<12,16>) minus the parallel external 3 bits as shown in Figure 45. Note that the PGA gain setting rails at 0 and does not go any lower. Typical applications set the nominal PGA gain setting to 17 and use the fast-gain control bits to protect the analog-to-digital converter in the event of a strong input jammer signal.

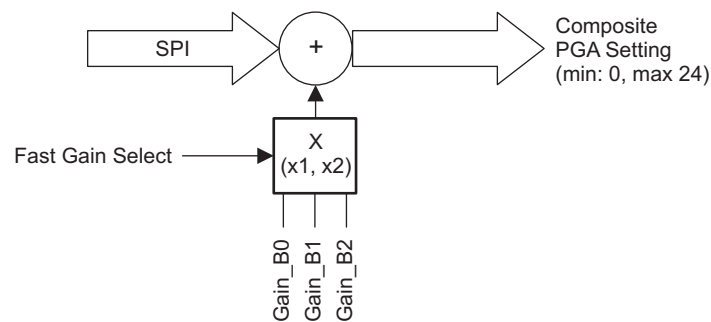

B0386-01

Figure 45. PGA Gain Control Word

For example, if a PGA gain setting of 19 is desired, then the SPI can be programmed directly to a value of 19. Alternatively, the SPI gain register can be programmed to 24 and the parallel external bits set to 101 (binary) corresponding to 5-dB reduction.

### Automated DC Offset Calibration

The TRF371125 provides an automatic calibration procedure for adjusting the dc offset in the baseband I/Q paths. The internal calibration requires a clock in order to function. The TRF371125 can use the internal relaxation oscillator or the external SPI clock. Using the internal oscillator is the preferred method, which is selected by setting the Cal\_Sel\_Clk (register 2, bit 28) to 1. The internal oscillator frequency is set through the Osc\_Trim bits (register 2, bits <29,31>). The frequency of the oscillator is detailed in Table 7; however, it is expected the actual frequency of operation can vary plus or minus 35% due to process variations. The oscillator frequency can be monitored on the READBACK pin when the Osc\_Test register (Register 1, bit 29) is set to 1.

Table 7. Internal Oscillator Frequency Control

Osc_Trim<2>	Osc_Trim<1>	Osc_Trim<0>	FREQUENCY
0	0	0	300 kHz
0	0	1	500 kHz
0	1	0	700 kHz
0	1	1	900 kHz
1	0	0	1.1 MHz
1	0	1	1.3 MHz
1	1	0	1.5 MHz
1	1	1	1.8 MHz

The default setting of these registers corresponds to a 900-kHz oscillator frequency. This is sufficient for autocalibration; modification is not required except for faster calibration convergence.

The output full-scale range of the internal dc offset correction DACs is programmable (IDET\_B<0,1, register 2 bit<22,23>). The range is shown in [Table 8](#).

**Table 8. DC Offset Correction DAC Programmable Range**

I(Q) Det_B0	I(Q) Det_B1	Full Scale
0	0	50 $\mu$ A
0	1	100 $\mu$ A
1	0	150 $\mu$ A
1	1	200 $\mu$ A

The I- and Q-channel output maximum dc offset correction range can be calculated by multiplying the values in the table by the baseband PGA gain. The LSB of the digital correction is dependent on the programmed maximum correction range. For optimum resolution and best correction, the dc offset DAC range should be set to 50  $\mu$ A with the PGA gain set for the nominal condition. The dc offset correction DAC output is affected by a change in the PGA gain, but if the initial calibration yields optimum results, then the adjustment of the PGA gain during normal operation does not significantly impair the dc offset balance. For example, if the optimized calibration yields a dc offset balance of 2 mV at a gain setting of 17, then the dc offset maintains less than 10 mV balance as the gain is adjusted  $\pm 7$  dB.

The dc offset correction DACs are programmed from the internal registers when the AUTO\_CAL bit (register 2, bit 24) is set to 1. At start-up, the internal registers are loaded at half scale corresponding to a decimal value of 128. The auto-cal is initiated by toggling the EN\_AUTO\_CAL bit (register 2, bit 5) to 1. When the calibration is over, this bit is automatically reset to 0. During calibration, the RF local oscillator must be applied. The dc offset DAC state is stored in the internal registers and maintained as long as the power supply is kept on or until a new calibration is started.

The required clock speed for the optimum calibration is determined by the internal detector behavior (integration bandwidth, gain, sensitivity). The input bandwidth of the detector can be adjusted by changing the cutoff frequency of the RC low-pass filter in front of the detector (register 1, bits 25–26). EN\_FLT\_B0 controls the resistor (bypass = 1) and EN\_FLT\_B1 controls the capacitor (bypass = 1). The typical 3-dB cutoff frequencies of the detector bandwidth are summarized in [Table 9](#). The speed of the clock can be slowed down by selecting a clock divider ratio (register 2, bits 25–27).

**Table 9. Detector Bandwidth Settings**

EN_FLT_B1	EN_FLT_B0	TYPICAL 3-dB CUTOFF FREQUENCY	NOTES
X	0	10 MHz	Maximum bandwidth, bypass R, C
0	1	10 kHz	Enable R
1	1	1 kHz	Minimum bandwidth, enable R, C

The detector has more averaging time with a slower clock; hence, it is desirable to slow down the clock speed for a given condition to achieve optimum results. For example, if there is no RF present on the RF input port, the detection filter can be left wide (10 MHz) and the clock divider can be left at div-by-128. The autocalibration yields a dc offset balance between the differential baseband output ports (I and Q) that is less than 15 mV. Some minor improvement may be obtained by increasing the averaging of the detector by increasing the clock divider up to 256 or 1024.

On the other hand, if there is a modulated RF signal present at the input port, it is desirable to reduce the detector bandwidth to filter out most of the modulated signal. The detector bandwidth can be set to a 1-kHz corner frequency. With the modulated signal present and with the detection bandwidth reduced, additional averaging is required to get the optimum results. A clock divider setting of 1024 will yield optimum results.

Of course, an increase in the averaging is possible by increasing the clock divider at the expense of longer converging time. The convergence time can be calculated by the following:

$$\tau_c = \frac{(\text{Auto\_Cal\_Clk\_Cycles}) \times (\text{Clk\_Divider})}{\text{Osc\_Freq}} \quad (1)$$

The dc offset calibration converges in approximately nine cycles. For the case with a clock divider of 1024 and with the nominal oscillator frequency of 900 kHz, the convergence time is:

$$\tau_c = \frac{(9) \times (1024)}{900 \text{ kHz}} = 10.24 \text{ ms} \quad (2)$$

### Alternate Method for Adjusting DC Offset

The internal registers controlling the internal dc current DAC are accessible through the SPI, providing a user-programmable method for implementing the dc offset calibration. To employ this option the CAL\_SEL bit must be set to 0. During this calibration, an external instrument monitors the output dc offset between the I/Q differential outputs and programs the internal registers (IDAC\_BIT<0,7> and QDAC\_BIT<0,7> bits) to cancel the dc offset.

## PCB Layout Guidelines

The TRF371125 device is fitted with a ground slug on the back of the package that must be soldered to the PCB ground with adequate ground vias to ensure a good thermal and electrical connection. The recommended via pattern and ground pad dimensions are shown in [Figure 46](#). The recommended via diameter is 8 mils (0.2 mm). The ground pins of the device can be directly tied to the ground slug pad for a low-inductance path to ground. Additional ground vias may be added if space allows. The no-connect (NC) pins can also be tied to the ground plane.

Decoupling capacitors at each of the supply pins is recommended. The high-frequency decoupling capacitors for the RF mixers (VCCMIX) should be placed close to their respective pins. The value of the capacitor should be chosen to provide a low-impedance RF path to ground at the frequency of operation. Typically, this value is around 10 pF or lower. The other decoupling capacitors at the other supply pins should be kept as close to their respective pins as possible.

The device exhibits symmetry with respect to the quadrature output paths. It is recommended that the PCB layout maintain that symmetry in order to ensure the quadrature balance of the device is not impaired. The I/Q output traces should be routed as differential pairs and their lengths all kept equal to each other. Decoupling capacitors for the supply pins should be kept symmetrical where possible. The RF differential input lines related to the RF input and the LO input should also be routed as differential lines with their respective lengths kept equal. If an RF balun is used to convert a single-ended input to a differential input, then the RF balun should be placed close to the device. Implement the RF balun layout per the manufacturer's guidelines to provide best gain and phase balance to the differential outputs. On the RF traces, maintain proper trace widths to keep the characteristic impedance of the RF traces at a nominal 50  $\Omega$ .

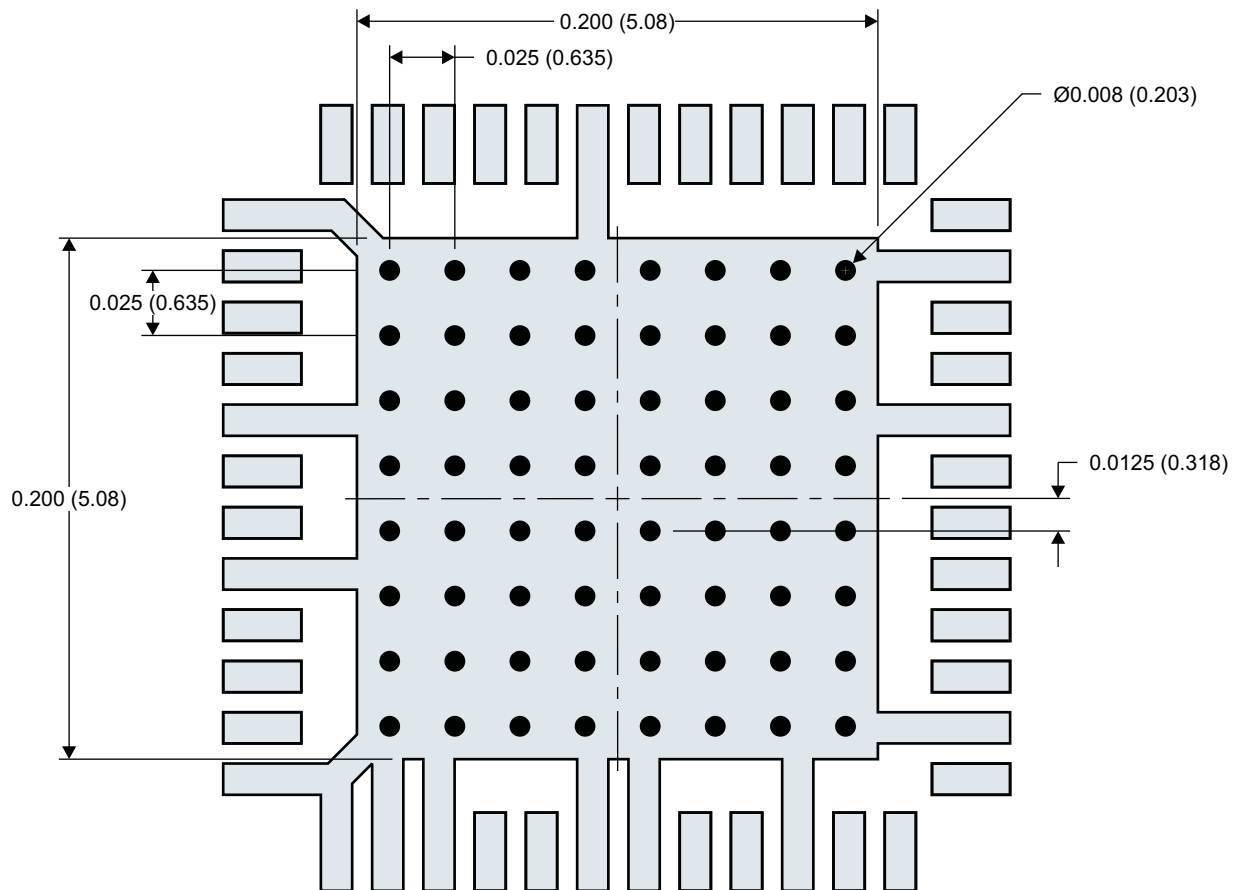

Note: Dimensions are in inches (mm)

M0177-01

**Figure 46. PCB Layout Guidelines**



### Application Schematic

The typical application schematic is shown in Figure 47. The RF bypass capacitors and coupling capacitors on the supply pins should be adjusted to provide the best high-frequency bypass based on the frequency of operation.

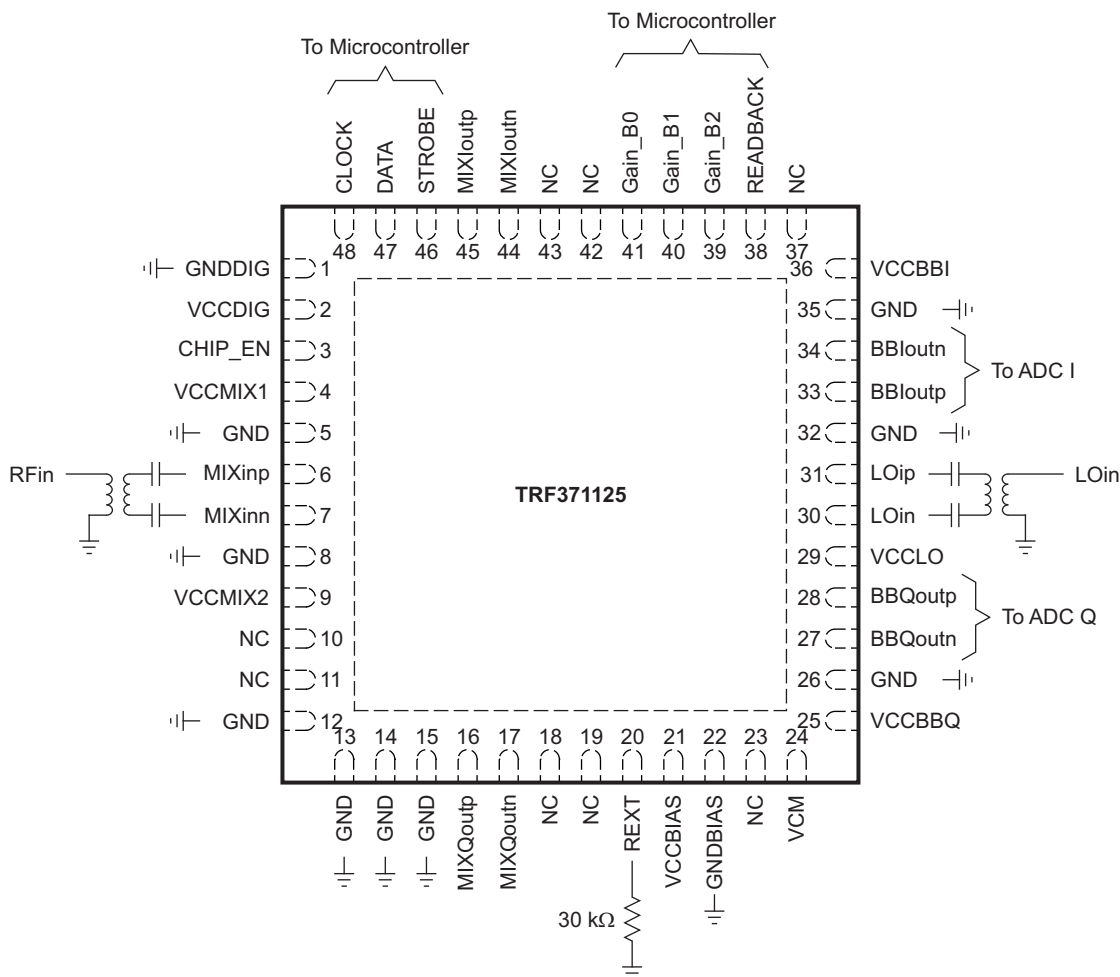

Figure 47. TRF371125 Application Schematic

The RF input port and the RF LO port require differential input paths. Single-ended RF inputs to these ports can be converted with an RF balun that is centered at the band of interest. Linearity performance of the TRF371125 is dependent on the amplitude and phase balance of the RF balun; hence, care should be taken with the selection of the balun device and with the RF layout of the device. The recommended RF balun devices are listed in Table 10.

Table 10. RF Balun Devices

MANUFACTURER	PART NUMBER	FREQUENCY RANGE	UNBALANCE IMPEDANCE	BALANCE IMPEDANCE
Murata	LDB21897M005C-001	897 MHz ±100 MHz	50 Ω	50 Ω
Murata	LDB211G8005C-001	1800 MHz ±100 MHz	50 Ω	50 Ω
Murata	LDB211G9005C-001	1900 MHz ±100 MHz	50 Ω	50 Ω
Murata	LDB212G4005C-001	2.3 GHz to 2.7 GHz	50 Ω	50 Ω
Johanson	3600BL14M050E	3.3 GHz to 3.8 GHz	50 Ω	50 Ω

## Application for a High-Performance RF Receiver Signal Chain

The TRF371125 is the centerpiece component in a high performance direct downconversion receiver. The device is a highly integrated direct downconversion demodulator that requires minimal additional devices to complete the signal chain. A signal chain block diagram example is shown in [Figure 48](#).

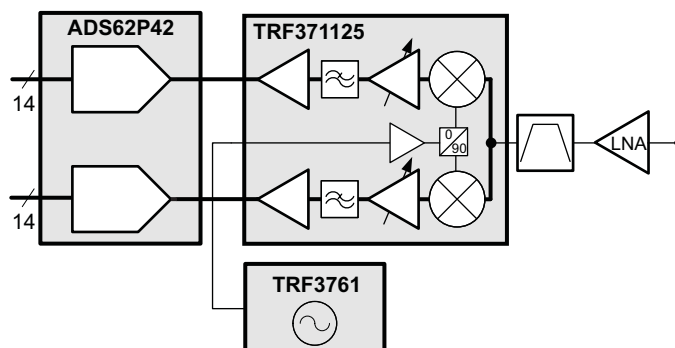

**Figure 48. Block Diagram of Direct Downconvert Receiver**

The lineup requires a low-noise amplifier (LNA) that operates at the frequency of interest with typical 1- to 2-dB noise figure (NF) performance. An RF band-pass filter (BPF) is selected at the frequency band of interest to eliminate unwanted signals and images outside the band from reaching the demodulator. The TRF371125 incorporates the direct downconvert demodulation, baseband filtering, and baseband gain-control functions. An external synthesizer, such as the TRF3761, is used to provide the local oscillator (LO) source to the TRF371125. The differential outputs of the TRF3761 directly mate with LO input of the TRF371125. The quadrature outputs (I/Q) of the TRF371125 directly drive the input to the analog-to-digital converter (ADC). A dual ADC like the ADS62P42 14-bit 65-MSPS ADC mates perfectly with the differential I/Q output of the TRF371125. The baseband output pins (pins 27, 28, 33, 34) can be connected directly to the corresponding input pins of typical ADCs. The positive and negative terminal connections between the TRF371125 and the ADC can be swapped to facilitate a clean routing layout. The swapped connection can be reversed by flipping the signals in the digital domain, if desired. In addition, the common-mode output voltage generated by the ADC is fed directly into the common-mode port (pin 24) to ensure the optimum dynamic range of the ADC is maintained.



## EVALUATION TOOLS

An evaluation module is available to test the TRF371125 performance. The TRF371125EVM can be configured with different baluns to enable operation in various frequency bands. The TRF371125EVM is available for purchase through the Texas Instruments web site at [www.ti.com](http://www.ti.com).

## REVISION HISTORY

<b>Changes from Revision A (March, 2010) to Revision B</b>	<b>Page</b>
• Corrected y-axis value in <a href="#">Figure 29</a> .....	27
• Corrected y-axis value in <a href="#">Figure 30</a> .....	27
• Corrected y-axis value in <a href="#">Figure 31</a> .....	27
• Corrected y-axis value in <a href="#">Figure 32</a> .....	27
<b>Changes from Original (January, 2010) to Revision A</b>	<b>Page</b>
• Corrected product name discussed throughout document .....	1
• Added <a href="#">Evaluation Tools</a> .....	42

**PACKAGING INFORMATION**

Orderable Device	Status (1)	Package Type	Package Drawing	Pins	Package Qty	Eco Plan (2)	Lead finish/ Ball material (6)	MSL Peak Temp (3)	Op Temp (°C)	Device Marking (4/5)	Samples
TRF371125IRGZR	ACTIVE	VQFN	RGZ	48	2500	RoHS & Green	NIPDAUAG	Level-2-260C-1 YEAR	-40 to 85	TRF 371125IRGZ	
TRF371125IRGZT	ACTIVE	VQFN	RGZ	48	250	RoHS & Green	NIPDAUAG	Level-2-260C-1 YEAR	-40 to 85	TRF 371125IRGZ	

(1) The marketing status values are defined as follows:

**ACTIVE:** Product device recommended for new designs.

**LIFEBUY:** TI has announced that the device will be discontinued, and a lifetime-buy period is in effect.

**NRND:** Not recommended for new designs. Device is in production to support existing customers, but TI does not recommend using this part in a new design.

**PREVIEW:** Device has been announced but is not in production. Samples may or may not be available.

**OBSOLETE:** TI has discontinued the production of the device.

(2) **RoHS:** TI defines "RoHS" to mean semiconductor products that are compliant with the current EU RoHS requirements for all 10 RoHS substances, including the requirement that RoHS substance do not exceed 0.1% by weight in homogeneous materials. Where designed to be soldered at high temperatures, "RoHS" products are suitable for use in specified lead-free processes. TI may reference these types of products as "Pb-Free".

**RoHS Exempt:** TI defines "RoHS Exempt" to mean products that contain lead but are compliant with EU RoHS pursuant to a specific EU RoHS exemption.

**Green:** TI defines "Green" to mean the content of Chlorine (Cl) and Bromine (Br) based flame retardants meet JS709B low halogen requirements of <=1000ppm threshold. Antimony trioxide based flame retardants must also meet the <=1000ppm threshold requirement.

(3) MSL, Peak Temp. - The Moisture Sensitivity Level rating according to the JEDEC industry standard classifications, and peak solder temperature.

(4) There may be additional marking, which relates to the logo, the lot trace code information, or the environmental category on the device.

(5) Multiple Device Markings will be inside parentheses. Only one Device Marking contained in parentheses and separated by a "~" will appear on a device. If a line is indented then it is a continuation of the previous line and the two combined represent the entire Device Marking for that device.

(6) Lead finish/Ball material - Orderable Devices may have multiple material finish options. Finish options are separated by a vertical ruled line. Lead finish/Ball material values may wrap to two lines if the finish value exceeds the maximum column width.

**Important Information and Disclaimer:**The information provided on this page represents TI's knowledge and belief as of the date that it is provided. TI bases its knowledge and belief on information provided by third parties, and makes no representation or warranty as to the accuracy of such information. Efforts are underway to better integrate information from third parties. TI has taken and continues to take reasonable steps to provide representative and accurate information but may not have conducted destructive testing or chemical analysis on incoming materials and chemicals. TI and TI suppliers consider certain information to be proprietary, and thus CAS numbers and other limited information may not be available for release.

In no event shall TI's liability arising out of such information exceed the total purchase price of the TI part(s) at issue in this document sold by TI to Customer on an annual basis.



**TAPE AND REEL INFORMATION**

**QUADRANT ASSIGNMENTS FOR PIN 1 ORIENTATION IN TAPE**

\*All dimensions are nominal

Device	Package Type	Package Drawing	Pins	SPQ	Reel Diameter (mm)	Reel Width W1 (mm)	A0 (mm)	B0 (mm)	K0 (mm)	P1 (mm)	W (mm)	Pin1 Quadrant
TRF371125IRGZR	VQFN	RGZ	48	2500	330.0	16.4	7.3	7.3	1.5	12.0	16.0	Q2
TRF371125IRGZT	VQFN	RGZ	48	250	180.0	16.4	7.3	7.3	1.5	12.0	16.0	Q2

TAPE AND REEL BOX DIMENSIONS



\*All dimensions are nominal

Device	Package Type	Package Drawing	Pins	SPQ	Length (mm)	Width (mm)	Height (mm)
TRF371125IRGZR	VQFN	RGZ	48	2500	350.0	350.0	43.0
TRF371125IRGZT	VQFN	RGZ	48	250	213.0	191.0	55.0

## GENERIC PACKAGE VIEW

**RGZ 48**

**VQFN - 1 mm max height**

7 x 7, 0.5 mm pitch

PLASTIC QUADFLAT PACK- NO LEAD

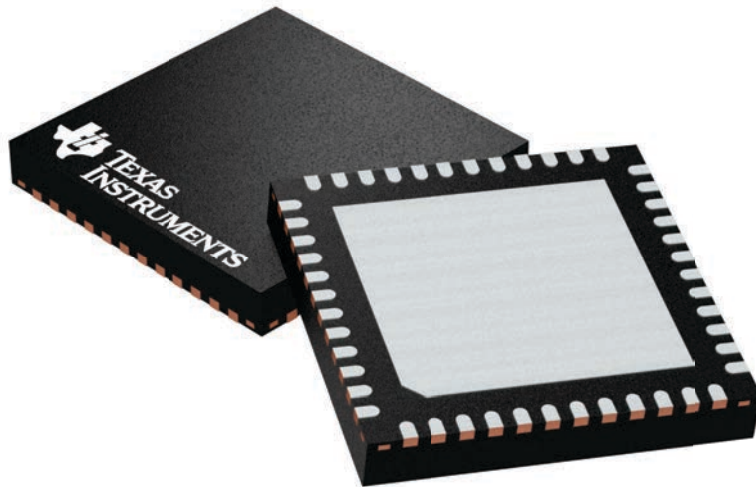

Images above are just a representation of the package family, actual package may vary.  
Refer to the product data sheet for package details.

4224671/A



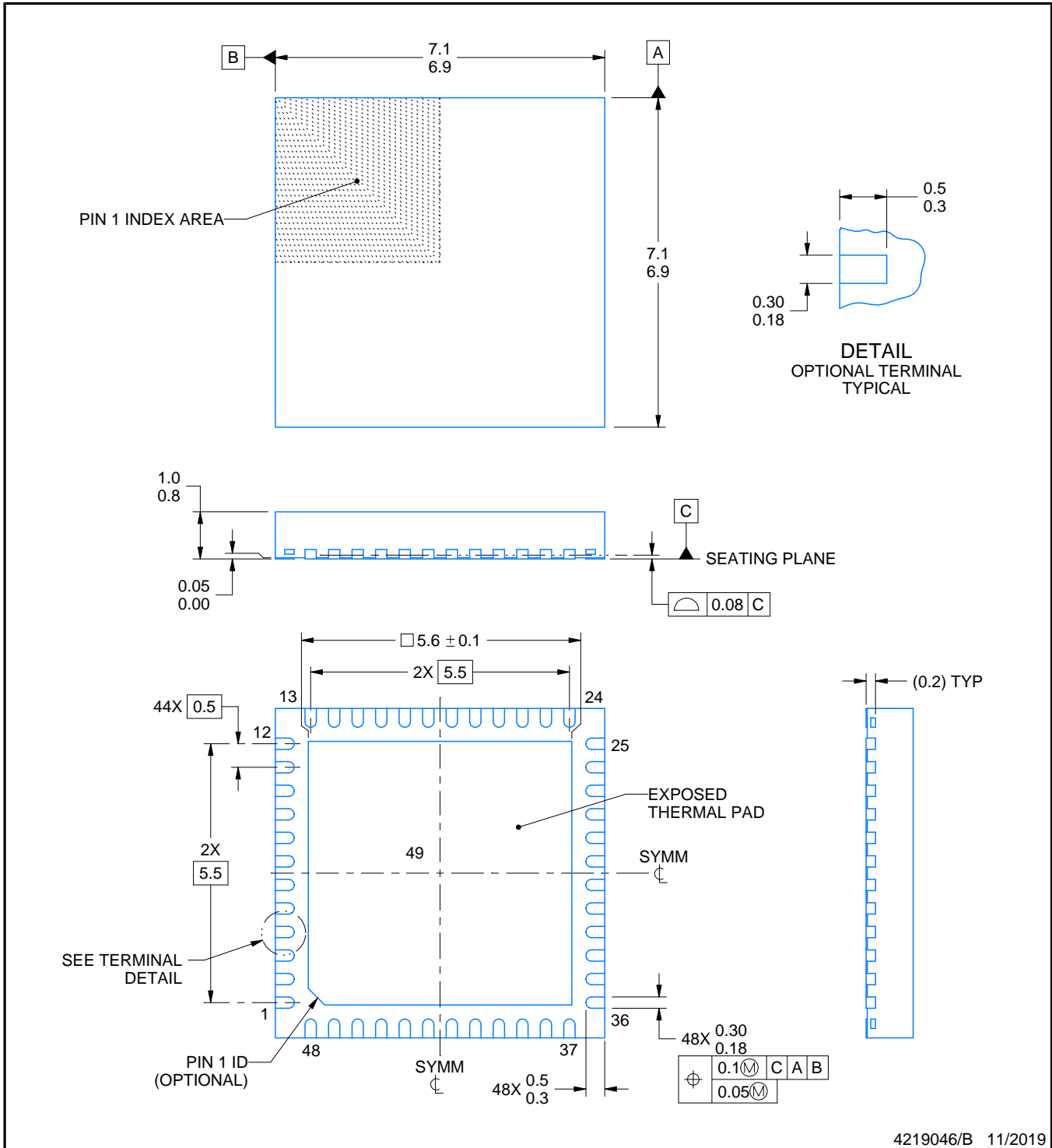
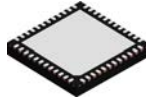

4219046/B 11/2019

NOTES:

1. All linear dimensions are in millimeters. Any dimensions in parenthesis are for reference only. Dimensioning and tolerancing per ASME Y14.5M.
2. This drawing is subject to change without notice.
3. The package thermal pad must be soldered to the printed circuit board for thermal and mechanical performance.

# EXAMPLE BOARD LAYOUT

**RGZ0048D**

**VQFN - 1 mm max height**

PLASTIC QUAD FLATPACK - NO LEAD

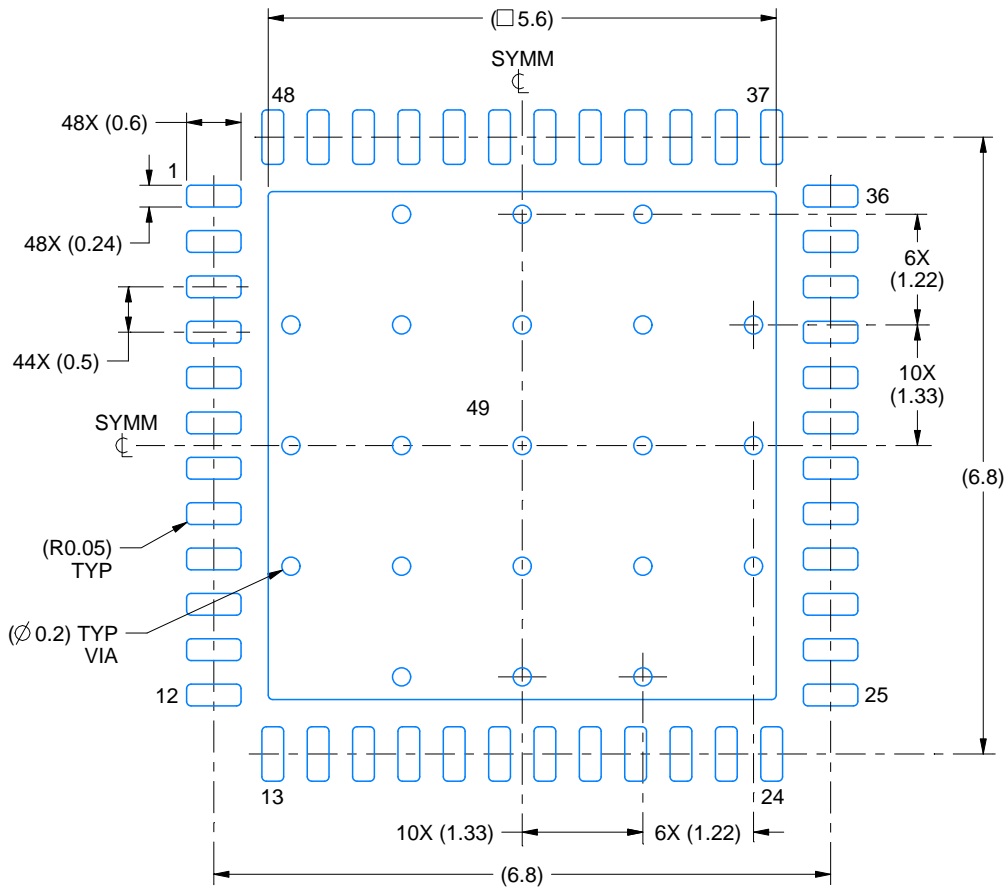

**LAND PATTERN EXAMPLE**  
EXPOSED METAL SHOWN  
SCALE:12X

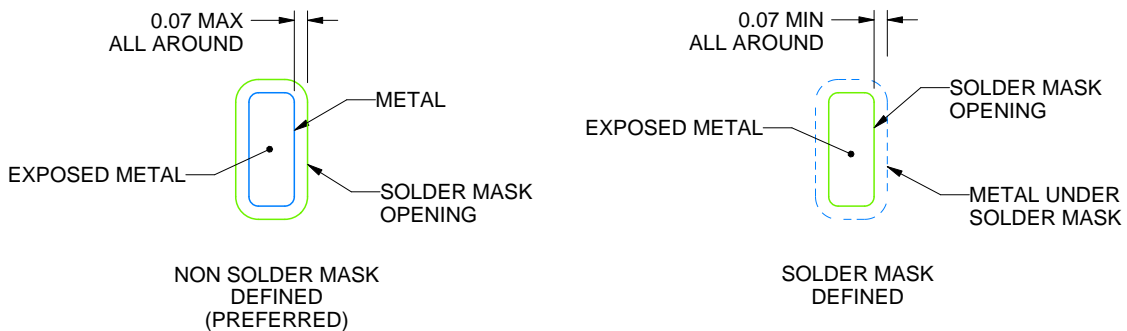

**SOLDER MASK DETAILS**

4219046/B 11/2019

NOTES: (continued)

4. This package is designed to be soldered to a thermal pad on the board. For more information, see Texas Instruments literature number SLUA271 ([www.ti.com/lit/sluea271](http://www.ti.com/lit/sluea271)).
5. Vias are optional depending on application, refer to device data sheet. If any vias are implemented, refer to their locations shown on this view. It is recommended that vias under paste be filled, plugged or tented.

# EXAMPLE STENCIL DESIGN

RGZ0048D

VQFN - 1 mm max height

PLASTIC QUAD FLATPACK - NO LEAD

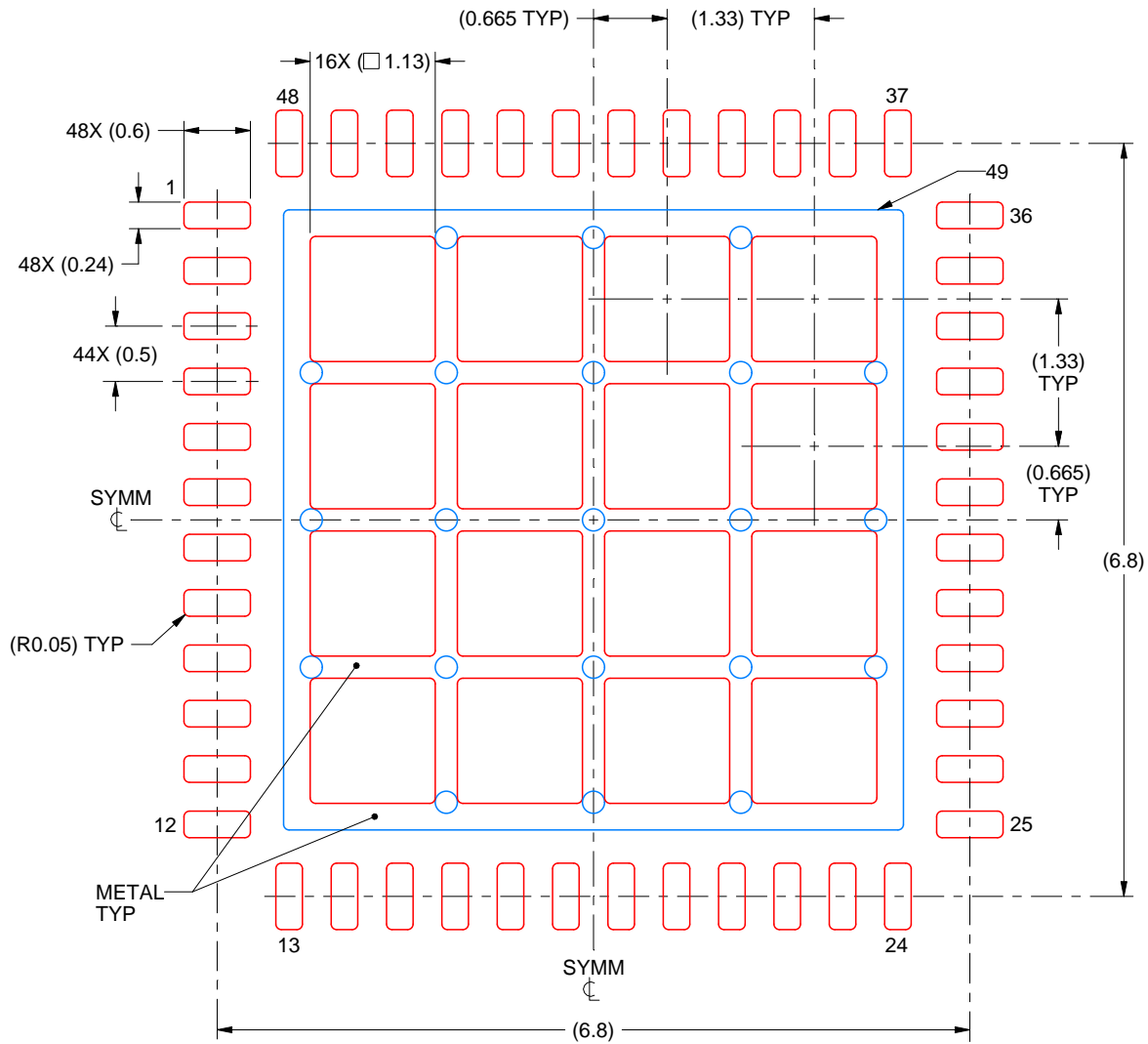

**SOLDER PASTE EXAMPLE**  
 BASED ON 0.125 mm THICK STENCIL

EXPOSED PAD 49  
 66% PRINTED SOLDER COVERAGE BY AREA UNDER PACKAGE  
 SCALE:15X

4219046/B 11/2019

NOTES: (continued)

- 6. Laser cutting apertures with trapezoidal walls and rounded corners may offer better paste release. IPC-7525 may have alternate design recommendations.

## IMPORTANT NOTICE AND DISCLAIMER

TI PROVIDES TECHNICAL AND RELIABILITY DATA (INCLUDING DATA SHEETS), DESIGN RESOURCES (INCLUDING REFERENCE DESIGNS), APPLICATION OR OTHER DESIGN ADVICE, WEB TOOLS, SAFETY INFORMATION, AND OTHER RESOURCES "AS IS" AND WITH ALL FAULTS, AND DISCLAIMS ALL WARRANTIES, EXPRESS AND IMPLIED, INCLUDING WITHOUT LIMITATION ANY IMPLIED WARRANTIES OF MERCHANTABILITY, FITNESS FOR A PARTICULAR PURPOSE OR NON-INFRINGEMENT OF THIRD PARTY INTELLECTUAL PROPERTY RIGHTS.

These resources are intended for skilled developers designing with TI products. You are solely responsible for (1) selecting the appropriate TI products for your application, (2) designing, validating and testing your application, and (3) ensuring your application meets applicable standards, and any other safety, security, regulatory or other requirements.

These resources are subject to change without notice. TI grants you permission to use these resources only for development of an application that uses the TI products described in the resource. Other reproduction and display of these resources is prohibited. No license is granted to any other TI intellectual property right or to any third party intellectual property right. TI disclaims responsibility for, and you will fully indemnify TI and its representatives against, any claims, damages, costs, losses, and liabilities arising out of your use of these resources.

TI's products are provided subject to [TI's Terms of Sale](#) or other applicable terms available either on [ti.com](http://ti.com) or provided in conjunction with such TI products. TI's provision of these resources does not expand or otherwise alter TI's applicable warranties or warranty disclaimers for TI products.

TI objects to and rejects any additional or different terms you may have proposed.

Mailing Address: Texas Instruments, Post Office Box 655303, Dallas, Texas 75265  
Copyright © 2022, Texas Instruments Incorporated