

TRS-73180G / TRS-73180CG / TRS-73180TG / TRS-73180CTG / TRS-73180FG / TRS-73180CFG
3.3V / 1550 nm / 1.25 Gbps RoHS Compliant Optical Single-Mode Transceiver

FEATURES

- | Duplex SC Single Mode Transceiver: TRS-73180G
- | Duplex ST Single Mode Transceiver: TRS-73180TG
- | Duplex FC Single Mode Transceiver: TRS-73180FG
- | Compliant with IEEE-802.3z Gigabit Ethernet
- | 1550 nm DFB LD Transmitter
- | High Sensitivity APD Receiver
- | **38 dB Power Budget At Least**
- | **Distance up to 160 km**
- | 0 to 70°C Operating
- | Industry Standard 1 x 9 Footprint
- | Single +3.3V Power Supply
- | **RoHS Compliant**
- | LVPECL Signal Detect Output: TRS-73180G
- | LVTTL Signal Detect Output: TRS-73180CG
- | Wave Solderable and Aqueous Washable
- | Class 1 Laser International Safety Standard IEC 60825 Compliant

DESCRIPTION

The TRS-73180G series single mode transceivers is low power, high performance module for bi-directional serial optical data communications such Gigabit Ethernet and Fibre Channel. This module is designed for single mode fiber and operates at a nominal wavelength of 1550 nm. A guaranteed minimum optical link budget of 38 dB is offered which can correspond to a link distance of over 180 km (assuming worst case fiber loss of 0.20 dB/km). The transmitter section uses a multiple quantum well laser and is a class 1 laser compliant according to International Safety Standard IEC-60825. The receiver section uses an integrated InGaAs Avalanche photodetector preamplifier (IDP) mounted in an optical header and a limiting post-amplifier IC. A PECL logic interface simplifies interface to external circuitry.

LASER SAFETY

This single mode transceiver is a Class 1 laser product. It complies with IEC 60825 and FDA 21 CFR 1040.10 and 1040.11. The transceiver must be operated within the specified temperature and voltage limits. The optical ports of the module shall be terminated with an optical connector or with a dust plug.

APPLICATIONS

- | Switch to Switch Interface
- | High Speed Interface for File Servers
- | High Performance Desktops

ORDER INFORMATION

P/No.	Bit Rate (Mb/s)	IEEE 802.3z	Distance (km)	Wavelength (nm)	Voltage (V)	Package	Temp. (°C)	TX Power (dBm)	RX Sens. (dBm)	RoHS Compliant
TRS-73180G	1250	EZX	180	1550 DFB	3.3	1X9 SC	0 to 70	6 to 3	-35	Yes

Note: TRS-XXXXXFG for FC duplex transceiver, TRS-XXXXXTG for ST duplex transceiver, TRS-XXXXX-EMG for SC duplex transceiver with extended EMI shielding, TRS-XXXXXCXG for transceiver with TTL signal detection output.

Absolute Maximum Ratings					
Parameter	Symbol	Min	Max	Units	Notes
Storage Temperature	Tstg	-40	85	°C	
Operating Temperature	Topr	0	70	°C	
Soldering Temperature	---		260	°C	10 seconds on leads only
Power Supply Voltage	Vcc	0	4.5	V	
Input Voltage	---	GND	Vcc	V	
Output Current	Iout	0	30	mA	

Recommended Operating Conditions					
Parameter	Symbol	Min	Typ	Max	Units
Power Supply Voltage	Vcc	3.13	3.3	3.47	V
Operating Temperature	Topr	0		70	°C
Data Rate			1250	1300	Mb/s
Power Supply Current	Icc			280	mA

Transmitter Specifications (0°C < Topr < 70°C, 3.13V < Vcc < 3.47V)

Parameter	Symbol	Min	Typ	Max	Units	Notes
Optical						
Optical Transmit Power	Po	3	---	6	dBm	1
Output Center Wavelength	λ	1500	1550	1580	nm	
Output Spectrum Width	$\Delta\lambda$	---	---	1	nm	-20 dB Width
Side Mode Suppression Ratio	SMSR	30			dB	
Extinction Ratio	ER	9	---	---	dB	
Output Eye	Compliant with IEEE 802.3z					
Optical Rise Time	tr			0.26	ns	20% to 80% Values
Optical Fall Time	tf			0.26	ns	20% to 80% Values
Relative Intensity Noise	RIN			-120	dB/Hz	
Total Jitter	TJ			0.227	ns	2
Electrical						
Data Input Current – Low	IL	-350			μ A	
Data Input Current – High	I _{IH}			350	μ A	
Differential Input Voltage	V _{IH} - V _{IL}	300			mV	
Data Input Voltage – Low	V _{IL} - V _{CC}	-2.0		-1.58	V	3
Data Input Voltage -- High	V _{IH} - V _{CC}	-1.1		-0.74	V	3

- Notes: 1. Output power is power coupled into a 9/125 μ m single mode fiber.
 2. Measured with a 2⁷-1 PRBS.
 3. These inputs are compatible with 10K, 10KH and 100K ECL and LVPECL inputs.

Receiver Specifications (0°C < Topr < 70°C, 3.13 V < Vcc < 3.47V)

Parameter	Symbol	Min	Typ	Max	Units	Notes
Optical						
Sensitivity	---	---	---	-35	dBm	1
Maximum Input Power	P _{in}	-9		---	dBm	
Signal Detect -- Asserted	P _a	---	---	-35	dBm	Transition: low to high
Signal Detect -- Deasserted	P _d	-45	---	---	dBm	Transition: high to low
Signal detect -- Hysteresis		1.0	---		dB	
Wavelength of Operation		1100	---	1600	nm	
Electrical						
Data Output Voltage – Low	V _{OL} - V _{CC}	-2.0		-1.58	V	3
Data Output Voltage – High	V _{OH} - V _{CC}	-1.1		-0.74	V	3
Signal Detect Output Voltage -- Low	V _{OL} - V _{CC}	-2.0		-1.58	V	TRS-73180G
Signal Detect Output Voltage -- High	V _{OH} - V _{CC}	-1.1		-0.74	V	
Signal Detect Output Voltage -- Low	V _{SDL}			0.8	V	TRS-73180CG
Signal Detect Output Voltage -- High	V _{SDH}	2.0			V	

- Notes: 1. Minimum sensitivity and saturation levels at BER=1E-12 for a 2⁷-1 PRBS at ER= 9 dB.
 2. These outputs are compatible with 10K, 10KH and 100K ECL and PECL outputs.

CONNECTION DIAGRAM

Receiver Signal Ground	1 (Rx GND)	○
Receiver Data Out	2 (RD+)	N/C
Receiver Data Out Bar	3 (RD-)	
Signal Detect	4 (SD)	
Receiver Power Supply	5 (Rx Vcc)	TOP VIEW
Transmitter Power Supply	6 (Tx Vcc)	
Transmitter Data In Bar	7 (TD-)	
Transmitter Data In	8 (TD+)	N/C
Transmitter Signal Ground	9 (Tx GND)	○

PIN	Symbol	Notes
1	Rx GND	Directly connect this pin to the receiver ground plane
2	RD+	See recommended circuit schematic
3	RD-	See recommended circuit schematic
4	SD	Active high on this indicates a received optical signal
5	Rx Vcc	+3.3V dc power for the receiver section
6	Tx Vcc	+3.3V dc power for the transmitter section
7	TD-	See recommended circuit schematic
8	TD+	See recommended circuit schematic
9	Tx GND	Directly connect this plan to the transmitter ground plane

RECOMMENDED CIRCUIT SCHEMATIC

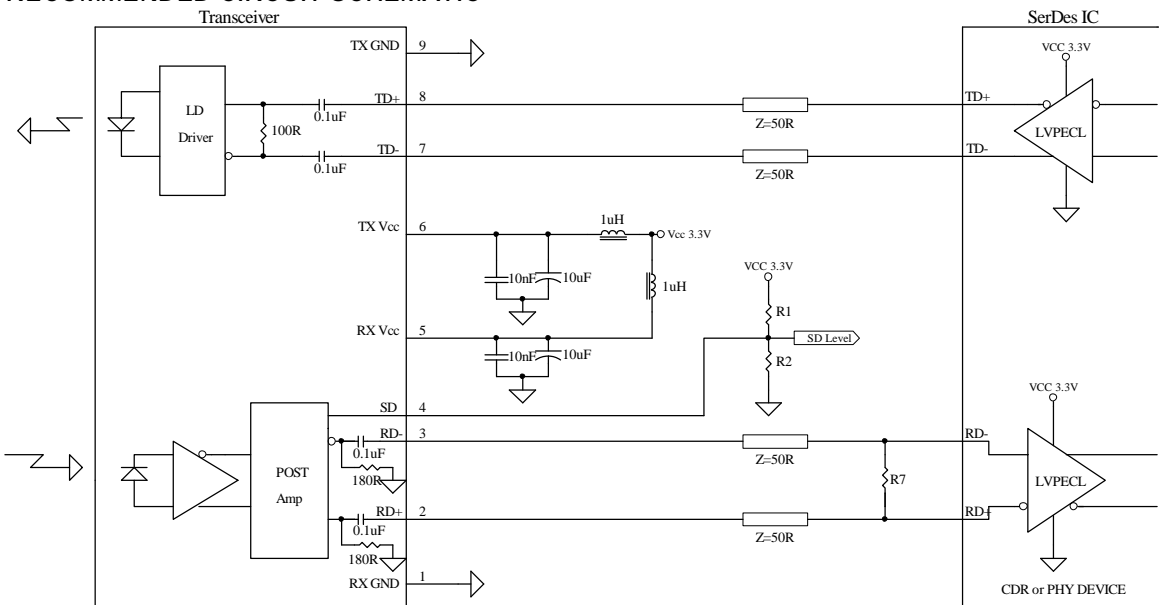

For TTL SD Level, R1=R2=N.C., R7=100 ohm
 For PECL SD Level, R1=130 ohm, R2=82 ohm, R7=100 ohm

The split-load terminations for ECL signals need to be located at the input of devices receiving those ECL signals. The power supply filtering is required for good EMI performance. Use short tracks from the inductor L1/L2 to the module Rx Vcc and Tx Vcc. A GND plane under the module is required for good EMI and sensitivity performance.

PACKAGE DIAGRAM

Units in mm

1) SC Type With Extended Shielding

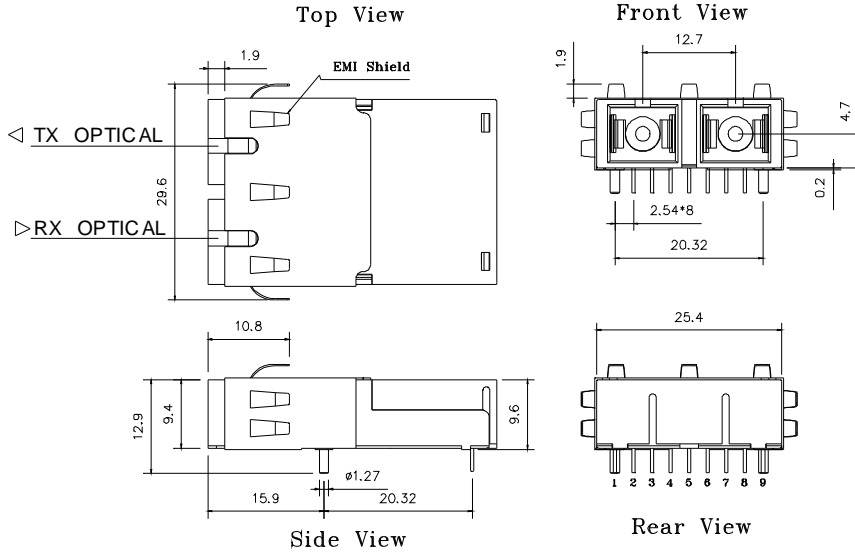

TRS-73180-EMG / TRS-73180C-EMG

2) ST Type

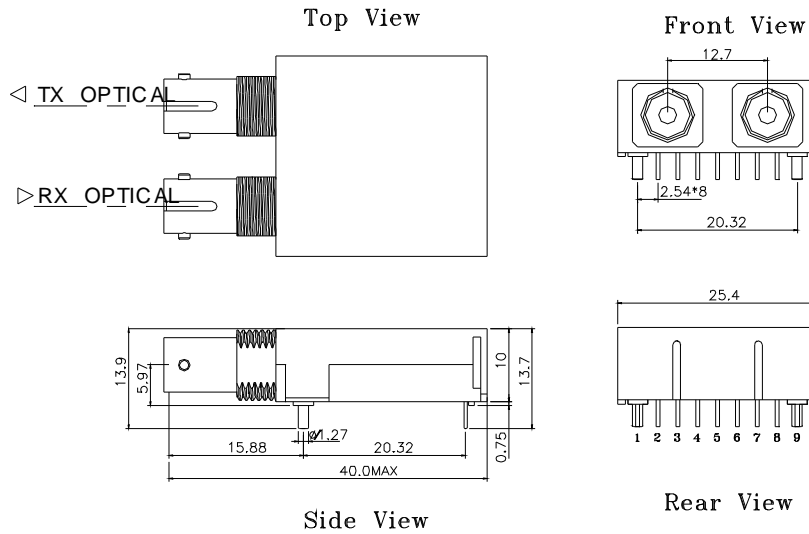

TRS-73180TG / TRS-73180CTG

3) FC Type

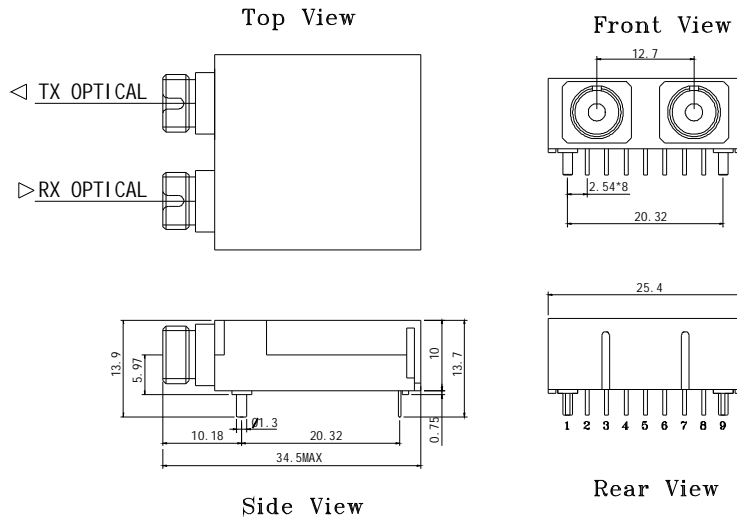

TRS-73180FG / TRS-73180CFG

Note: Specifications subject to change without notice.