

## THE ONLY 0.8V/0.6 $\mu$ A RAIL-TO-RAIL DUAL/QUAD OP AMPS

### FEATURES

- Single 0.65V to 2.5V Operation
- Supply current: 0.6 $\mu$ A per amplifier (typ)
- Offset voltage: 0.5mV (typ)
- Low TCV<sub>OS</sub>: 10 $\mu$ V/ $^{\circ}$ C (typ)
- A<sub>VOL</sub> Driving 100k $\Omega$  Load: 90dB (min)
- Unity Gain Stable
- Rail-to-rail Input and Output
- No Output Phase Reversal
- Packaging: TS1002 – 8-pin MSOP  
TS1004 – 14-pin TSSOP

### APPLICATIONS

- Battery/Solar-Powered Instrumentation
- Portable Gas Monitors
- Low-voltage Signal Processing
- Nanopower Active Filters
- Wireless Remote Sensors
- Battery-powered Industrial Sensors
- Active RFID Readers
- Powerline or Battery Current Sensing
- Handheld/Portable POS Terminals

### DESCRIPTION

The TS1002 and the TS1004 are the industry's first and only dual and quad single-supply, precision CMOS operational amplifiers fully specified to operate at 0.8V while consuming less than 0.6 $\mu$ A supply current per amplifier. Optimized for ultra-long-life battery-powered applications, the TS1002 and the TS1004 join the TS1001 operational amplifier in the "NanoWatt Analog™" high-performance analog integrated circuits portfolio. Both op amps exhibit a typical offset voltage of 0.5mV, a typical input bias current of 25pA, and rail-to-rail input and output stages. The TS1002 and the TS1004 can operate from single-supply voltages from 0.65V to 2.5V.

The TS1002/TS1004's combined features make either an excellent choice in applications where very low supply current and low operating supply voltage translate into very long equipment operating time. Applications include: nanopower active filters, wireless remote sensors, battery and powerline current sensors, portable gas monitors, and handheld/portable POS terminals.

The TS1002 and the TS1004 are fully specified at V<sub>DD</sub> = 0.8V and over the industrial temperature range (-40 $^{\circ}$ C to +85 $^{\circ}$ C). The TS1002 is available in PCB-space saving 8-lead MSOP surface-mount packages. The TS1004 is available in a 14-pin TSSOP package.

### TYPICAL APPLICATION CIRCUIT

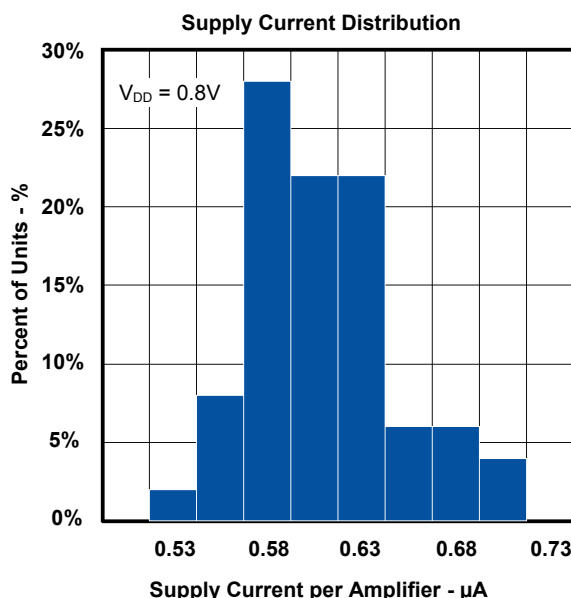
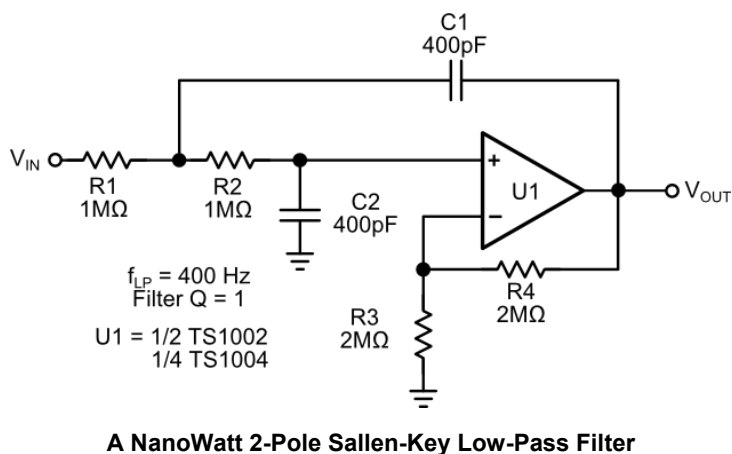

## ABSOLUTE MAXIMUM RATINGS

Total Supply Voltage ( $V_{DD}$  to  $V_{SS}$ ) ..... +2.75 V  
 Voltage Inputs ( $IN+$ ,  $IN-$ ) ..... ( $V_{SS} - 0.3V$ ) to ( $V_{DD} + 0.3V$ )  
 Differential Input Voltage .....  $\pm 2.75$  V  
 Input Current ( $IN+$ ,  $IN-$ ) ..... 20 mA  
 Output Short-Circuit Duration to GND ..... Indefinite  
 Continuous Power Dissipation ( $T_A = +70^\circ C$ )  
     8-Pin MSOP (Derate 7mW/ $^\circ C$  above  $+70^\circ C$ )..... 450 mW  
     14-pin TSSOP (Derate 8.3mW/ $^\circ C$  above  $+70^\circ C$ )  
     ..... 500 mW

Operating Temperature Range .....  $-40^\circ C$  to  $+85^\circ C$   
 Junction Temperature .....  $+150^\circ C$   
 Storage Temperature Range .....  $-65^\circ C$  to  $+150^\circ C$   
 Lead Temperature (soldering, 10s).....  $+300^\circ$

Electrical and thermal stresses beyond those listed under "Absolute Maximum Ratings" may cause permanent damage to the device. These are stress ratings only and functional operation of the device at these or any other condition beyond those indicated in the operational sections of the specifications is not implied. Exposure to any absolute maximum rating conditions for extended periods may affect device reliability and lifetime.

## PACKAGE/ORDERING INFORMATION

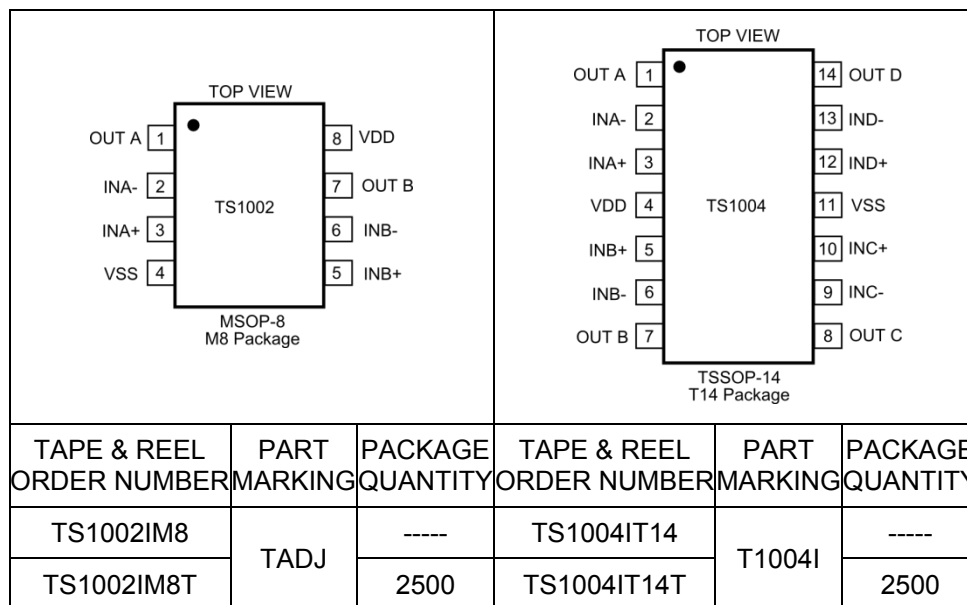

**Lead-free Program:** Silicon Labs supplies only lead-free packaging.

Consult Silicon Labs for products specified with wider operating temperature ranges.

## ELECTRICAL CHARACTERISTICS

$V_{DD} = +0.8V$ ,  $V_{SS} = 0V$ ,  $V_{INCM} = V_{SS}$ ;  $R_L = 100k\Omega$  to  $(V_{DD}-V_{SS})/2$ ;  $T_A = -40^\circ C$  to  $+85^\circ C$ , unless otherwise noted. Typical values are at  $T_A = +25^\circ C$ . See Note 1

Parameters	Symbol	Conditions	Min	Typ	Max	Units
Supply Voltage Range	$V_{DD}-V_{SS}$		0.65	0.8	2.5	V
Supply Current	$I_{SY}$	TS1002; $R_L = \text{Open circuit}$	$T_A = 25^\circ C$	1.2	1.6	$\mu A$
			$-40^\circ C \leq T_A \leq 85^\circ C$		2	
		TS1004; $R_L = \text{Open circuit}$	$T_A = 25^\circ C$	2.4	3.2	$\mu A$
			$-40^\circ C \leq T_A \leq 85^\circ C$		4	
Input Offset Voltage	$V_{OS}$	$V_{IN} = V_{SS}$ or $V_{DD}$		0.5	3	mV
					5	
Input Offset Voltage Drift	$TCV_{OS}$			10		$\mu V/^\circ C$
Input Bias Current	$I_{IN+}, I_{IN-}$	$V_{IN+}, V_{IN-} = (V_{DD} - V_{SS})/2$	$T_A = 25^\circ C$	0.025		nA
			$-40^\circ C \leq T_A \leq 85^\circ C$		20	
Input Offset Current	$I_{OS}$	Specified as $I_{IN+} - I_{IN-}$ $V_{IN+}, V_{IN-} = (V_{DD} - V_{SS})/2$		0.01	2	nA
Input Voltage Range	IVR	Guaranteed by Input Offset Voltage Test	$V_{SS}$		$V_{DD}$	V
Common-Mode Rejection Ratio	CMRR	$0V \leq V_{IN(CM)} \leq 0.4V$	50	74		dB
Power Supply Rejection Ratio	PSRR	$0.65V \leq (V_{DD} - V_{SS}) \leq 2.5V$	50	74		dB
Output Voltage High	$V_{OH}$	Specified as $V_{DD} - V_{OUT}$ , $R_L = 100k\Omega$ to $V_{SS}$	$T_A = 25^\circ C$	1.2	2	mV
			$-40^\circ C \leq T_A \leq 85^\circ C$		2.5	
		Specified as $V_{DD} - V_{OUT}$ , $R_L = 10k\Omega$ to $V_{SS}$	$T_A = 25^\circ C$	10	16	
			$-40^\circ C \leq T_A \leq 85^\circ C$		20	
Output Voltage Low	$V_{OL}$	Specified as $V_{OUT} - V_{SS}$ , $R_L = 100k\Omega$ to $V_{DD}$	$T_A = 25^\circ C$	0.4	0.6	mV
			$-40^\circ C \leq T_A \leq 85^\circ C$		1	
		Specified as $V_{OUT} - V_{SS}$ , $R_L = 10k\Omega$ to $V_{DD}$	$T_A = 25^\circ C$	5	7	
			$-40^\circ C \leq T_A \leq 85^\circ C$		10	
Short-circuit Current	$I_{SC+}$	$V_{OUT} = V_{SS}$	$T_A = 25^\circ C$	0.5	1.5	mA
			$-40^\circ C \leq T_A \leq 85^\circ C$		0.3	
	$I_{SC-}$	$V_{OUT} = V_{DD}$	$T_A = 25^\circ C$	4.5	11	
			$-40^\circ C \leq T_A \leq 85^\circ C$		3	
Open-loop Voltage Gain	$A_{VOL}$	$V_{SS}+50mV \leq V_{OUT} \leq V_{DD}-50mV$	$T_A = 25^\circ C$	90	104	dB
			$-40^\circ C \leq T_A \leq 85^\circ C$		85	
Gain-Bandwidth Product	GBWP	$R_L = 100k\Omega$ to $V_{SS}$ , $C_L = 20pF$		4		kHz
Phase Margin	$\Phi_M$	Unity-gain Crossover, $R_L = 100k\Omega$ to $V_{SS}$ , $C_L = 20pF$		70		degrees
Slew Rate	SR	$R_L = 100k\Omega$ to $V_{SS}$ , $A_{VCL} = +1V/V$		1.5		V/ms
Full-power Bandwidth	FPBW	$FPBW = SR/(\pi \cdot V_{OUT,PP})$ ; $V_{OUT,PP} = 0.7V_{PP}$		680		Hz
Input Voltage Noise Density	$e_n$	$f = 1kHz$		0.6		$\mu V/\sqrt{Hz}$
Input Current Noise Density	$i_n$	$f = 1kHz$		10		$pA/\sqrt{Hz}$

**Note 1:** All specifications are 100% tested at  $T_A = +25^\circ C$ . Specification limits over temperature ( $T_A = T_{MIN}$  to  $T_{MAX}$ ) are guaranteed by device characterization, not production tested.

## TYPICAL PERFORMANCE CHARACTERISTICS

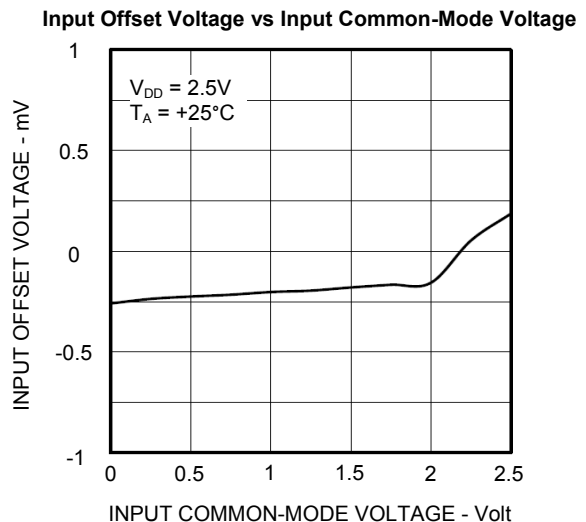
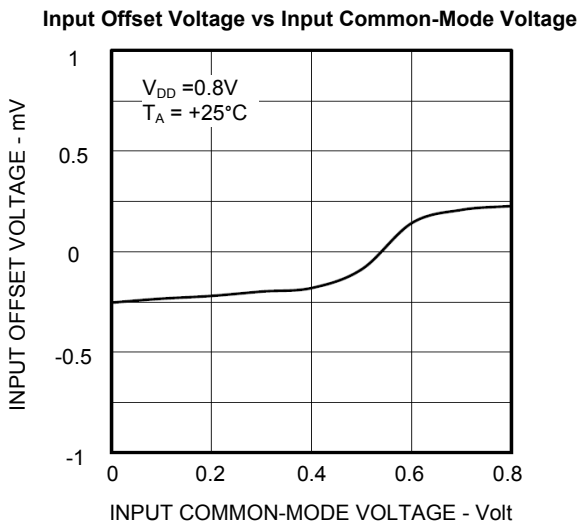
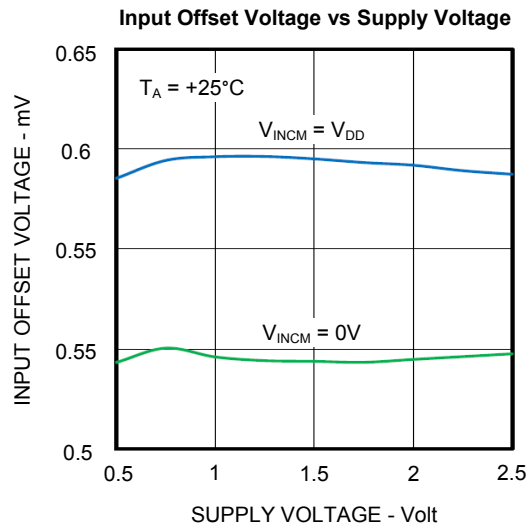
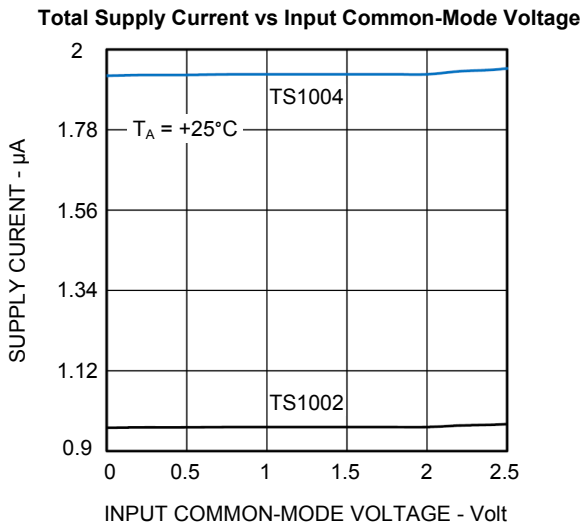
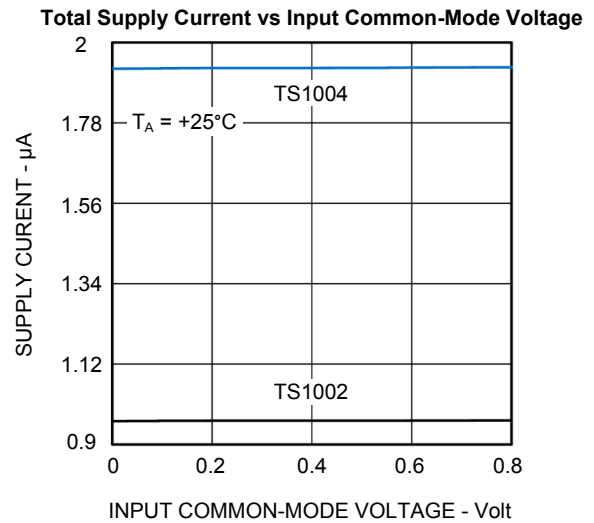
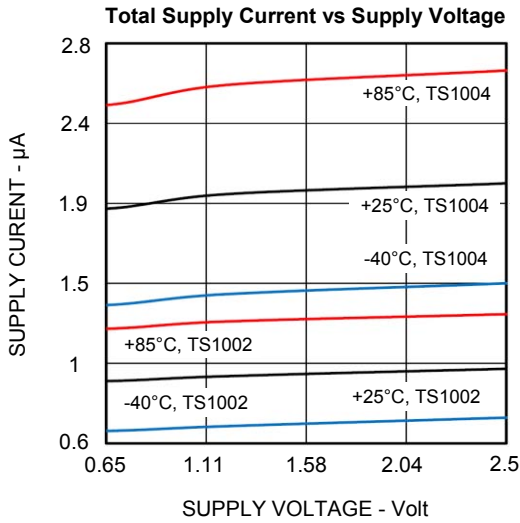

## TYPICAL PERFORMANCE CHARACTERISTICS

Input Bias Current ( $I_{IN+}$ ,  $I_{IN-}$ ) vs Input Common-Mode Voltage

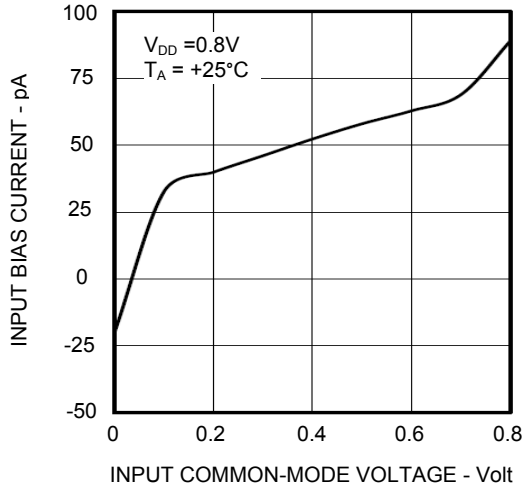

Input Bias Current ( $I_{IN+}$ ,  $I_{IN-}$ ) vs Input Common-Mode Voltage

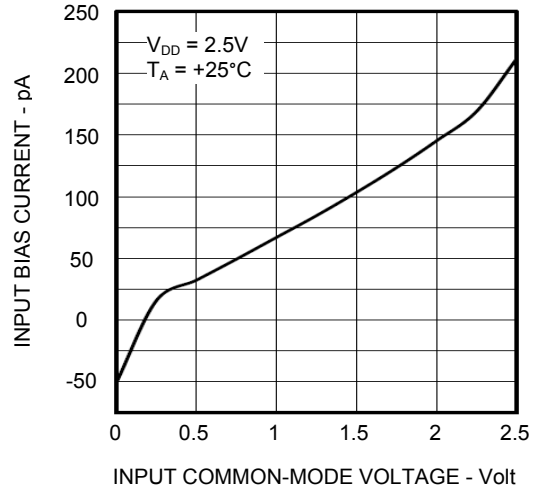

Output Voltage High ( $V_{OH}$ ) vs Temperature,  $R_{LOAD} = 100k\Omega$

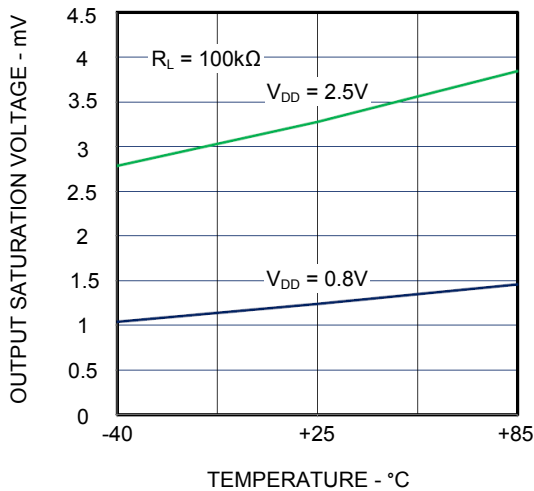

Output Voltage Low ( $V_{OL}$ ) vs Temperature,  $R_{LOAD} = 100k\Omega$

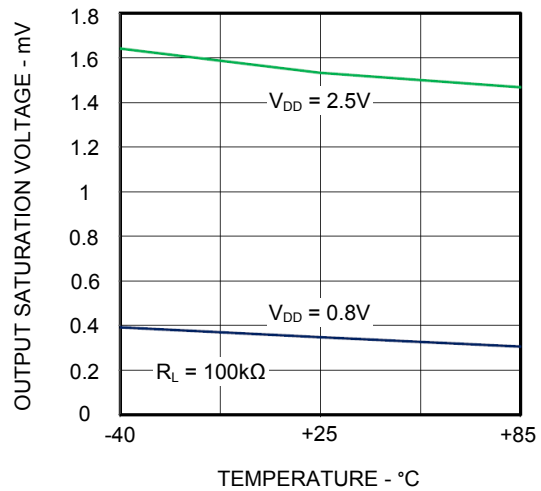

Output Voltage High ( $V_{OH}$ ) vs Temperature,  $R_{LOAD} = 10k\Omega$

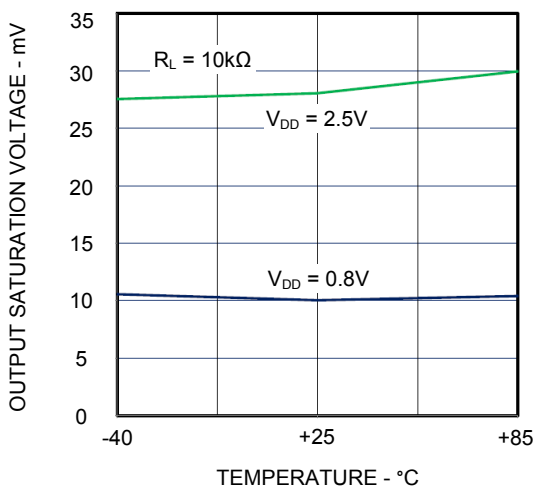

Output Voltage Low ( $V_{OL}$ ) vs Temperature,  $R_{LOAD} = 10k\Omega$

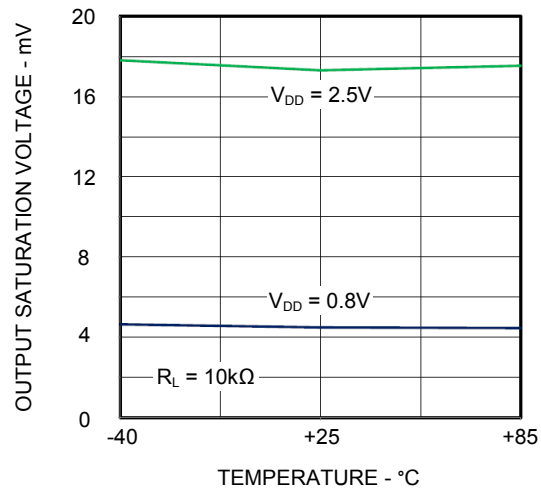

## TYPICAL PERFORMANCE CHARACTERISTICS

Output Short Circuit Current,  $I_{SC+}$  vs Temperature

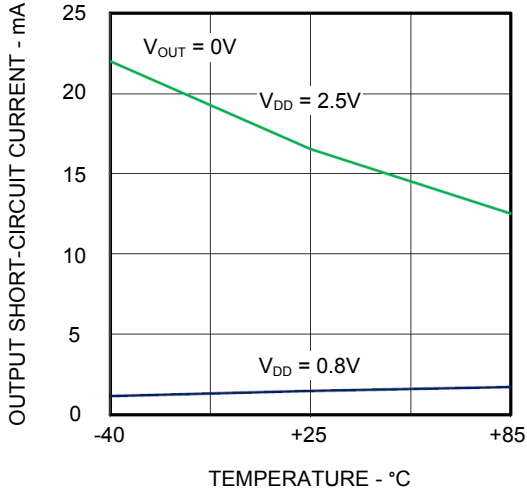

Output Short Circuit Current,  $I_{SC-}$  vs Temperature

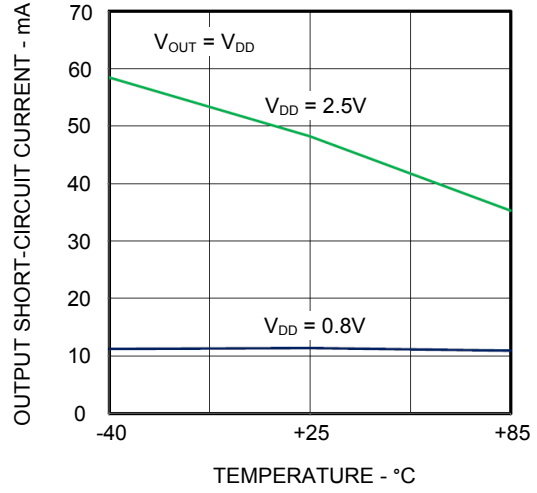

Gain and Phase vs. Frequency

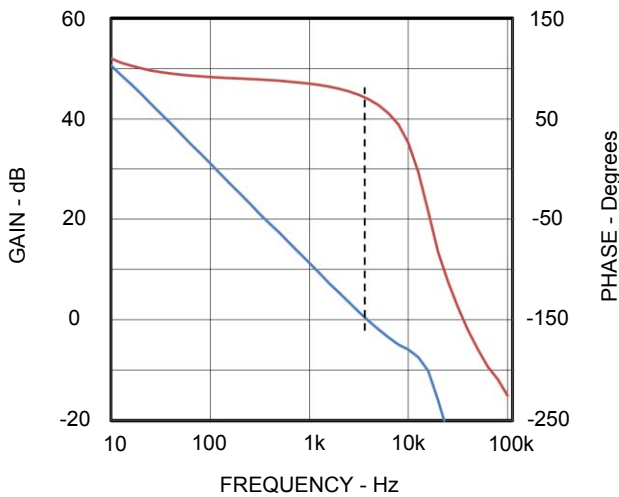

0.1Hz to 10Hz Output Voltage Noise

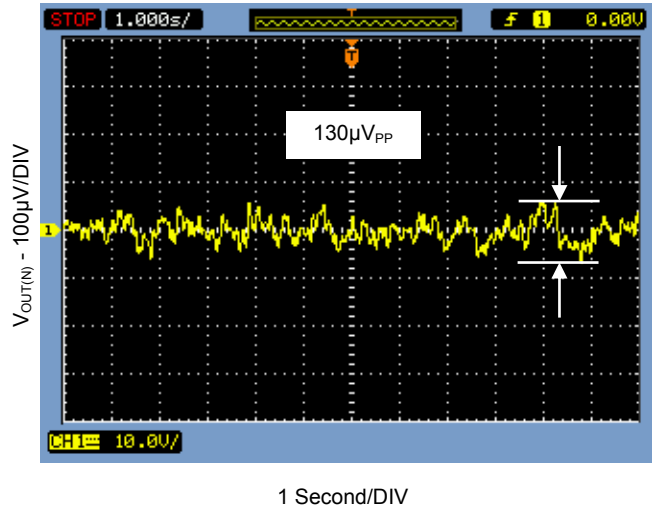

Small-Signal Transient Response  
 $V_{DD} = 2.5V$ ,  $V_{SS} = GND$ ,  $R_{LOAD} = 100k\Omega$ ,  $C_{LOAD} = 15pF$

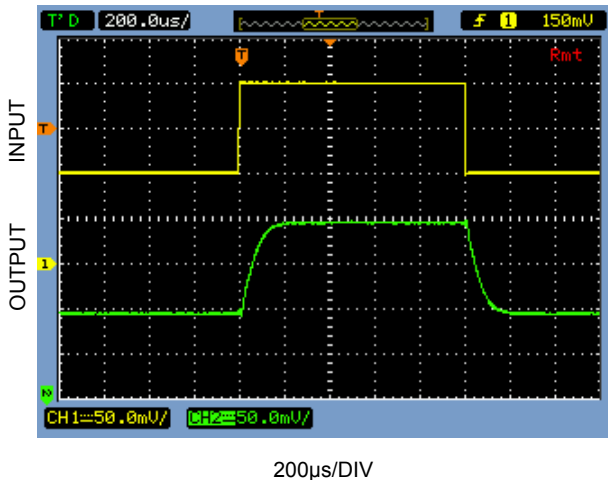

Large-Signal Transient Response  
 $V_{DD} = 2.5V$ ,  $V_{SS} = GND$ ,  $R_{LOAD} = 100k\Omega$ ,  $C_{LOAD} = 15pF$

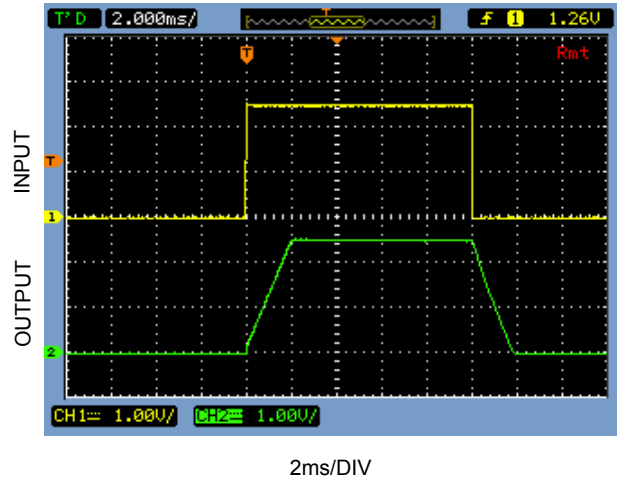

## PIN FUNCTIONS

Pin		Label	Function
TS1002 MSOP	TS1004 TSSOP		
1, 7	1, 7, 8, 14	OUT	Amplifier Outputs: A, B – TS1002; A, B, C, D – TS1004
4	7	V <sub>SS</sub>	Negative Supply or Analog GND. If applying a negative voltage to this pin, connect a 0.1µF capacitor from this pin to analog GND.
3, 5	3, 5, 10, 12	+IN	Amplifier Non-inverting Inputs: A, B – TS1002; A, B, C, D – TS1004
2, 6	2, 6, 9, 13	-IN	Amplifier Inverting Inputs: A, B – TS1002; A, B, C, D – TS1004
8	14	V <sub>DD</sub>	Positive Supply Connection. Connect a 0.1µF bypass capacitor from this pin to analog GND.

## THEORY OF OPERATION

The TS1002 and the TS1004 are fully functional for input signals from the negative supply (V<sub>SS</sub> or GND) to the positive supply (V<sub>DD</sub>). Their input stages consist of two differential amplifiers, a p-channel CMOS stage and an n-channel CMOS stage that are active over different ranges of the input common mode voltage. The p-channel input pair is active for input common mode voltages, V<sub>INCM</sub>, between the negative supply to approximately 0.4V below the positive supply. As the common-mode input voltage moves closer towards V<sub>DD</sub>, an internal current mirror activates the n-channel input pair differential pair. The p-channel input pair becomes inactive for the balance of the input common mode voltage range up to the positive supply. Because both input stages have their own offset voltage (V<sub>OS</sub>) characteristic, the offset voltage of these amplifiers is a function of the applied input common-mode voltage, V<sub>INCM</sub>. The V<sub>OS</sub> has a crossover point at ~0.4V from V<sub>DD</sub> (Refer to the V<sub>OS</sub> vs. V<sub>CM</sub> curve in the Typical Operating Characteristics section). Caution should be taken in applications where the input signal amplitude is comparable to the amplifiers' V<sub>OS</sub> value and/or the

design requires high accuracy. In these situations, it is necessary for the input signal to avoid the crossover point. In addition, amplifier parameters such as PSRR and CMRR which involve the input offset voltage will also be affected by changes in the input common-mode voltage across the differential pair transition region.

The amplifiers' second stage is a folded-cascode transistor arrangement that converts the input stage differential signals into a single-ended output. A complementary drive generator supplies current to the output transistors that swing rail to rail.

The amplifiers' output stage voltage swings within 1.2mV from the rails at 0.8V supply when driving an output load of 100kΩ - which provides the maximum possible dynamic range at the output. This is particularly important when operating on low supply voltages. When driving a stiffer 10kΩ load, the amplifiers' output swings within 10mV of V<sub>DD</sub> and within 5mV of V<sub>SS</sub> (or GND).

## APPLICATIONS INFORMATION

### Portable Gas Detection Sensor Amplifier

Gas sensors are used in many different industrial and medical applications. Gas sensors generate a current that is proportional to the percentage of a particular gas concentration sensed in an air sample. This output current flows through a load resistor and the resultant voltage drop is amplified. Depending on the sensed gas and sensitivity of the sensor, the output current can be in the range of tens of microamperes to a few milliamperes. Gas

sensor datasheets often specify a recommended load resistor value or a range of load resistors from which to choose.

There are two main applications for oxygen sensors – applications which sense oxygen when it is abundantly present (that is, in air or near an oxygen tank) and those which detect traces of oxygen in parts-per-million concentration. In medical applications, oxygen sensors are used when air quality or oxygen delivered to a patient needs to be monitored. In fresh air, the concentration of oxygen

is 20.9% and air samples containing less than 18% oxygen are considered dangerous. In industrial applications, oxygen sensors are used to detect the absence of oxygen; for example, vacuum-packaging of food products is one example.

The circuit in Figure 1 illustrates a typical implementation used to amplify the output of an oxygen detector. Either amplifier makes an

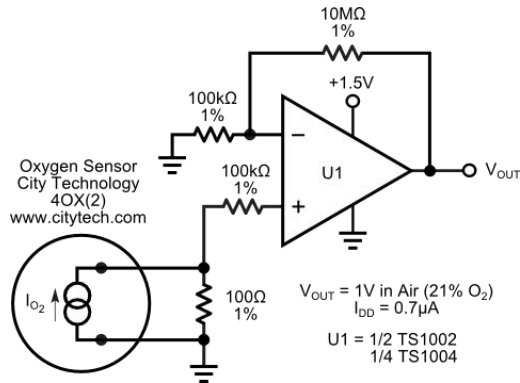
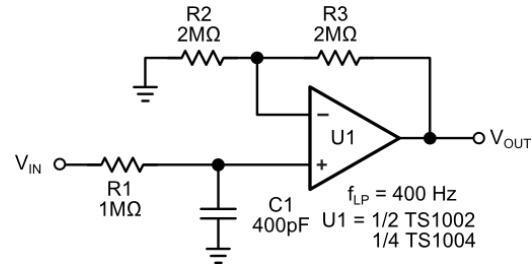

**Figure 1:** A Nanopower, Precision Oxygen Gas Sensor Amplifier.

excellent choice for this application as it only draws 0.6μA of supply current per amplifier and operates on supply voltages down to 0.65V. With the components shown in the figure, the circuit consumes less than 0.7 μA of supply current ensuring that small form-factor single- or button-cell batteries (exhibiting low mAh charge ratings) could last beyond the operating life of the oxygen sensor. The precision specifications of these amplifiers, such as their low offset voltage, low TCV<sub>OS</sub>, low input bias current, high CMRR, and high PSRR are other factors which make these amplifiers excellent choices for this application. Since oxygen sensors typically exhibit an operating life of one to two years, an oxygen sensor amplifier built around one of these amplifiers can operate from a conventionally-available single 1.5-V alkaline AA battery for over 290 years! At such low power consumption from a single cell, the oxygen sensor could be replaced over 150 times before the battery requires replacing!

### NanoWatt, Buffered Single-pole Low-Pass Filters

When receiving low-level signals, limiting the bandwidth of the incoming signals into the system is often required. As shown in Figure 2, the simplest way to achieve this objective is to use an RC filter at the noninverting terminal of the amplifier.



**Figure 2:** A Simple, Single-pole Active Low-Pass Filter.

If additional attenuation is needed, a two-pole Sallen-Key filter can be used to provide the additional attenuation as shown in Figure 3.

For best results, the filter's cutoff frequency should be 8 to 10 times lower than the amplifier's crossover

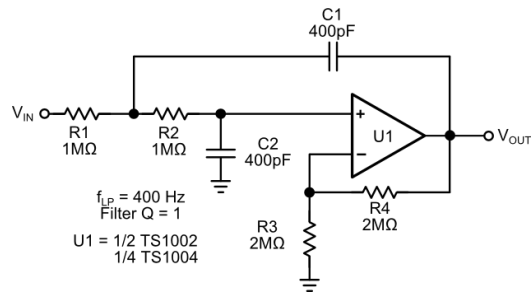

**Figure 3:** A Nanopower 2-Pole Sallen-Key Low-Pass Filter.

frequency. Additional operational amplifier phase margin shift can be avoided if the amplifier bandwidth-to-signal bandwidth ratio is greater than 8.

The design equations for the 2-pole Sallen-Key low-pass filter are given below with component values selected to set a 400Hz low-pass filter cutoff frequency:

$$\begin{aligned}
 R1 &= R2 = R = 1\text{M}\Omega \\
 C1 &= C2 = C = 400\text{pF} \\
 Q &= \text{Filter Peaking Factor} = 1 \\
 f_{-3\text{dB}} &= 1/(2 \times \pi \times RC) = 400\text{ Hz} \\
 R3 &= R4/(2-1/Q); \text{ with } Q = 1, R3 = R4.
 \end{aligned}$$

### A Single +1.5 V Supply, Two Op Amp Instrumentation Amplifier

The amplifiers' ultra-low supply current and ultra-low voltage operation make them ideal for battery-powered applications such as the instrumentation amplifier shown in Figure 4 using a TS1002.



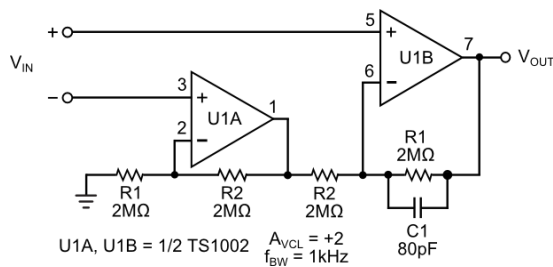

**Figure 4:** A Two Op Amp Instrumentation Amplifier.

The circuit utilizes the classic two op amp instrumentation amplifier topology with four resistors to set the gain. The equation is simply that of a noninverting amplifier as shown in the figure. The two resistors labeled R1 should be closely matched to each other as well as both resistors labeled R2 to ensure acceptable common-mode rejection performance.

Resistor networks ensure the closest matching as well as matched drifts for good temperature stability. Capacitor C1 is included to limit the bandwidth and, therefore, the noise in sensitive applications. The value of this capacitor should be adjusted depending on the desired closed-loop bandwidth of the instrumentation amplifier. The RC combination creates a pole at a frequency equal to  $1/(2 \pi \times R1C1)$ . If the AC-CMRR is critical, then a matched capacitor to C1 should be included across the second resistor labeled R1.

Because these amplifiers accept rail-to-rail inputs, their input common mode range includes both ground and the positive supply of 1.5V. Furthermore, their rail-to-rail output range ensures the widest signal range possible and maximizes the dynamic range of the system. Also, with their low supply current of 0.6 $\mu$ A per amplifier, this circuit consumes a quiescent current of only  $\sim 1.3\mu$ A, yet it still exhibits a 1-kHz bandwidth at a circuit gain of 2.

### Driving Capacitive Loads

While the amplifiers' internal gain-bandwidth product is 4kHz, both are capable of driving capacitive loads up to 50pF in voltage follower configurations without any additional components. In many applications, however, an operational amplifier is required to drive much larger capacitive loads. The amplifier's output impedance and a large capacitive load create additional phase lag that further reduces the amplifier's phase margin. If enough phase delay is introduced, the amplifier's phase margin is reduced. The effect is quite evident when the transient

response is observed as there will appear noticeable peaking/ringing in the output transient response.

If any amplifier is used in an application that requires driving larger capacitive loads, an isolation resistor between the output and the capacitive load should be used as illustrated in Figure 5.

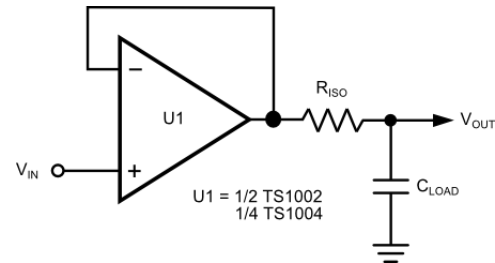
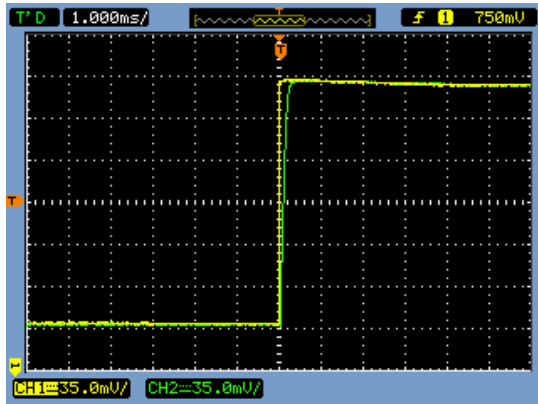

**Figure 5:** Using an External Resistor to Isolate a  $C_{LOAD}$  from the Amplifier's Output.

Table 1 illustrates a range of  $R_{ISO}$  values as a function of the external  $C_{LOAD}$  on the output of these amplifiers. The power supply voltage applied on the these amplifiers at which these resistor values were determined empirically was 1.8V. The oscilloscope capture shown in Figure 6 illustrates a typical transient response obtained with a  $C_{LOAD} = 500$ pF and an  $R_{ISO} = 50$ k $\Omega$ . Note that as  $C_{LOAD}$  is increased a smaller  $R_{ISO}$  is needed for optimal transient response.

External Capacitive Load, $C_{LOAD}$	External Output Isolation Resistor, $R_{ISO}$
0-50pF	Not Required
100pF	120k $\Omega$
500pF	50k $\Omega$
1nF	33k $\Omega$
5nF	18k $\Omega$
10nF	13k $\Omega$

In the event that an external  $R_{LOAD}$  in parallel with  $C_{LOAD}$  appears in the application, the use of an  $R_{ISO}$  results in gain accuracy loss because the external series  $R_{ISO}$  forms a voltage-divider with the external load resistor  $R_{LOAD}$ .



**Figure 6:** TS1002/TS1004 Transient Response for  $R_{ISO} = 50k\Omega$  and  $C_{LOAD} = 500pF$ .

## Configuring the TS1002 or the TS1004 into a Nanowatt Analog Comparator

Although optimized for use as an operational amplifier, these amplifiers can also be used as a rail-to-rail I/O comparator as illustrated in Figure 7.

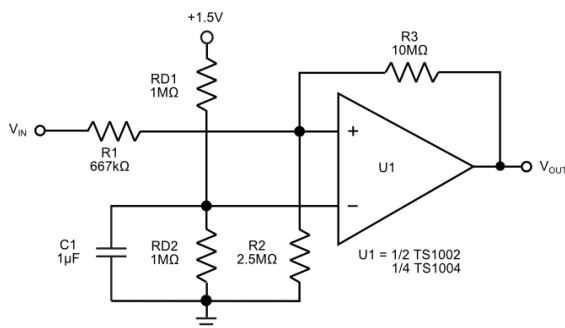

**Figure 7:** A NanoWatt Analog Comparator with User-Programmable Hysteresis.

External hysteresis can be employed to minimize the risk of output oscillation. The positive feedback circuit causes the input threshold to change when the output voltage changes state. The diagram in Figure 8 illustrates the amplifiers' analog comparator hysteresis band and output transfer characteristic.

The design of an analog comparator using the TS1002 or the TS1004 is straightforward. In this application, a 1.5-V power supply ( $V_{DD}$ ) was used and the resistor divider network formed by  $RD1$  and  $RD2$  generated a convenient reference voltage

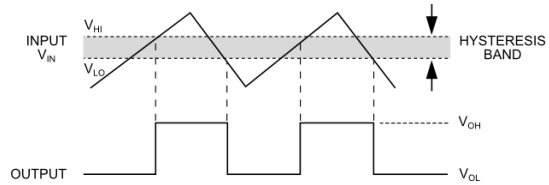

**Figure 8:** Analog Comparator Hysteresis Band and Output Switching Points.

( $V_{REF}$ ) for the circuit at  $\frac{1}{2}$  the supply voltage, or 0.75V, while keeping the current drawn by this resistor divider low. Capacitor  $C1$  is used to filter any extraneous noise that could couple into the amplifier's inverting input.

In this application, the desired hysteresis band was set to 100mV ( $V_{HYB}$ ) with a desired high trip-point ( $V_{HI}$ ) set at 1V and a desired low trip-point ( $V_{LO}$ ) set at 0.9V.

Since these amplifiers draw very little supply current (0.6μA per amplifier, typical), it is desired that the design of an analog comparator using these amplifiers should also use as little current as practical. The first step in the design, therefore, was to set the feedback resistor  $R3$ :

$$R3 = 10M\Omega$$

Calculating a value for  $R1$  is given by the following expression:

$$R1 = R3 \times (V_{HYB}/V_{DD})$$

Substituting  $V_{HYB} = 100mV$ ,  $V_{DD} = 1.5V$ , and  $R3 = 10M\Omega$  into the equation above yields:

$$R1 = 667k\Omega$$

The following expression was then used to calculate a value for  $R2$ :

$$R2 = 1/[V_{HI}/(V_{REF} \times R1) - (1/R1) - (1/R3)]$$

Substituting  $V_{HI} = 1V$ ,  $V_{REF} = 0.75V$ ,  $R1 = 667k\Omega$ , and  $R3 = 10M\Omega$  into the above expression yields:

$$R2 = 2.5M\Omega$$

## Printed Circuit Board Layout Considerations

Even though these amplifiers operate from a single 0.65V to 2.5V power supply and consume very little supply current, it is always good engineering practice to bypass the power supplies pins with a 0.1 $\mu$ F ceramic capacitor placed in close proximity to the V<sub>DD</sub> and V<sub>SS</sub> (or GND) pins.

Good pcb layout techniques and analog ground plane management improve the performance of any analog circuit by decreasing the amount of stray

capacitance that could be introduced at the op amp's inputs and outputs. Excess stray capacitance can easily couple noise into the input leads of the op amp and excess stray capacitance at the output will add to any external capacitive load. Therefore, PC board trace lengths and external component leads should be kept as short as practical to any of the amplifiers' package pins. Second, it is also good engineering practice to route/remove any analog ground plane from the inputs and the output pins of these amplifiers.

## PACKAGE OUTLINE DRAWING

### 8-Pin MSOP Package Outline Drawing

(N.B., Drawings are not to scale)

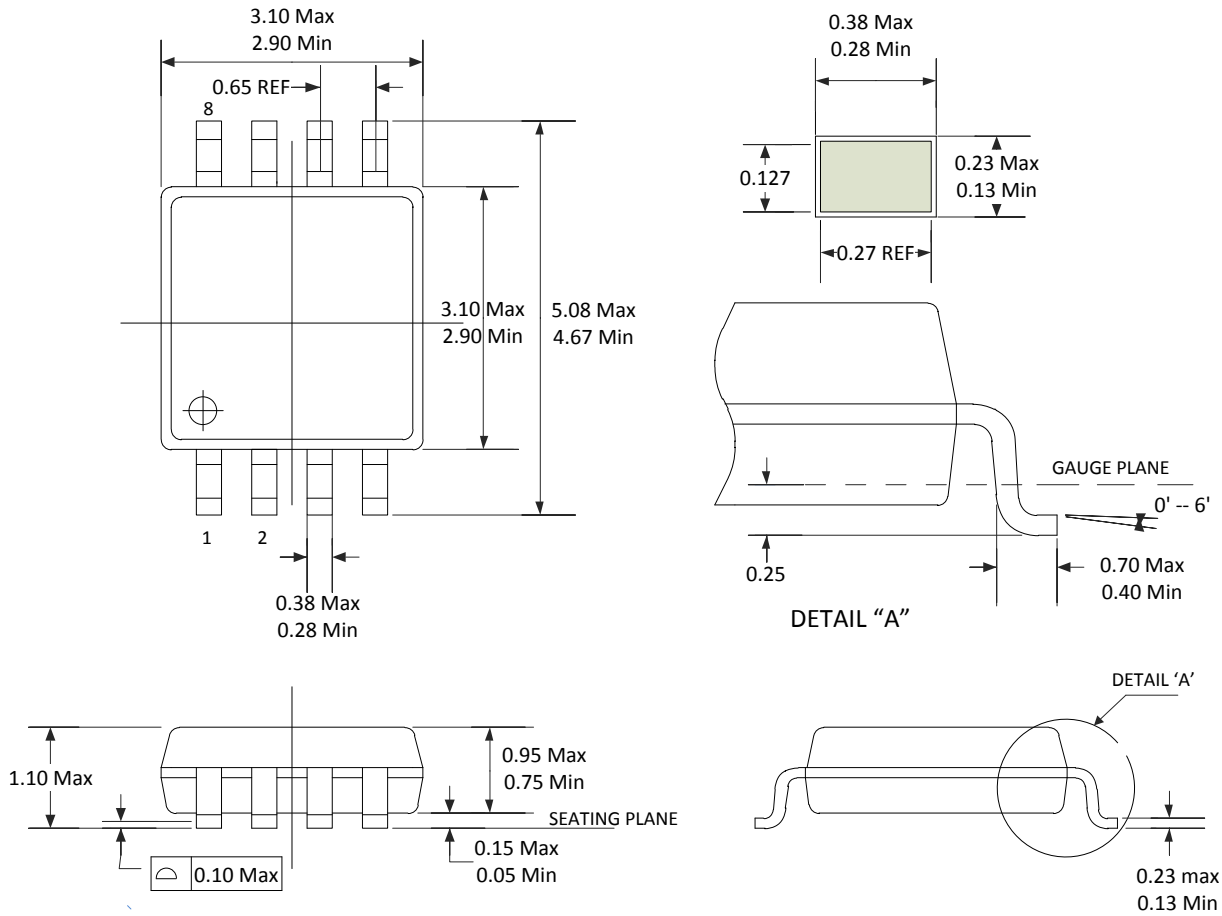

**NOTE:**

1. PACKAGE LENGTH DOES NOT INCLUDE MOLD FLASH, PROTRUSIONS OR GATE BURRS.
2. PACKAGE WIDTH DOES NOT INCLUDE INTERLEAD FLASH OR PROTUSIONS.
3. CONTROLLING DIMENSION IN MILLIMETERS.
4. THIS PART IS COMPLIANT WITH JEDEC MO-187 VARIATIONS AA
5. LEAD SPAN/STAND OFF HEIGHT/COPLANARITY ARE CONSIDERED AS SPECIAL CHARACTERISTIC.



SILICON LABS

# PACKAGE OUTLINE DRAWING

# TS1002/TS1004

## 14-Pin TSSOP Package Outline Drawing

(N.B., Drawings are not to scale)

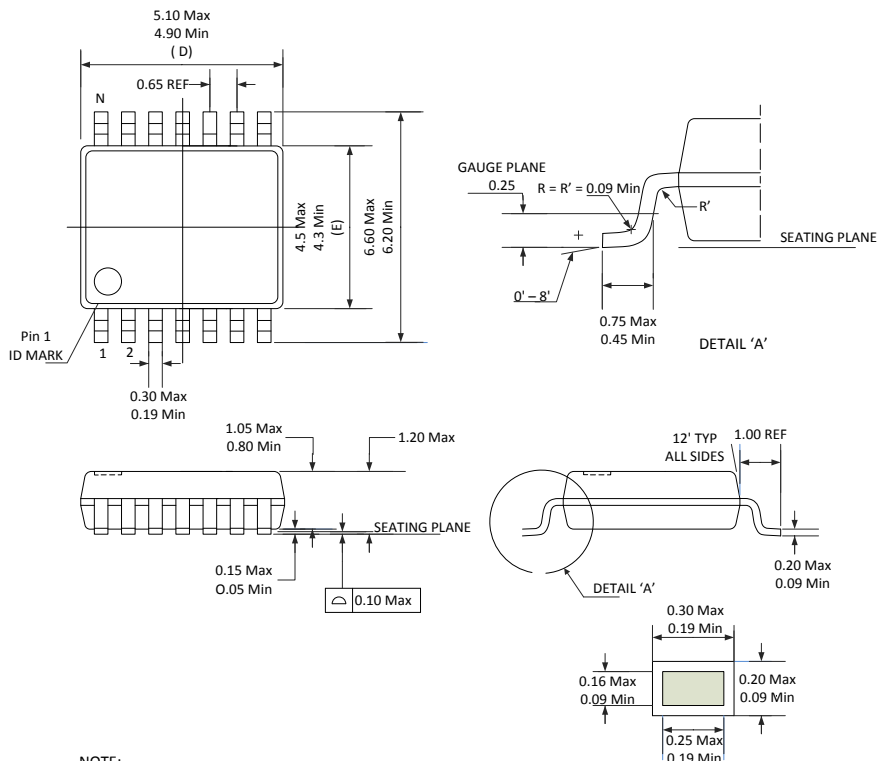

**NOTE:**

1. "D" AND "E" ARE REFERENCE DATUMS AND DOES NOT INCLUDE MOLD FLASH, PROTRUSIONS OR GATE BURRS. MOLD FLASH, PROTRUSIONS OR GATE BURRS SHALL NOT EXCEED 0.15 mm PER SIDE.
2. "N" IS THE NUMBER OF TERMINAL POSITIONS.
3. CONTROLLING DIMENSION IN MILLIMETERS AND ANGLES IN DEGREES.
4. THIS PART IS COMPLIANT WITH JEDEC SPECIFICATION MO-153 AB-1
5. LEAD SPAN/STAND OFF HEIGHT/COPLANARITY ARE CONSIDERED AS SPECIAL CHARACTERISTIC.

### Patent Notice

Silicon Labs invests in research and development to help our customers differentiate in the market with innovative low-power, small size, analog-intensive mixed-signal solutions. Silicon Labs' extensive patent portfolio is a testament to our unique approach and world-class engineering team.

The information in this document is believed to be accurate in all respects at the time of publication but is subject to change without notice. Silicon Laboratories assumes no responsibility for errors and omissions, and disclaims responsibility for any consequences resulting from the use of information included herein. Additionally, Silicon Laboratories assumes no responsibility for the functioning of undescribed features or parameters. Silicon Laboratories reserves the right to make changes without further notice. Silicon Laboratories makes no warranty, representation or guarantee regarding the suitability of its products for any particular purpose, nor does Silicon Laboratories assume any liability arising out of the application or use of any product or circuit, and specifically disclaims any and all liability, including without limitation consequential or incidental damages. Silicon Laboratories products are not designed, intended, or authorized for use in applications intended to support or sustain life, or for any other application in which the failure of the Silicon Laboratories product could create a situation where personal injury or death may occur. Should Buyer purchase or use Silicon Laboratories products for any such unintended or unauthorized application, Buyer shall indemnify and hold Silicon Laboratories harmless against all claims and damages.

Silicon Laboratories and Silicon Labs are trademarks of Silicon Laboratories Inc. Other products or brandnames mentioned herein are trademarks or registered trademarks of their respective holders.