

# TS1108 Data Sheet

## TS1108 Coulomb Counter: Bidirectional Current Sense Amplifier with Integrator + Comparator

The TS1108 coulomb counter accurately measures battery depletion while also indicating the battery charging polarity. The battery discharge current is monitored by a current-sense amplifier through an external sense resistor. Utilizing an Integrator and a Comparator plus a Monoshot, the TS1108 voltage-to-frequency converter provides a series of 90  $\mu$ s output pulses at COUT which represents an accumulation of coulombs flowing out of the battery. The charge count frequency is adjustable by the integration resistor and capacitor.

### Applications

- Power Management Systems
- Portable/Battery-Powered Systems
- Smart Chargers

### KEY FEATURES

- Coulomb Counting plus Charge Polarity
- Adjustable Charge Count Frequency
- External Crystal Oscillator Not Required
- Low Supply Current
  - Current Sense Amplifier: 0.68  $\mu$ A
  - $I_{VDD}$ : 1.93  $\mu$ A
- High Side Bidirectional Current Sense Amplifier
- Wide CSA Input Common Mode Range: +2 V to +27 V
- Low CSA Input Offset Voltage: 150  $\mu$ V(max)
- Low Gain Error: 1%(max)
- Two Gain Options Available:
  - Gain = 20 V/V : TS1108-20
  - Gain = 200 V/V : TS1108-200
- 16-Pin TQFN Packaging (3 mm x 3 mm)

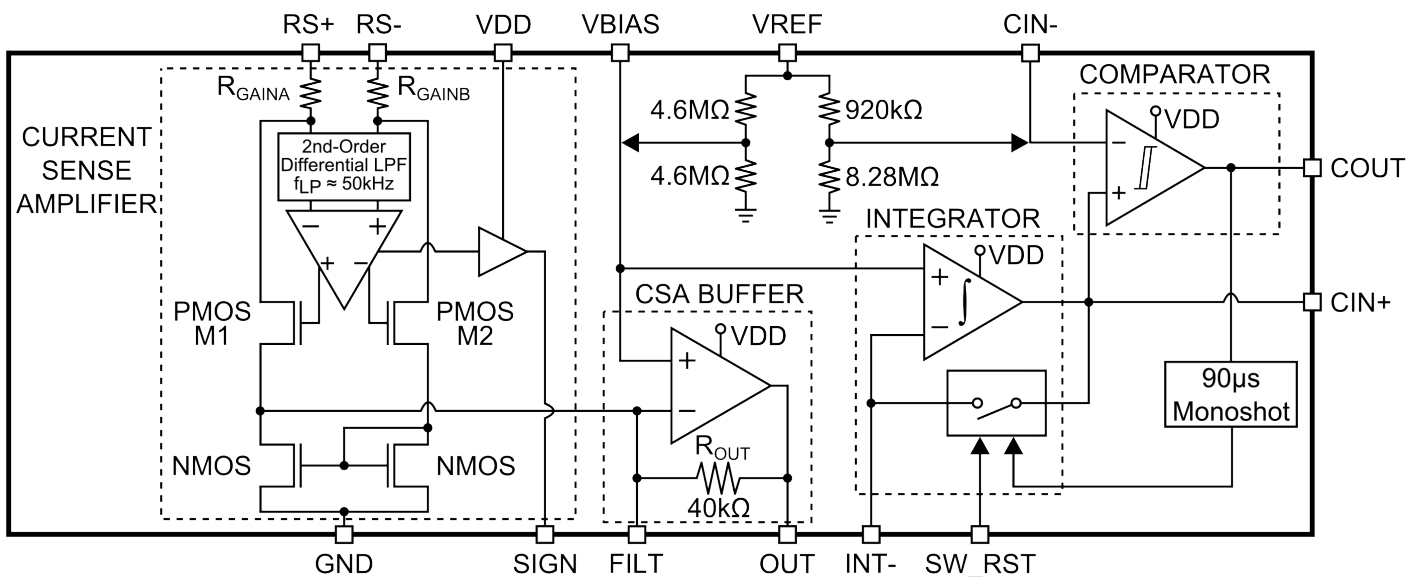

## 1. Ordering Information

**Table 1.1. Ordering Part Numbers**

Ordering Part Number	Description	Gain V/V
TS1108-20ITQ1633	Coulomb counter: Bidirectional current sense amplifier with integrator and comparator	20
TS1108-200ITQ1633	Coulomb counter: Bidirectional current sense amplifier with integrator and comparator	200
<p><b>Note:</b> Adding the suffix “T” to the part number (e.g. TS1108-200ITQ1633T) denotes tape and reel.</p>		

## 2. System Overview

### 2.1 Functional Block Diagram

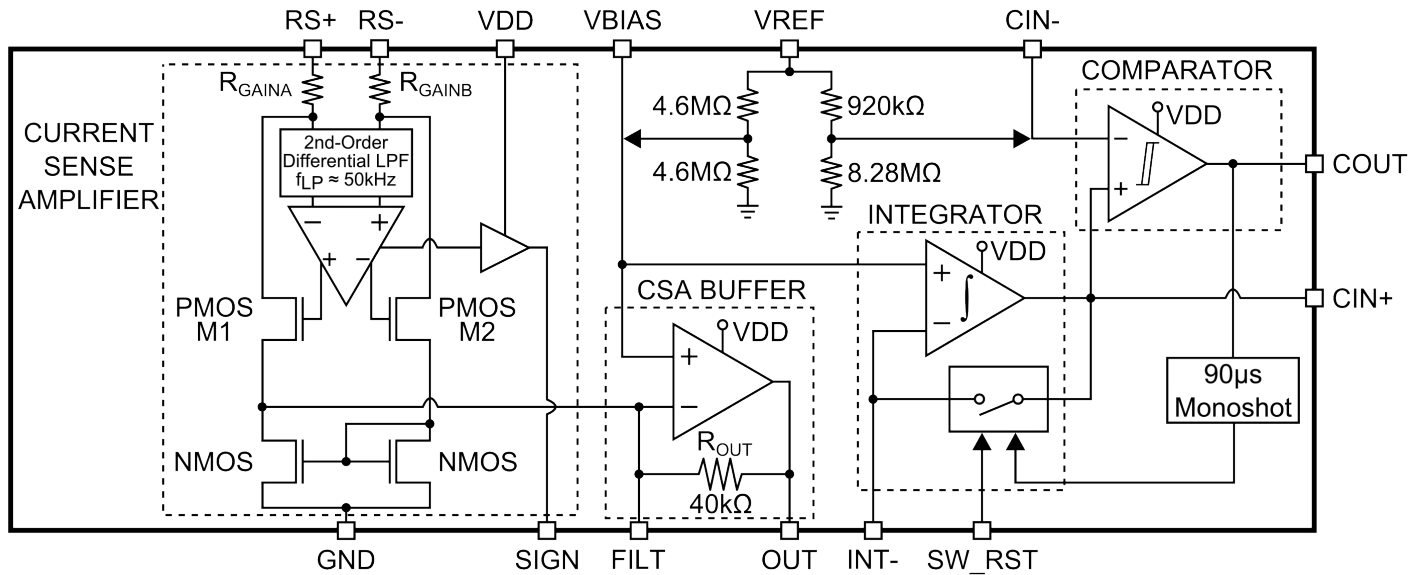

Figure 2.1. TS1108 Coulomb Counter Block Diagram

## 2.2 Current Sense Amplifier + Output Buffer

The internal configuration of the TS1108 bidirectional current-sense amplifier is a variation of the TS1101 bidirectional current-sense amplifier. The TS1108 current-sense amplifier is configured for fully differential input/output operation.

Referring to the block diagram, the inputs of the TS1108's differential input/output amplifier are connected to RS+ and RS– across an external R<sub>SENSE</sub> resistor that is used to measure current. At the non-inverting input of the current-sense amplifier, the applied voltage difference in voltage between RS+ and RS– is I<sub>LOAD</sub> × R<sub>SENSE</sub>. Since the RS– terminal is the non-inverting input of the internal op-amp, the current-sense op-amp action drives PMOS[1/2] to drive current across R<sub>GAIN[A/B]</sub> to equalize voltage at its inputs.

Thus, since the M1 PMOS source is connected to the inverting input of the internal op-amp and since the voltage drop across R<sub>GAINA</sub> is the same as the external V<sub>SENSE</sub>, the M1 PMOS drain-source current is equal to:

$$I_{DS(M1)} = \frac{V_{SENSE}}{R_{GAINA}}$$

$$I_{DS(M1)} = \frac{I_{LOAD} \times R_{SENSE}}{R_{GAINA}}$$

The drain terminal of the M1 PMOS is connected to the transimpedance amplifier's gain resistor, R<sub>OUT</sub>, via the inverting terminal. The non-inverting terminal of the transimpedance amplifier is internally connected to VBIAS, therefore the output voltage of the TS1108 at the OUT terminal is:

$$V_{OUT} = V_{BIAS} - I_{LOAD} \times R_{SENSE} \times \frac{R_{OUT}}{R_{GAINA}}$$

When the voltage at the RS– terminal is greater than the voltage at the RS+ terminal, the external V<sub>SENSE</sub> voltage drop is impressed upon R<sub>GAINB</sub>. The voltage drop across R<sub>GAINB</sub> is then converted into a current by the M2 PMOS. The M2 PMOS' drain-source current is the input current for the NMOS current mirror which is matched with a 1-to-1 ratio. The transimpedance amplifier sources the M2 PMOS drain-source current for the NMOS current mirror. Therefore the output voltage of the TS1108 at the OUT terminal is:

$$V_{OUT} = V_{BIAS} + I_{LOAD} \times R_{SENSE} \times \frac{R_{OUT}}{R_{GAINB}}$$

When M1 is conducting current (V<sub>RS+</sub> > V<sub>RS-</sub>), the TS1108's internal amplifier holds M2 OFF. When M2 is conducting current (V<sub>RS-</sub> > V<sub>RS+</sub>), the internal amplifier holds M1 OFF. In either case, the disabled PMOS does not contribute to the resultant output voltage.

The current-sense amplifier's gain accuracy is therefore the ratio match of R<sub>OUT</sub> to R<sub>GAIN[A/B]</sub>. For each of the two gain options available, The following table lists the values for R<sub>GAIN[A/B]</sub>.

**Table 2.1. Internal Gain Setting Resistors (Typical Values)**

GAIN (V/V)	R <sub>GAIN[A/B]</sub> (Ω)	R <sub>OUT</sub> (Ω)	Part Number
20	2 k	40 k	TS1108-20
200	200	40 k	TS1108-200

The TS1108 allows access to the inverting terminal of the transimpedance amplifier by the FILT pin, whereby a series RC filter may be connected to reduce noise at the OUT terminal. The recommended RC filter is 4 kΩ and 0.47 μF connected in series from FILT to GND to suppress the noise. Any capacitance at the OUT terminal should be minimized for stable operation of the buffer.

## 2.3 Sign Output

The TS1108 SIGN output indicates the load current's direction. The SIGN output is a logic HIGH when M1 is conducting current ( $V_{RS+} > V_{RS-}$ ). Alternatively, the SIGN output is a logic LOW when M2 is conducting current ( $V_{RS-} > V_{RS+}$ ). The SIGN comparator's transfer characteristic is illustrated in Figure 1. Unlike other current-sense amplifiers that implement an OUT/SIGN arrangement, the TS1108 exhibits no "dead zone" at  $I_{LOAD}$  switchover.

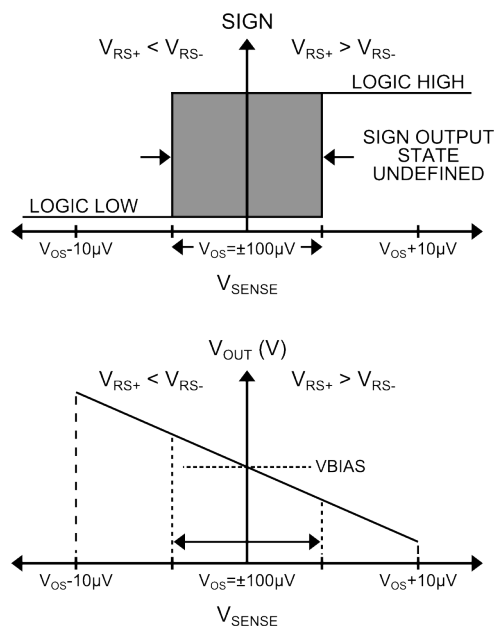

Figure 2.2. TS1108 Sign Output Transfer Characteristic

## 2.4 Integrator + Comparator

The TS1108 Coulomb Counter function utilizes an Integrator and a Comparator plus a 90  $\mu$ s Monoshot. The CSA's buffered output is applied to the integrator's input. This signal is integrated by the comparator until it reaches a level that trips the comparator. The comparator's trip level is determined by the voltage applied to the comparator's non-inverting terminal,  $C_{IN+}$ . The Monoshot produces a 90  $\mu$ s output pulse at  $C_{OUT}$  and the integrator is reset. Therefore, each  $C_{OUT}$  90  $\mu$ s pulse represents an accumulation of coulombs (Please refer to the equations in 2.6 Coulomb Counter). The TS1108 Integrator works best when the 90  $\mu$ s Monoshot represents less than 2% of the total integration period. Therefore, the minimum integration time for a full-scale  $V_{SENSE}$  should be limited to 4.7 ms. To guarantee stable operation of the  $C_{OUT}$  buffer, an integration capacitance of 0.1  $\mu$ F should be used for integration capacitor,  $C_{INT}$ . The maximum integration period can be very long, limited by the leakage current and offset.

A reset switch is configured internally to discharge the external integration capacitor,  $C_{INT}$ . To enable the Coulomb Counting feature,  $SW\_RST$  should be tied to either GND or  $C_{OUT}$ , allowing the 90  $\mu$ s Monoshot Pulse to control the discharge of  $C_{INT}$ . To close the reset switch and short out  $C_{INT}$ ,  $SW\_RST$  may be tied high.

TS1108's Coulomb Counting interrupt is provided by the internal comparator with a push-pull output configuration. As shown in the block diagram, the integrator's output is applied internally to the non-inverting terminal of the comparator,  $C_{IN+}$ . Therefore the comparator's output will latch high for 90  $\mu$ s once the integrator's output is charged to the voltage supplied to the comparator's inverting terminal,  $C_{IN-}$ . The inverting terminal of the comparator,  $C_{IN-}$ , must be at a higher potential than the voltage supplied to  $V_{BIAS}$  for proper operation. The capacitive load at  $C_{OUT}$  should be minimized for minimal output delays.

## 2.5 VREF Divider

The TS1108 provides an internal voltage divider network to set  $V_{BIAS}$  and  $C_{IN-}$ , eliminating the need for externally setting the required voltages. The VREF Divider is activated once the voltage applied to  $V_{REF}$  is 0.9 V or greater. The VREF divider connects to  $V_{BIAS}$  and  $C_{IN-}$ , where the  $V_{BIAS}$  voltage is equal to 50% of  $V_{REF}$  while the  $C_{IN-}$  voltage is equal to 90% of  $V_{REF}$ . The VREF Divider exhibits a typical total series resistance of 4.6 M $\Omega$  from  $V_{REF}$  to GND when activated.

## 2.6 Coulomb Counter

The amount of charge, or coulombs, over time is measured by the integration of current. The TS1108 Coulomb Counter measures the charge consumed by the load by integrating the voltage output of the Current Sense Amplifier, thereby converting the sensed current at the CSA's applied input into a measurement of coulombs. The comparator's output represents a measurement of coulombs per output pulse. The period of the comparator's output pulses is defined by:

$$t_{COUT} = \frac{R_{INT} C_{INT} (V_{CIN-} - V_{VBIAS})}{GAIN \times V_{SENSE}}$$

Since a coulomb is defined as the multiplication of current and time, the quantity of coulombs per comparator output pulse can be defined as:

$$OneComparatorOutputPulse = \frac{R_{INT} C_{INT} (V_{CIN-} - V_{VBIAS})}{GAIN \times R_{SENSE}} \text{Coulombs}$$

The comparator's output pulse can also quantify the ampere-hours (Ah) of battery charge, as most battery manufacturers specify a battery's capacity in ampere-hours.

$$OneComparatorOutputPulse = \frac{R_{INT} C_{INT} (V_{CIN-} - V_{VBIAS})}{3600 \times GAIN \times R_{SENSE}} \text{Ah}$$

It should be noted that the sense resistor value,  $R_{SENSE}$ , should not be used to adjust the relationship between coulombs and the applied sense current to the CSA's input. The integration resistor,  $R_{INT}$ , and the comparator's upper limit voltage,  $V_{CIN-}$ , should be used to adjust the integration time, and therefore the comparator's output period.

## 2.7 Selecting a Sense Resistor

Selecting the optimal value for the external  $R_{SENSE}$  is based on the following criteria and for each commentary follows:

1.  $R_{SENSE}$  Voltage Loss
2.  $V_{OUT}$  Swing vs. Desired  $V_{SENSE}$  and Applied Supply Voltage at VDD
3. Total  $I_{LOAD}$  Accuracy
4. Circuit Efficiency and Power Dissipation
5.  $R_{SENSE}$  Kelvin Connections

### 2.7.1 RSENSE Voltage Loss

For lowest IR power dissipation in  $R_{SENSE}$ , the smallest usable resistor value for  $R_{SENSE}$  should be selected.

### 2.7.2 VOUT Swing vs. Desired VSENSE and Applied Supply Voltage at VDD

Although the Current Sense Amplifier draws its power from the voltage at its  $RS+$  and  $RS-$  terminals, the signal voltage at the OUT terminal is provided by a buffer, and is therefore bounded by the buffer's output range. As shown in the Electrical Characteristics table, the CSA Buffer has a maximum and minimum output voltage of:

$$V_{OUT(max)} = VDD_{(min)} - 0.2V$$

$$V_{OUT(min)} = 0.2V$$

Therefore, the full-scale sense voltage should be chosen so that the OUT voltage is neither greater nor less than the maximum and minimum output voltage defined above. To satisfy this requirement, the positive full-scale sense voltage,  $V_{SENSE(pos\_max)}$ , should be chosen so that:

$$V_{SENSE(pos\_max)} < \frac{V_{BIAS} - V_{OUT(min)}}{GAIN}$$

Likewise, the negative full-scale sense voltage,  $V_{SENSE(neg\_min)}$ , should be chosen so that:

$$V_{SENSE(neg\_min)} < \frac{V_{OUT(max)} - V_{BIAS}}{GAIN}$$

For best performance,  $R_{SENSE}$  should be chosen so that the full-scale  $V_{SENSE}$  is less than  $\pm 75$  mV.

### 2.7.3 Total Load Current Accuracy

In the TS1108's linear region where  $V_{OUT(min)} < V_{OUT} < V_{OUT(max)}$ , there are two specifications related to the circuit's accuracy: a) the TS1108 CSA's input offset voltage ( $V_{OS(max)} = 150 \mu V$ ), b) the TS1108 CSA's gain error ( $GE_{(max)} = 1\%$ ). An expression for the TS1108's total error is given by:

$$V_{OUT} = V_{BIAS} - [GAIN \times (1 \pm GE) \times V_{SENSE}] \pm (GAIN \times V_{OS})$$

A large value for  $R_{SENSE}$  permits the use of smaller load currents to be measured more accurately because the effects of offset voltages are less significant when compared to larger  $V_{SENSE}$  voltages. Due care though should be exercised as previously mentioned with large values of  $R_{SENSE}$ .

### 2.7.4 Circuit Efficiency and Power Dissipation

IR losses in  $R_{SENSE}$  can be large especially at high load currents. It is important to select the smallest, usable  $R_{SENSE}$  value to minimize power dissipation and to keep the physical size of  $R_{SENSE}$  small. If the external  $R_{SENSE}$  is allowed to dissipate significant power, then its inherent temperature coefficient may alter its design center value, thereby reducing load current measurement accuracy. Precisely because the TS1108 CSA's input stage was designed to exhibit a very low input offset voltage, small  $R_{SENSE}$  values can be used to reduce power dissipation and minimize local hot spots on the pcb.

### 2.7.5 RSENSE Kelvin Connections

For optimal  $V_{SENSE}$  accuracy in the presence of large load currents, parasitic pcb track resistance should be minimized. Kelvin-sense pcb connections between  $R_{SENSE}$  and the TS1108's RS+ and RS- terminals are strongly recommended. The drawing below illustrates the connections between the current-sense amplifier and the current-sense resistor. The pcb layout should be balanced and symmetrical to minimize wiring-induced errors. In addition, the pcb layout for  $R_{SENSE}$  should include good thermal management techniques for optimal  $R_{SENSE}$  power dissipation.

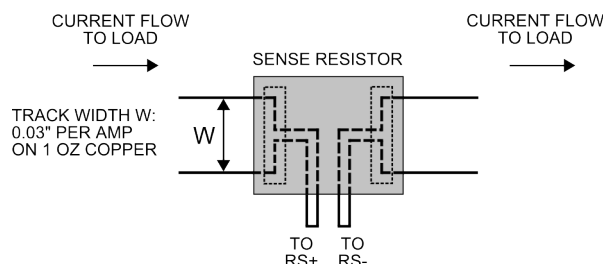

Figure 2.3. Making PCB Connections to  $R_{SENSE}$

### 2.7.6 RSENSE Composition

Current-shunt resistors are available in metal film, metal strip, and wire-wound constructions. Wire-wound current-shunt resistors are constructed with wire spirally wound onto a core. As a result, these types of current shunt resistors exhibit the largest self-inductance. In applications where the load current contains high-frequency transients, metal film or metal strip current sense resistors are recommended.

### 2.7.7 Internal Noise Filter

In power management and motor control applications, current-sense amplifiers are required to measure load currents accurately in the presence of both externally-generated differential and common-mode noise. An example of differential-mode noise that can appear at the inputs of a current-sense amplifier is high-frequency ripple. High-frequency ripple (whether injected into the circuit inductively or capacitively) can produce a differential-mode voltage drop across the external current-shunt resistor,  $R_{SENSE}$ . An example of externally-generated, common-mode noise is the high-frequency output ripple of a switching regulator that can result in common-mode noise injection into both inputs of a current-sense amplifier.

Even though the load current signal bandwidth is dc, the input stage of any current-sense amplifier can rectify unwanted out-of-band noise that can result in an apparent error voltage at its output. Against common-mode injection noise, the current-sense amplifier's internal common-mode rejection ratio is 130 dB (typ).

To counter the effects of externally-injected noise, the TS1108 incorporates a 50 kHz (typ), 2nd-order differential low-pass filter as shown in the TS1108's block diagram, thereby eliminating the need for an external low-pass filter, which can generate errors in the offset voltage and the gain error.

### 2.7.8 PC Board Layout and Power-Supply Bypassing

For optimal circuit performance, the TS1108 should be in very close proximity to the external current-sense resistor and the pcb tracks from  $R_{SENSE}$  to the  $RS+$  and the  $RS-$  input terminals of the TS1108 should be short and symmetric. Also recommended are surface mount resistors and capacitors, as well as a ground plane.



### 3. Electrical Characteristics

**Table 3.1. Recommended Operating Conditions<sup>1</sup>**

Parameter	Symbol	Conditions	Min	Typ	Max	Units
<b>System Specifications</b>						
Operating Voltage Range	VDD		1.7	—	5.25	V
Common-Mode Input Range	V <sub>CM</sub>	V <sub>RS+</sub> , Guaranteed by CMRR	2	—	27	V
<b>Note:</b>						
1. All devices 100% production tested at T <sub>A</sub> = +25 °C. Limits over Temperature are guaranteed by design and characterization.						

**Table 3.2. DC Characteristics<sup>1</sup>**

Parameter	Symbol	Conditions	Min	Typ	Max	Units
<b>System Specifications</b>						
No Load Input Supply Current	I <sub>RS+</sub> + I <sub>RS-</sub>	See Note 2	—	0.68	1.2	μA
	I <sub>VDD</sub>		—	1.93	2.88	μA
<b>Current Sense Amplifier</b>						
Common Mode Rejection Ratio	CMRR	2 V < V <sub>RS+</sub> < 27 V	120	130	—	dB
Input Offset Voltage <sup>3</sup>	V <sub>OS</sub>	T <sub>A</sub> = +25 °C	—	±100	±150	μV
		-40 °C < T <sub>A</sub> < +85 °C	—	—	±200	μV
V <sub>OS</sub> Hysteresis <sup>4</sup>	V <sub>HYS</sub>	T <sub>A</sub> = +25 °C	—	10	—	μV
Gain	G	TS1108-20	—	20	—	V/V
		TS1108-200	—	200	—	V/V
Positive Gain Error <sup>5</sup>	GE+	T <sub>A</sub> = +25 °C	—	±0.1	±0.6	%
		-40 °C < T <sub>A</sub> < +85 °C	—	—	±1	%
Negative Gain Error <sup>5</sup>	GE-	T <sub>A</sub> = +25 °C	—	±0.6	±1	%
		-40 °C < T <sub>A</sub> < +85 °C	—	—	±1.4	%
Gain Match <sup>5</sup>	GM	T <sub>A</sub> = +25 °C	—	±0.6	±1	%
		-40 °C < T <sub>A</sub> < +85 °C	—	—	±1.4	%
Transfer Resistance	R <sub>OUT</sub>	From FILT to OUT	28	40	52	kΩ
<b>CSA Buffer</b>						
Input Bias Current	I <sub>Buffer_BIAS</sub>		—	—	0.5	nA
Input referred DC Offset	V <sub>Buffer_OS</sub>		—	—	±2.5	mV
Offset Drift	TCV <sub>Buffer_OS</sub>	-40 °C < T <sub>A</sub> < +85 °C	—	0.6	—	μV/°C
Input Common Mode Range	V <sub>Buffer_CM</sub>		0.2	—	VDD - 0.2	V
<b>CSA Sign Comparator</b>						

Parameter	Symbol	Conditions	Min	Typ	Max	Units
Output Low Voltage	$V_{SIGN\_OL}$	$V_{DD} = 1.7\text{ V}$ , $I_{SINK} = 35\ \mu\text{A}$	—	—	0.2	V
Output High Voltage	$V_{SIGN\_OH}$	$V_{DD} = 1.7\text{ V}$ , $I_{SOURCE} = 35\ \mu\text{A}$	$V_{DD} - 0.2$	—	—	V
<b>Comparator</b>						
Input Bias Current	$I_{CIN\_BIAS}$	CIN–	—	—	0.5	nA
Input Bias Current	$I_{CIN+\_BIAS}$	CIN+	—	0.3	—	nA
Input referred DC offset	$V_{C\_OS}$		—	—	$\pm 4$	mV
Input Common Mode Range	$V_{C\_CM}$		0.4	—	$V_{DD} - 0.4$	V
COOUT Output Range	$V_{COOUT(min,max)}$	$I_{COOUT} = \pm 500\ \mu\text{A}$ ; $V_{DD} = 1.7\text{ V}$	0.4	—	$V_{DD} - 0.4$	V
Output Range	$V_{OUT(min,max)}$	$I_{OUT} = \pm 150\ \mu\text{A}$ ; $V_{DD} = 1.7\text{ V}$	0.2	—	$V_{DD} - 0.2$	V
<b>Integrator</b>						
Input Referred DC Offset	$V_{INT\_OS}$		—	—	$\pm 2.5$	mV
Offset Drift	$TCV_{INT\_OS}$	$-40\text{ C} < T_A < +85\text{ C}$	—	0.6	—	$\mu\text{V/C}$
Input Common-Mode Range	$V_{INT\_CM}$		0.2	—	$V_{DD} - 0.2$	V
Output Low Voltage	$I_{INT\_OL}$	$I_{CIN+(SINK)} = 150\ \mu\text{A}$ ; $V_{DD} = 1.7\text{ V}$	—	—	0.2	V
Output High Voltage	$I_{INT\_OH}$	$I_{CIN+(SOURCE)} = 150\ \mu\text{A}$ ; $V_{DD} = 1.7\text{ V}$	$V_{DD} - 0.2$	—	—	V
<b>VREF Divider</b>						
VREF Activation voltage	$V_{REF(min)}$	VREF Rising edge	—	—	0.9	V
Resistor on VREF	$R_{VREF}$		—	4.6	—	M $\Omega$
VBIAS	$V_{VBIAS}$	$V_{REF} = 1\text{ V}$	0.495	0.5	0.505	V
CIN–	$V_{CIN-}$	$V_{REF} = 1\text{ V}$	0.895	0.9	0.505	V
<b>Note:</b>						
1. $RS+ = RS- = 3.6\text{ V}$ ; $V_{SENSE} = (V_{RS+} - V_{RS-}) = 0\text{ V}$ ; $V_{DD} = 3\text{ V}$ ; $V_{BIAS} = 1.5\text{ V}$ ; $CIN+ = 0.75\text{ V}$ ; $V_{REF} = \text{GND}$ ; $CLATCH = \text{GND}$ ; $R_{FET} = 1\text{ M}\Omega$ ; $FILT$ connected to $4\text{ k}\Omega$ and $470\text{ nF}$ in series to $\text{GND}$ . $T_A = T_J = -40\text{ }^\circ\text{C}$ to $+85\text{ }^\circ\text{C}$ unless otherwise noted. Typical values are at $T_A = +25\text{ }^\circ\text{C}$ .						
2. Extrapolated to $V_{OUT} = V_{FILT}$ ; $I_{RS+} + I_{RS-}$ is the total current into the $RS+$ and the $RS-$ pins.						
3. Input offset voltage $V_{OS}$ is extrapolated from a $V_{OUT(+)}$ measurement with $V_{SENSE}$ set to $+1\text{ mV}$ and a $V_{OUT(-)}$ measurement with $V_{SENSE}$ set to $-1\text{ mV}$ ; average $V_{OS} = (V_{OUT(-)} - V_{OUT(+)}) / (2 \times \text{GAIN})$ .						
4. Amplitude of $V_{SENSE}$ lower or higher than $V_{OS}$ required to cause the comparator to switch output states.						
5. Gain error is calculated by applying two values for $V_{SENSE}$ and then calculating the error of the actual slope vs. the ideal transfer characteristic. For $\text{GAIN} = 20\text{ V/V}$ , the applied $V_{SENSE}$ for $GE_{\pm}$ is $\pm 25\text{ mV}$ and $\pm 60\text{ mV}$ . For $\text{GAIN} = 200\text{ V/V}$ , the applied $V_{SENSE}$ for $GE_{\pm}$ is $\pm 2.5\text{ mV}$ and $\pm 6\text{ mV}$ .						

**Table 3.3. AC Characteristics**

Parameter	Symbol	Conditions	Min	Typ	Max	Units
<b>CSA Buffer</b>						
Output Settling time	$t_{OUT\_s}$	1% Final value, $V_{OUT} = 1.3\text{ V}$	—	1.35	—	msec
<b>Sign Comparator Parameters</b>						
Propagation Delay	$t_{SIGN\_PD}$	$V_{SENSE} = \pm 1\text{ mV}$	—	3	—	msec
		$V_{SENSE} = \pm 10\text{ mV}$	—	0.4	—	msec
<b>Reset Switch</b>						
Capacitor Discharge Time	$t_{RESET}$	$C_{INT} = 0.1\ \mu\text{F}$ ; After comparator trigger	—	—	60	$\mu\text{sec}$
<b>Comparator</b>						
Rising Propagation Delay	$t_{C\_PDR}$	Overdrive = +10 mV, $C_{COUT} = 15\text{ pF}$	—	9	—	$\mu\text{sec}$
Comparator Hysteresis	$V_{C\_HYS}$	CIN+ Rising	—	20	—	mV
<b>Monoshot</b>						
Monoshot Time	$t_{MONO}$	$1.7 \leq V_{DD} \leq 5.25$	75.5	90	126	$\mu\text{sec}$

**Table 3.4. Thermal Conditions**

Parameter	Symbol	Conditions	Min	Typ	Max	Units
Operating Temperature Range	$T_{OP}$		-40	—	+85	$^{\circ}\text{C}$

**Table 3.5. Absolute Maximum Limits**

Parameter	Symbol	Conditions	Min	Typ	Max	Units
RS+ Voltage	$V_{RS+}$		-0.3	—	27	V
RS- Voltage	$V_{RS-}$		-0.3	—	27	V
Supply Voltage	VDD		-0.3	—	6	V
OUT Voltage	$V_{OUT}$		-0.3	—	6	V
SIGN Voltage	$V_{SIGN}$		-0.3	—	6	V
FILT Voltage	$V_{FILT}$		-0.3	—	6	V
SW_RST Voltage	$V_{SW\_RST}$		-0.3	—	6	V
COUT Voltage	$V_{COUT}$		-0.3	—	6	V
VREF Voltage	$V_{VREF}$		-0.3	—	6	V
CIN+ Voltage	$V_{CIN+}$		-0.3	—	VDD + 0.3	V
CIN- Voltage	$V_{CIN-}$		-0.3	—	VDD + 0.3	V
INT- Voltage	$V_{INT-}$		-0.3	—	VDD + 0.3	V
VBIAS Voltage	$V_{VBIAS}$		-0.3	—	VDD + 0.3	V
RS+ to RS- Voltage	$V_{RS+} - V_{RS-}$		—	—	27	V
Short Circuit Duration: OUT to GND			—	—	Continuous	
Continuous Input Current (Any Pin)			-20	—	20	mA
Junction Temperature			—	—	150	°C
Storage Temperature Range			-65	—	150	°C
Lead Temperature (Soldering, 10 s)			—	—	300	°C
Soldering Temperature (Reflow)			—	—	260	°C
<b>ESD Tolerance</b>						
Human Body Model			—	—	2000	V
Machine Model			—	—	200	V

For the following graphs,  $V_{RS+} = V_{RS-} = 3.6\text{ V}$ ;  $V_{DD} = 3\text{ V}$ ;  $V_{REF} = \text{GND}$ ;  $V_{BIAS} = 1.5\text{ V}$ ,  $C_{IN-} = 2.5\text{ nF}$ ,  $SW\_RST = \text{COUT}$ ;  $R_{INT} = 47\text{ k}\Omega$ ;  $C_{INT} = 0.1\text{ }\mu\text{F}$ , and  $T_A = +25\text{ }^\circ\text{C}$  unless otherwise noted.

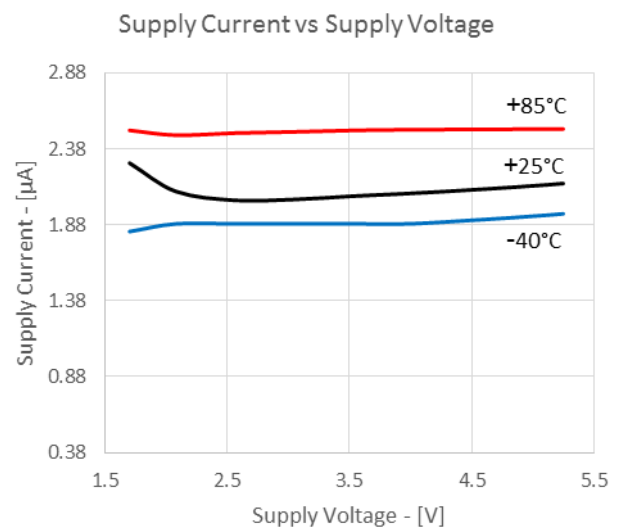
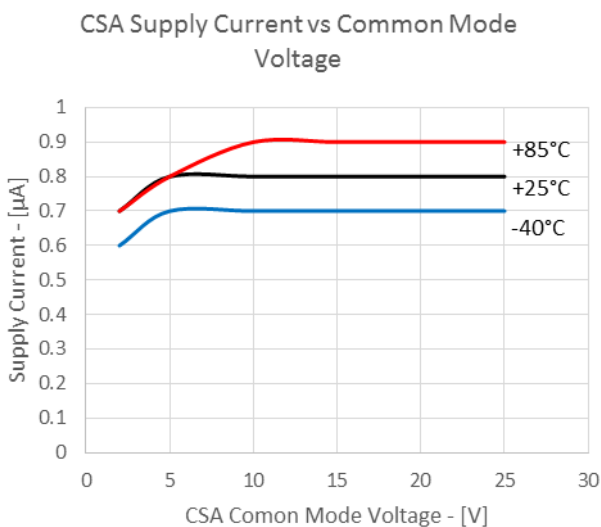
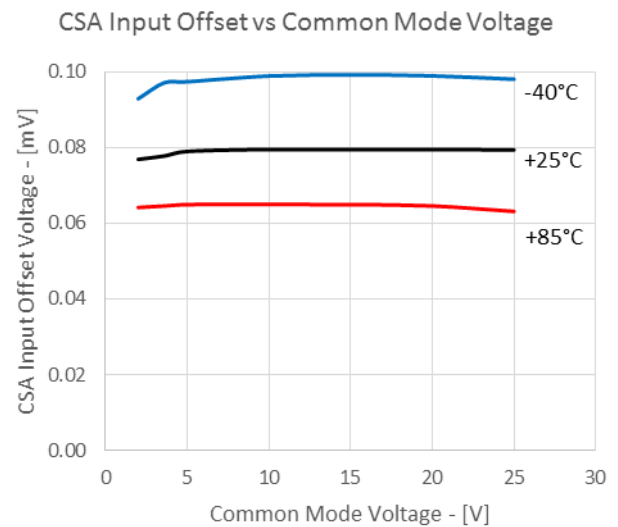
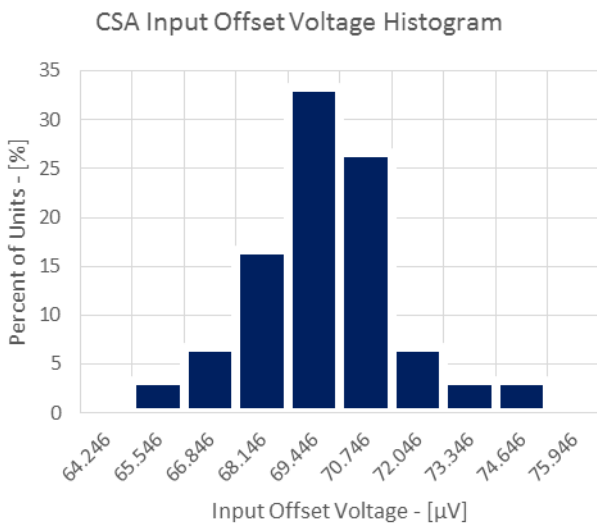
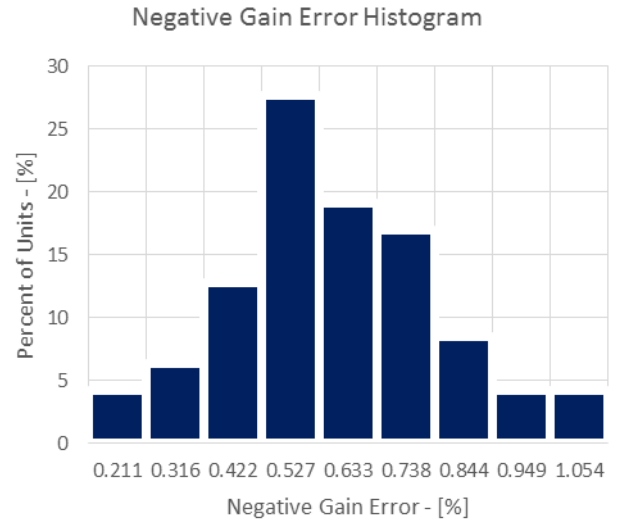
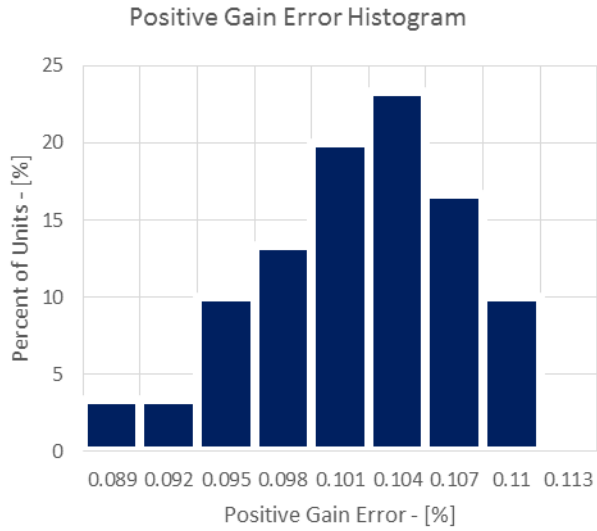

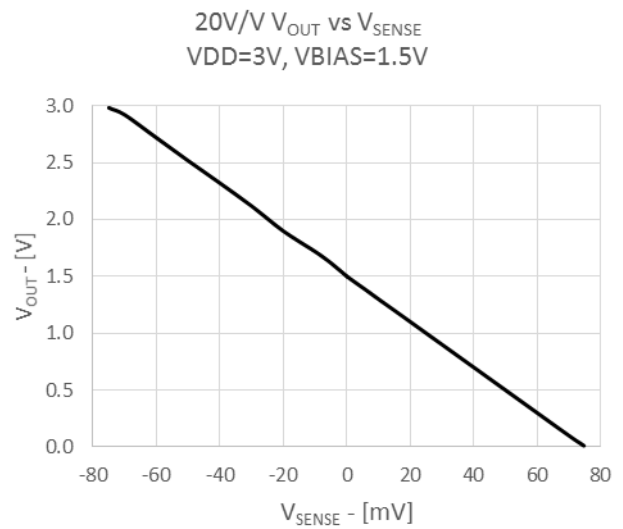
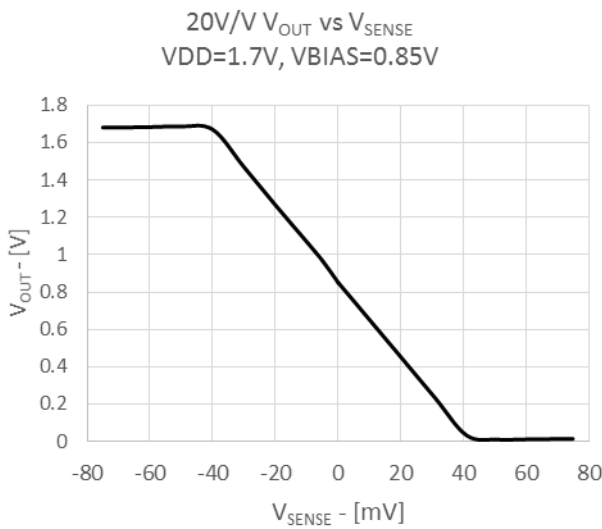
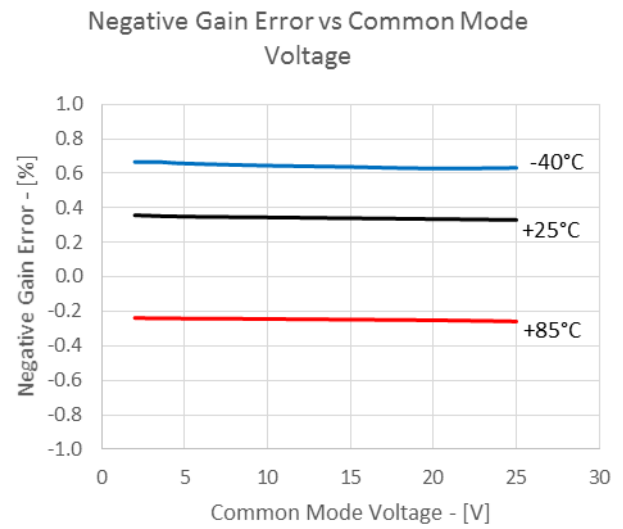
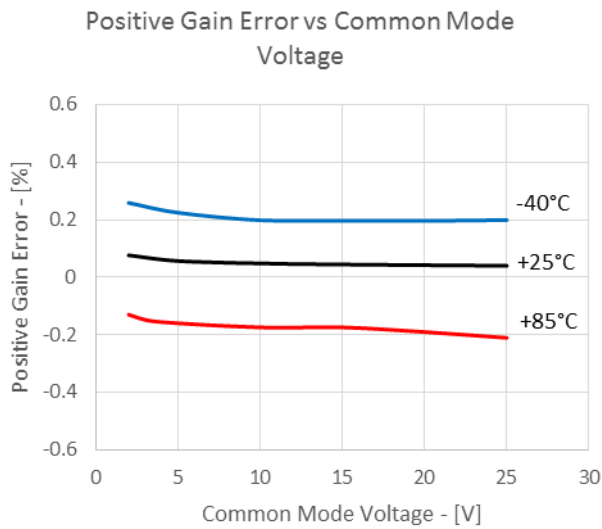
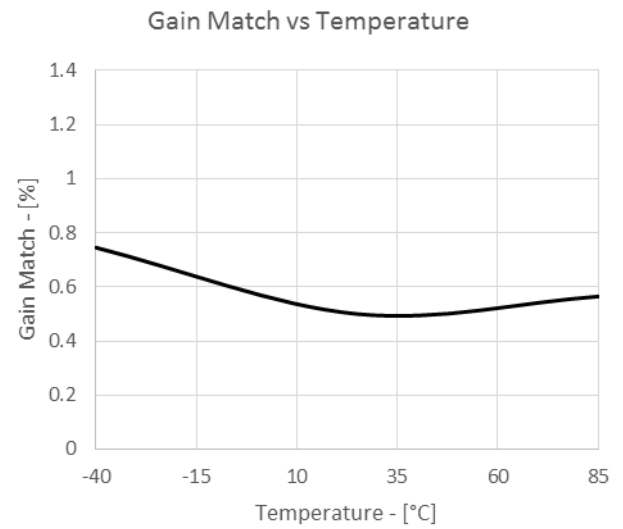
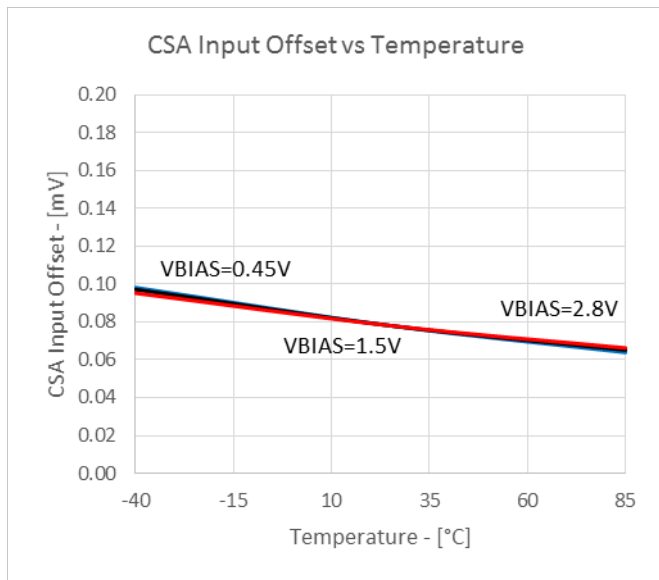

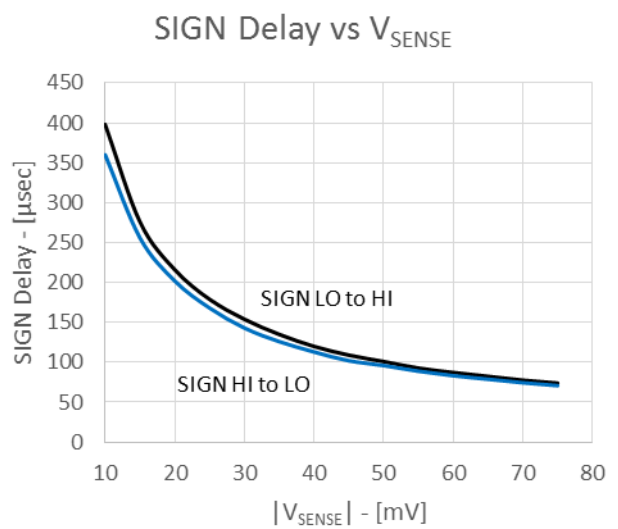
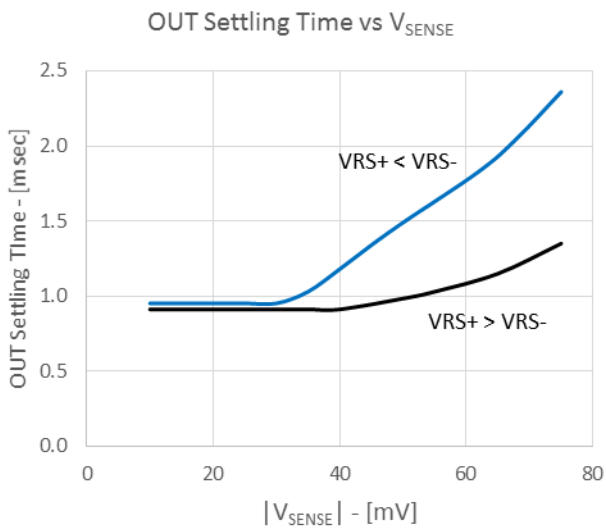
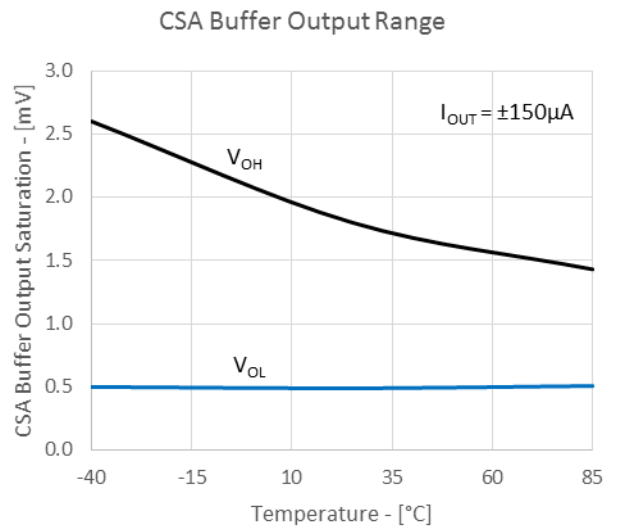
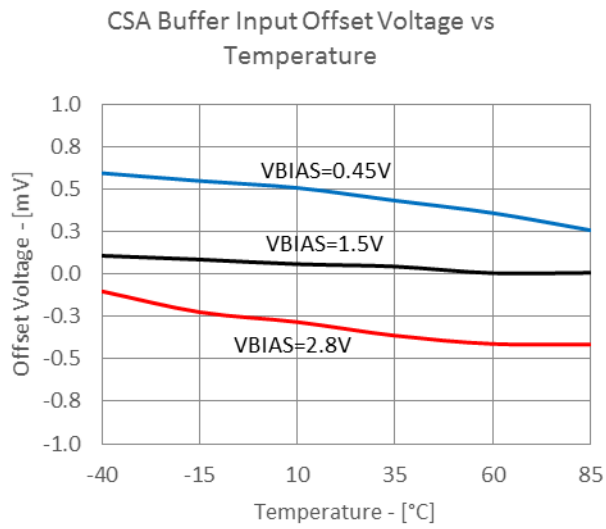
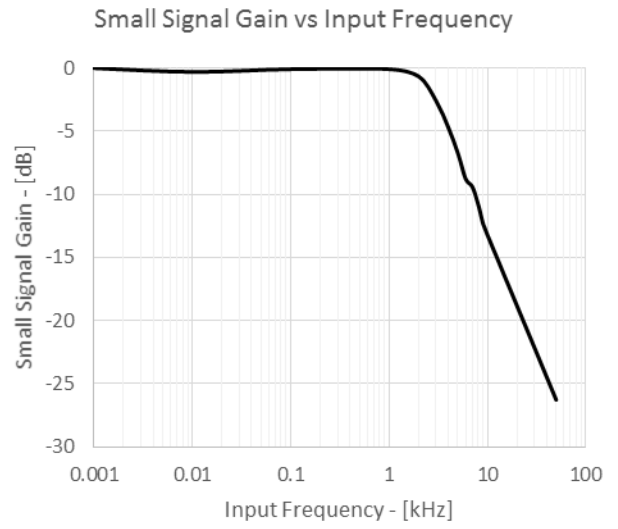
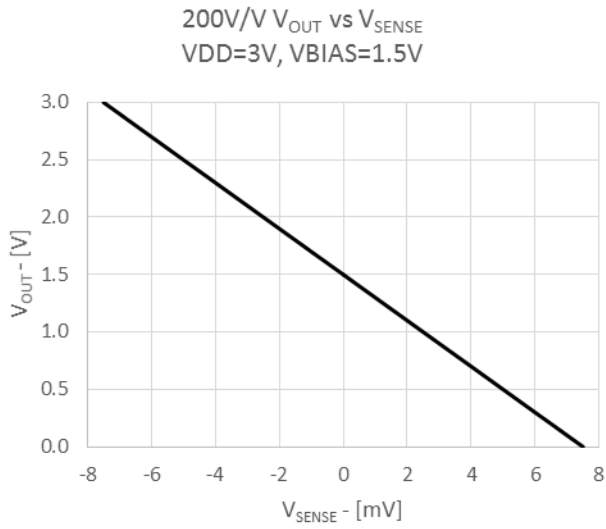

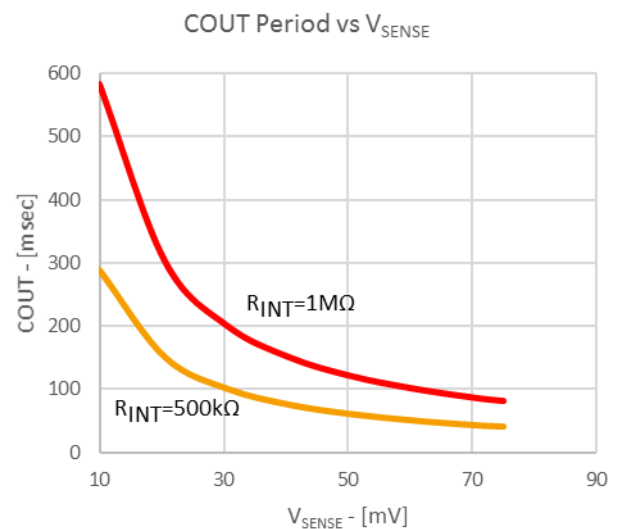
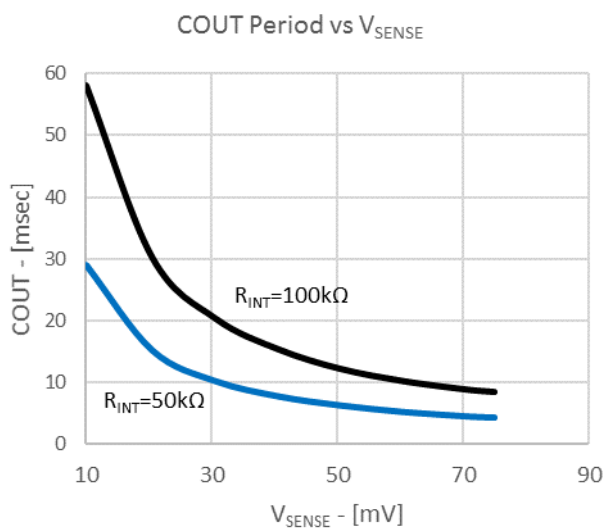
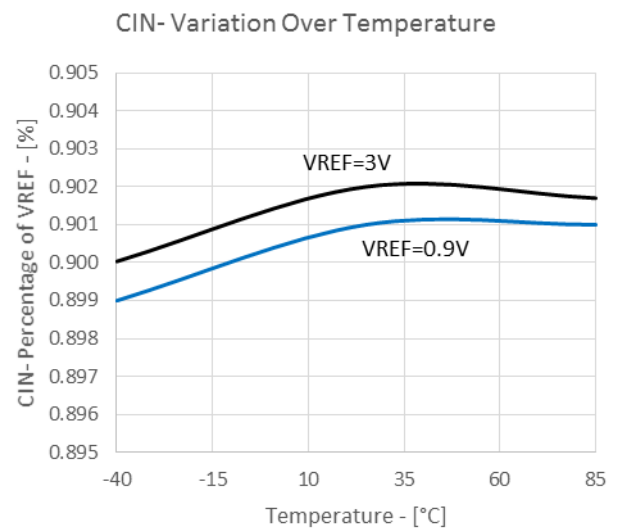
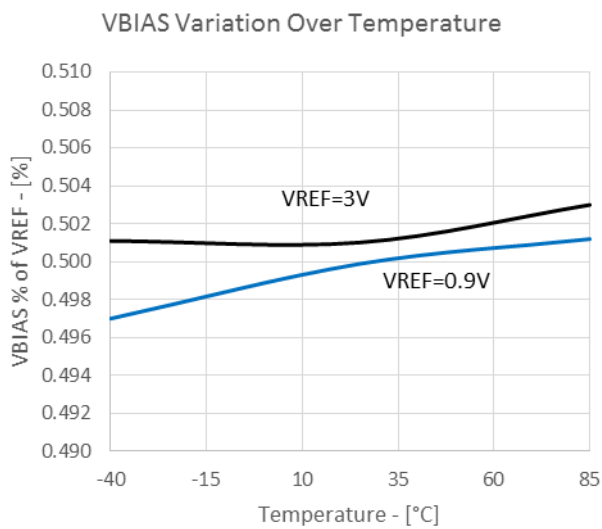
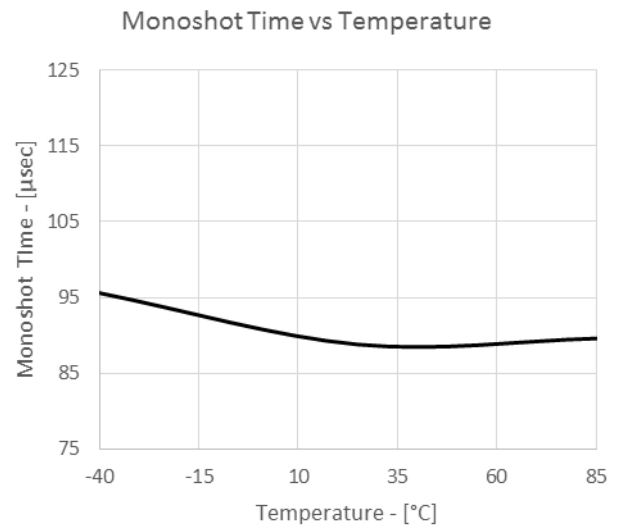
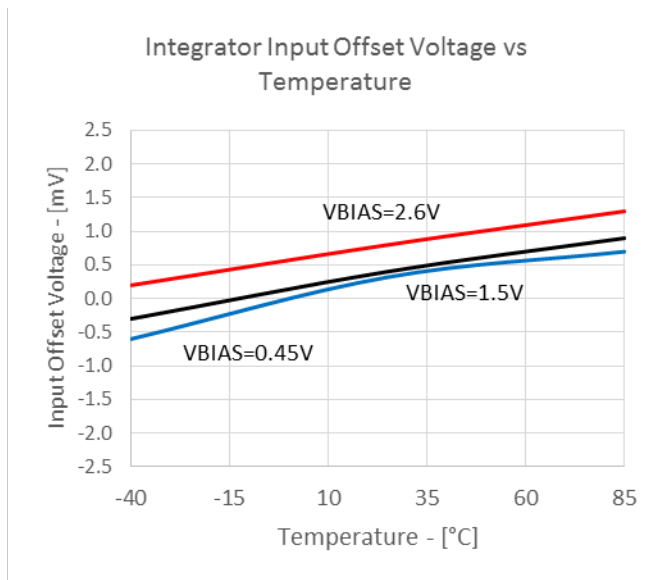



Small Signal Pulse Response  
TS1108-20

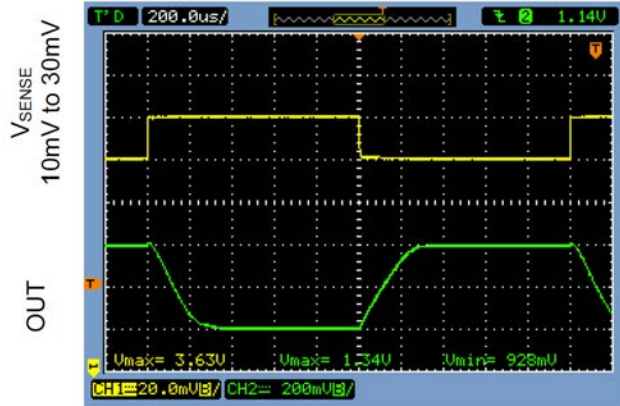

Large Signal Pulse Response  
TS1108-20

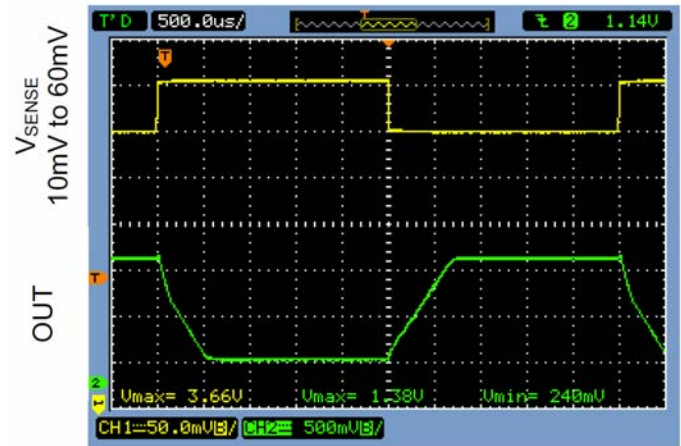

TS1108-20 Coulomb Counting  
 $V_{SENSE}=10mV$ ,  $V_{BIAS}=1.5V$ ,  $V_{CIN-}=2.5V$

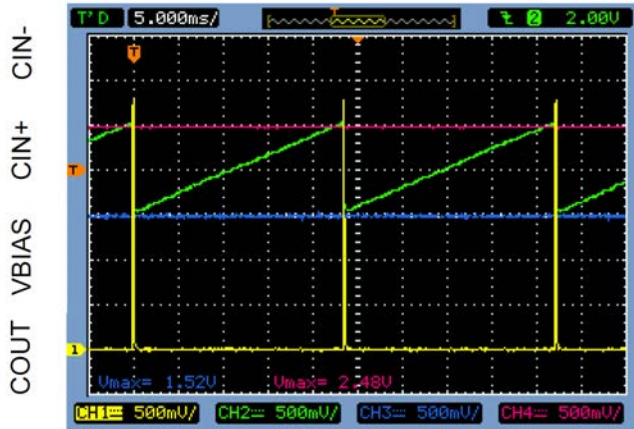

TS1108-20 Coulomb Counting  
 $V_{BIAS}=1.5V$ ,  $V_{CIN-}=2.5V$

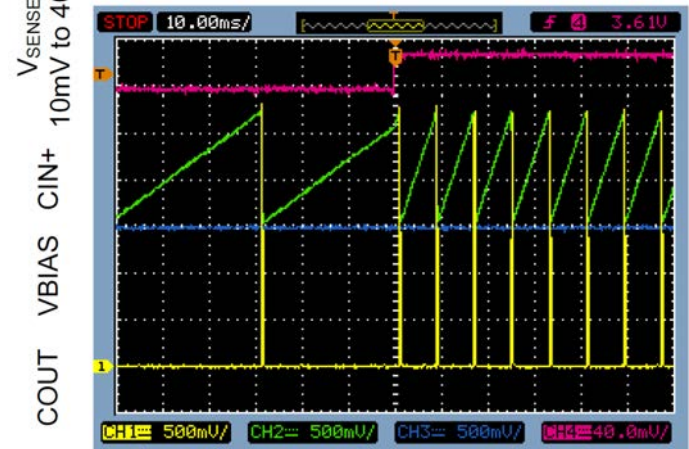

### 4. Typical Application Circuit

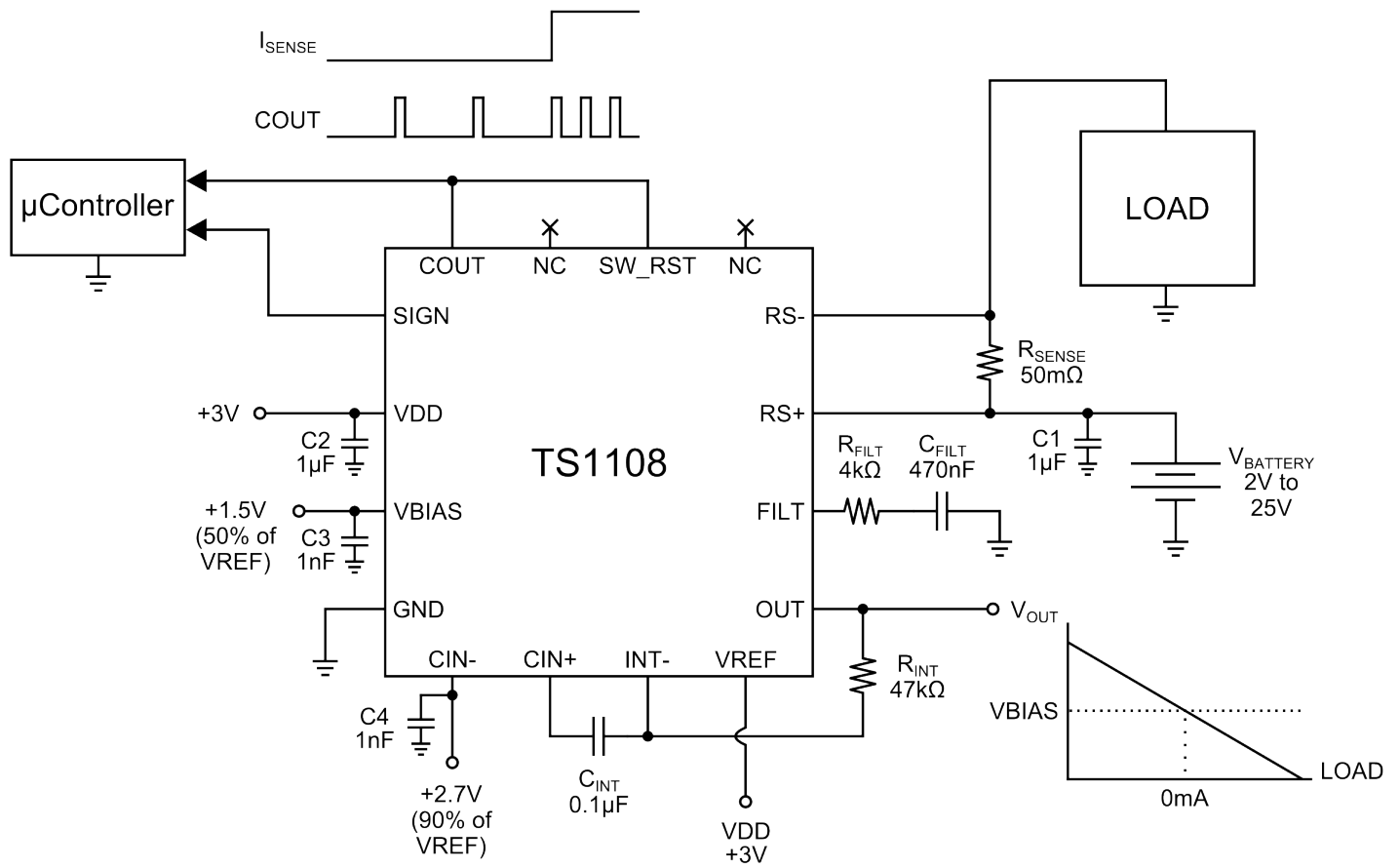
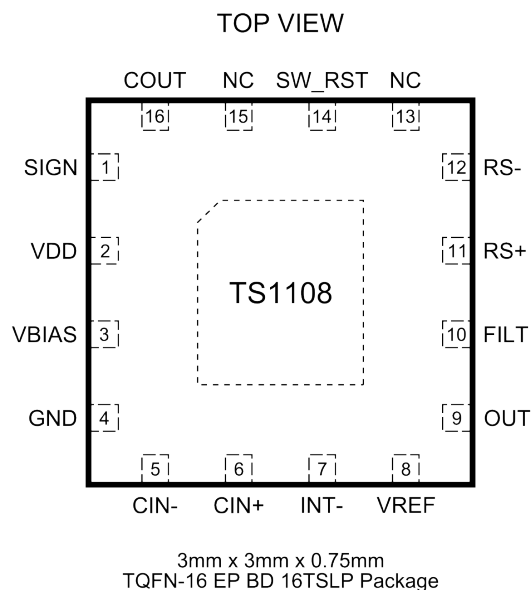

Figure 4.1. TS1108 Typical Application Circuit

## 5. Pin Descriptions



**Figure 5.1. TS1108 Pinout**

**Table 5.1. Pin Descriptions**

Pin	Label	Function
1	SIGN	Sign output. SIGN is HIGH for $V_{RS+} > V_{RS-}$ and LOW for $V_{RS-} > V_{RS+}$ .
2	VDD	External power supply pin. Connect this to the system's VDD supply.
3	VBIAS	Bias voltage for CSA output. When VREF is activated, leave open.
4	GND	Ground. Connect to analog ground.
5	CIN-	Inverting terminal of Comparator. Supply a reference voltage for integration limit. CIN- voltage must be greater than VBIAS. If VREF is activated, leave open.
6	CIN+	Integrator Output and Non-inverting terminal of Comparator. Connect $C_{INT}$ in series from INT-.
7	INT-	Inverting Terminal of Integrator. Connect $R_{INT}$ in series from OUT. Connect $C_{INT}$ in series to CIN+.
8	VREF	Voltage reference. To activate, a minimum voltage of 0.9 V is required. To disable voltage divider, connect to analog ground, GND.
9	OUT	CSA buffered output. Connect $R_{INT}$ in series to INT-.
10	FILT	Inverting terminal of CSA Buffer. Connect a series RC Filter of 4 k $\Omega$ and 0.47 $\mu$ F, otherwise leave open.
11	RS+	External Sense Resistor Power-Side Connection
12	RS-	External Sense Resistor Load-Side Connection. Connect external PFET's source.
13	NC	No connection. Leave open.
14	SW_RST	Integrator Reset Switch control. To enable coulomb counting, connect SW_RST to GND or COUT. Hold SW_RST HIGH to short CIN+ and INT-.
15	NC	No connection. Leave open.
16	COUT	Coulomb Comparator Counter Output.
Exposed Pad	EPAD	Exposed backside paddle. For best electrical and thermal performance, solder to analog ground.

## 6. Packaging

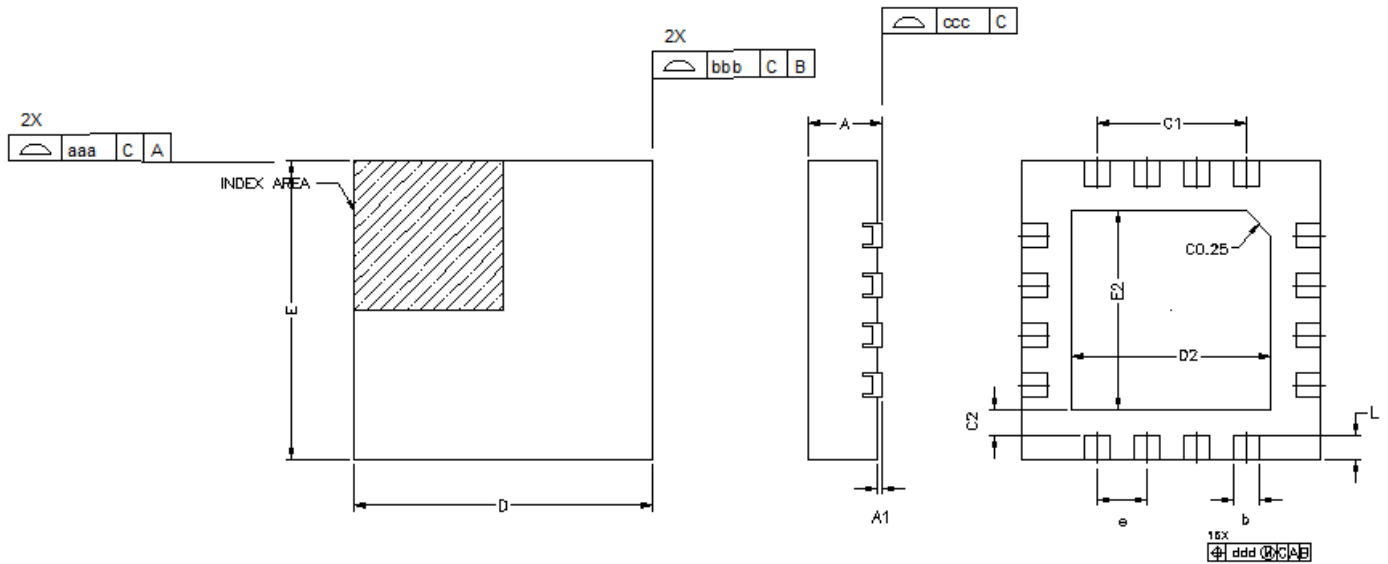

Figure 6.1. TS1108 3x3 mm 16-QFN Package Diagram

Table 6.1. Package Dimensions

Dimension	Min	Nom	Max
A	0.70	0.75	0.80
A1	0.00	0.02	0.05
b	0.20	0.25	0.30
C1	1.50 REF		
C2	0.25 REF		
D	3.00 BSC		
D2	1.90	2.00	2.10
e	0.50 BSC		
E	3.00 BSC		
E2	1.90	2.00	2.10
L	0.20	0.25	0.30
aaa	—	—	0.05
bbb	—	—	0.05
ccc	—	—	0.05
ddd	—	—	0.10

**Note:**

1. All dimensions shown are in millimeters (mm) unless otherwise noted.
2. Dimensioning and Tolerancing per ANSI Y14.5M-1994.

## 7. Top Marking

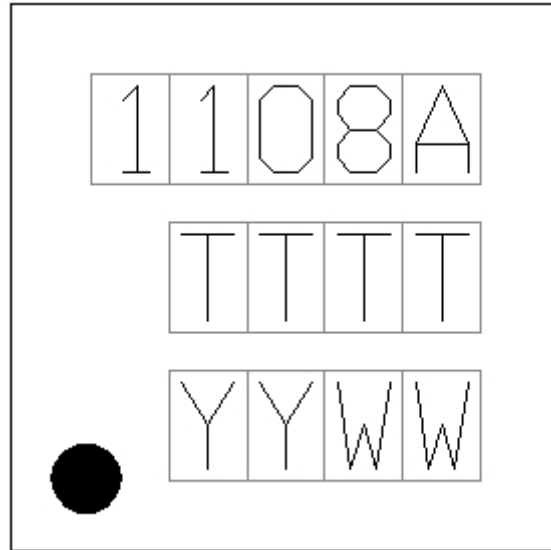

**Figure 7.1. Top Marking**

**Table 7.1. Top Marking Explanation**

Mark Method	Laser	
Pin 1 Mark:	Circle = 0.50 mm Diameter (lower left corner)	
Font Size:	0.50 mm (20 mils)	
Line 1 Mark Format:	Product ID	Note: A = 20 gain, B = 200 gain
Line 2 Mark Format:	TTTT – Mfg Code	Manufacturing code
Line 3 Mark Format:	YY = Year; WW = Work Week	Year and week of assembly

## 8. Document Change List

### Revision 1.0 to Revision 1.1

- Updated [1. Ordering Information](#) with correct part numbers.

---

# Table of Contents

<b>1. Ordering Information</b>	<b>1</b>
<b>2. System Overview</b>	<b>2</b>
2.1 Functional Block Diagram	2
2.2 Current Sense Amplifier + Output Buffer	3
2.3 Sign Output	4
2.4 Integrator + Comparator	4
2.5 VREF Divider	4
2.6 Coulomb Counter	5
2.7 Selecting a Sense Resistor	5
2.7.1 RSENSE Voltage Loss	5
2.7.2 VOUT Swing vs. Desired VSENSE and Applied Supply Voltage at VDD.	5
2.7.3 Total Load Current Accuracy	6
2.7.4 Circuit Efficiency and Power Dissipation	6
2.7.5 RSENSE Kelvin Connections	6
2.7.6 RSENSE Composition	6
2.7.7 Internal Noise Filter	6
2.7.8 PC Board Layout and Power-Supply Bypassing	7
<b>3. Electrical Characteristics</b>	<b>8</b>
<b>4. Typical Application Circuit</b>	<b>17</b>
<b>5. Pin Descriptions</b>	<b>18</b>
<b>6. Packaging</b>	<b>19</b>
<b>7. Top Marking</b>	<b>20</b>
<b>8. Document Change List</b>	<b>21</b>

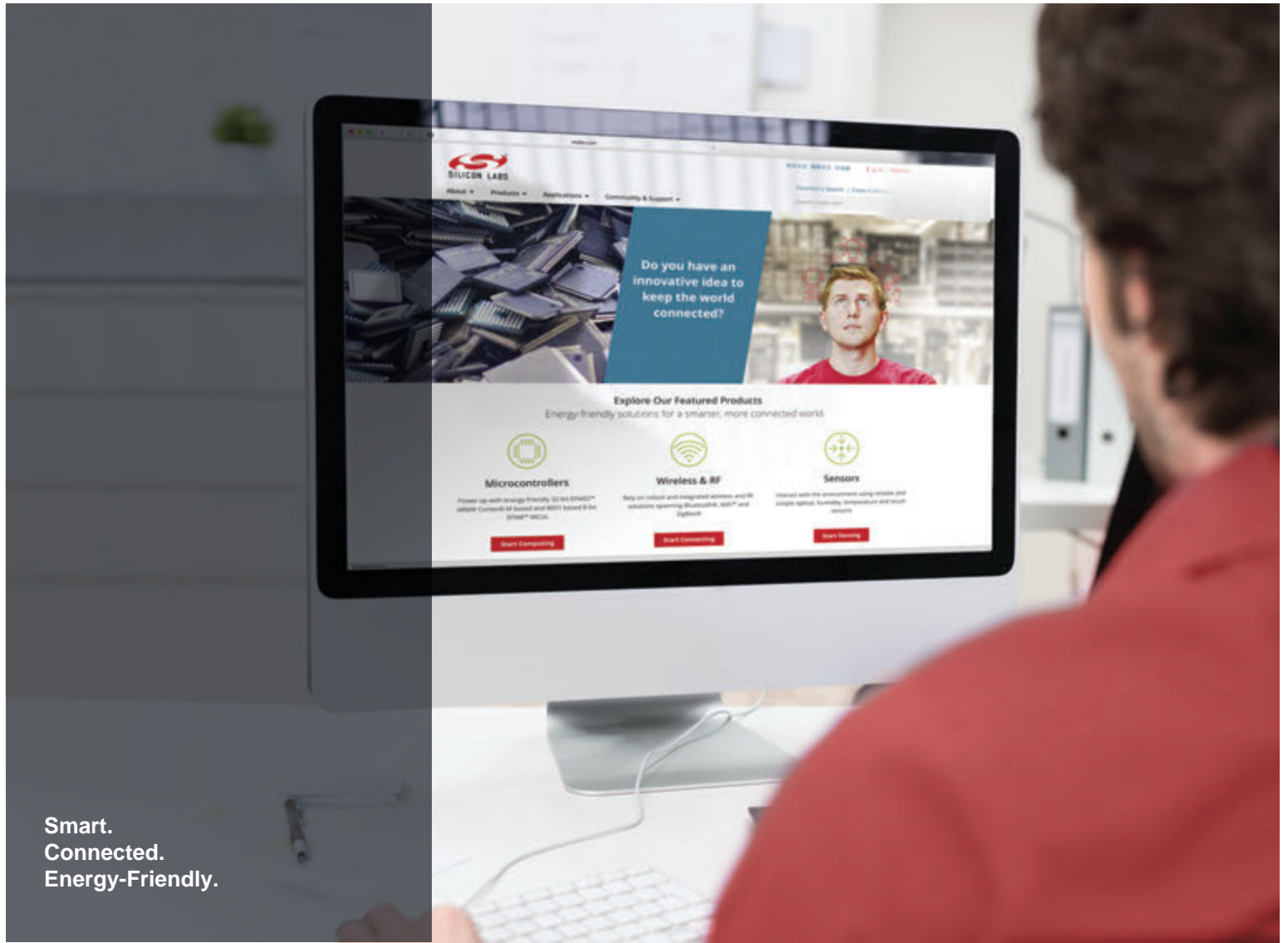

Smart.  
Connected.  
Energy-Friendly.



**Products**  
[www.silabs.com/products](http://www.silabs.com/products)

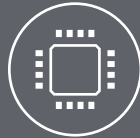

**Quality**  
[www.silabs.com/quality](http://www.silabs.com/quality)



**Support and Community**  
[community.silabs.com](http://community.silabs.com)

**Disclaimer**

Silicon Labs intends to provide customers with the latest, accurate, and in-depth documentation of all peripherals and modules available for system and software implementers using or intending to use the Silicon Labs products. Characterization data, available modules and peripherals, memory sizes and memory addresses refer to each specific device, and "Typical" parameters provided can and do vary in different applications. Application examples described herein are for illustrative purposes only. Silicon Labs reserves the right to make changes without further notice and limitation to product information, specifications, and descriptions herein, and does not give warranties as to the accuracy or completeness of the included information. Silicon Labs shall have no liability for the consequences of use of the information supplied herein. This document does not imply or express copyright licenses granted hereunder to design or fabricate any integrated circuits. The products are not designed or authorized to be used within any Life Support System without the specific written consent of Silicon Labs. A "Life Support System" is any product or system intended to support or sustain life and/or health, which, if it fails, can be reasonably expected to result in significant personal injury or death. Silicon Labs products are not designed or authorized for military applications. Silicon Labs products shall under no circumstances be used in weapons of mass destruction including (but not limited to) nuclear, biological or chemical weapons, or missiles capable of delivering such weapons.

**Trademark Information**

Silicon Laboratories Inc.®, Silicon Laboratories®, Silicon Labs®, SiLabs® and the Silicon Labs logo®, Bluegiga®, Bluegiga Logo®, Clockbuilder®, CMEMS®, DSPLL®, EFM®, EFM32®, EFR, Ember®, Energy Micro, Energy Micro logo and combinations thereof, "the world's most energy friendly microcontrollers", Ember®, EZLink®, EZRadio®, EZRadioPRO®, Gecko®, ISOModem®, Precision32®, ProSLIC®, Simplicity Studio®, SiPHY®, Telegesis, the Telegesis Logo®, USBXpress® and others are trademarks or registered trademarks of Silicon Labs. ARM, CORTEX, Cortex-M3 and THUMB are trademarks or registered trademarks of ARM Holdings. Keil is a registered trademark of ARM Limited. All other products or brand names mentioned herein are trademarks of their respective holders.



Silicon Laboratories Inc.  
400 West Cesar Chavez  
Austin, TX 78701  
USA

<http://www.silabs.com>