

**TO-92**

**Pin Definition:**

1. Emitter
2. Collector
3. Base

**PRODUCT SUMMARY**

<b><math>BV_{CEO}</math></b>	400V
<b><math>BV_{CBO}</math></b>	700V
<b><math>I_C</math></b>	0.2A
<b><math>V_{CE(SAT)}</math></b>	0.5V @ $I_C / I_B = 100mA / 10mA$

**Features**

- High Voltage
- High Speed Switching

**Structure**

- Silicon Triple Diffused Type
- NPN Silicon Transistor

**Ordering Information**

Part No.	Package	Packing
TS13002CT B0	TO-92	1Kpcs / Bulk
TS13002CT B0G	TO-92	1Kpcs / Bulk
TS13002CT A3	TO-92	2Kpcs / Ammo
TS13002CT A3G	TO-92	2Kpcs / Ammo

Note: "G" denote for Green Product

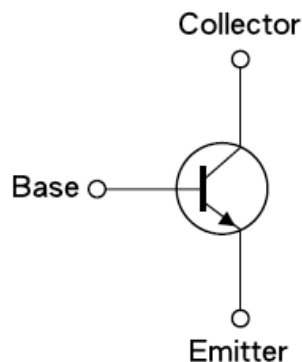
**Block Diagram**

**Absolute Maximum Rating** ( $T_a = 25^{\circ}C$  unless otherwise noted)

Parameter	Symbol	Limit	Unit
Collector-Base Voltage	$V_{CBO}$	700V	V
Collector-Emitter Voltage	$V_{CEO}$	400V	V
Emitter-Base Voltage	$V_{EBO}$	9	V
Collector Current	$I_C$	DC	0.2
		Pulse	0.5
Collector Power Dissipation	$P_D$	0.6	W
Operating Junction Temperature	$T_J$	+150	$^{\circ}C$
Operating Junction and Storage Temperature Range	$T_{STG}$	- 55 to +150	$^{\circ}C$

**Thermal Performance**

Parameter	Symbol	Limit	Unit
Junction to Ambient Thermal Resistance	$R_{\theta JA}$	122	$^{\circ}C/W$

**Electrical Specifications** (Ta = 25°C unless otherwise noted)

Parameter	Conditions	Symbol	Min	Typ	Max	Unit
<b>Static</b>						
Collector-Base Voltage	$I_C = 1\text{mA}, I_B = 0$	$BV_{CBO}$	700	--	--	V
Collector-Emitter Breakdown Voltage	$I_C = 10\text{mA}, I_E = 0$	$BV_{CEO}$	400	--	--	V
Emitter-Base Breakdown Voltage	$I_E = 1\text{mA}, I_C = 0$	$BV_{EBO}$	9	--	--	V
Collector Cutoff Current	$V_{CB} = 700\text{V}, I_E = 0$	$I_{CBO}$	--	--	1	uA
Emitter Cutoff Current	$V_{EB} = 7\text{V}, I_C = 0$	$I_{EBO}$	--	--	1	uA
Collector-Emitter Saturation Voltage	$I_C / I_B = 50\text{mA} / 10\text{mA}$	$V_{CE(SAT)1}$	--	0.2	0.4	V
	$I_C / I_B = 100\text{mA} / 10\text{mA}$	$V_{CE(SAT)2}$	--	0.45	1	
	$I_C / I_B = 200\text{mA} / 20\text{mA}$	$V_{CE(SAT)3}$	--	1	1.5	
Base-Emitter Saturation Voltage	$I_C / I_B = 50\text{mA} / 10\text{mA}$	$V_{BE(SAT)1}$	--	--	1	V
	$I_C / I_B = 100\text{mA} / 10\text{mA}$	$V_{BE(SAT)2}$	--	--	1.2	
DC Current Gain	$V_{CE} = 10\text{V}, I_C = 10\text{mA}$	$h_{FE1}$	10	--	40	
	$V_{CE} = 10\text{V}, I_C = 100\text{mA}$	$h_{FE2}$	20	--	40	
	$V_{CE} = 10\text{V}, I_C = 200\text{mA}$	$h_{FE3}$	10	--	40	
<b>Dynamic</b>						
Frequency	$V_{CE} = 10\text{V}, I_C = 0.1\text{A}$	$f_T$	4	--	--	MHz
Output Capacitance	$V_{CB} = 10\text{V}, f = 0.1\text{MHz}$	$C_{ob}$	--	21	--	pF
<b>Resistive Load Switching Time (Ratings)</b>						
Rise Time	$V_{CC} = 125\text{V}, I_C = 100\text{mA},$ $I_{B1} = I_{B2} = 20\text{mA},$ $t_p = 25\text{uS}$ Duty Cycle $\leq 1\%$	$t_r$	--	1.1	--	uS
Storage Time		$t_{STG}$	--	2	4	uS
Fall Time		$t_f$	--	0.2	0.7	uS

Note : pulse test: pulse width  $\leq 5\text{mS}$ , duty cycle  $\leq 10\%$

**Electrical Characteristics Curve** (Ta = 25°C, unless otherwise noted)

**Figure 1. Static Characteristics**

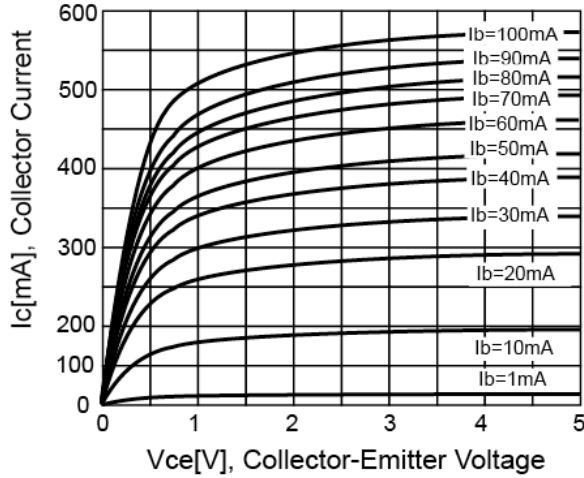

**Figure 2. DC Current Gain**

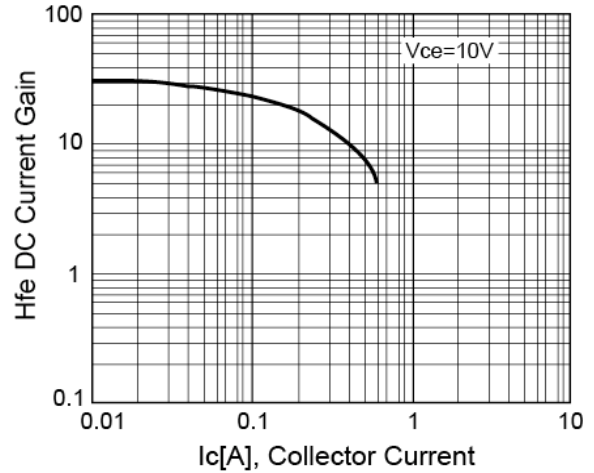

**Figure 3. Vce(sat) v.s. Vbe(sat)**

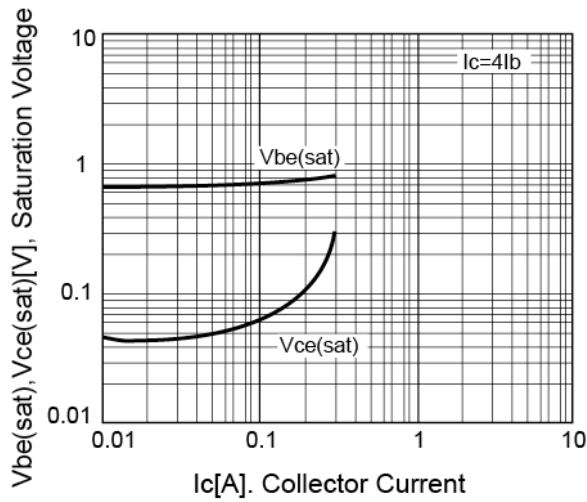

**Figure 4. Power Derating**

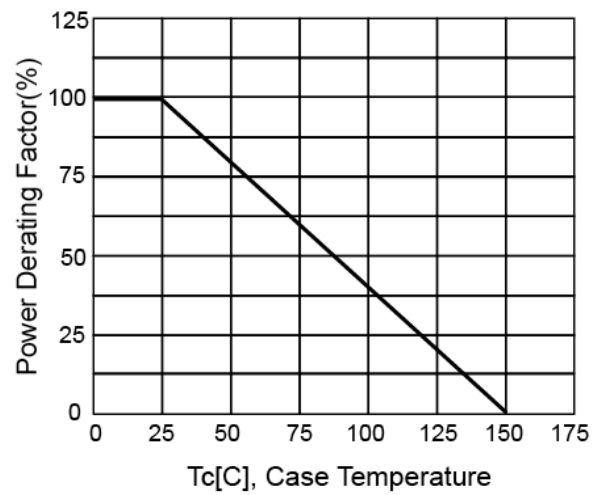

**Figure 5. Reverse Bias SOA**

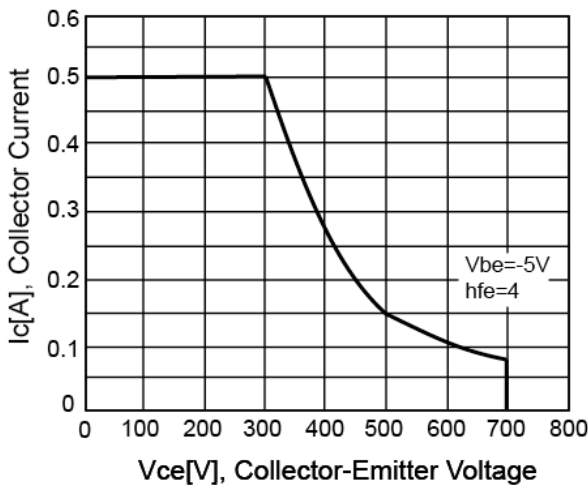

**Figure 6. Safety Operating Area**

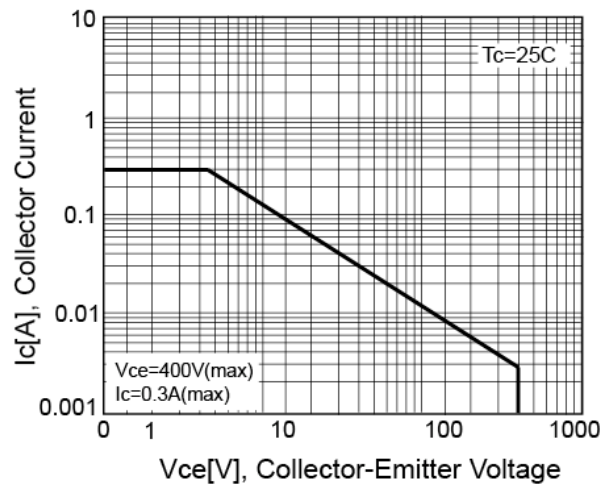

**TO-92 Mechanical Drawing**

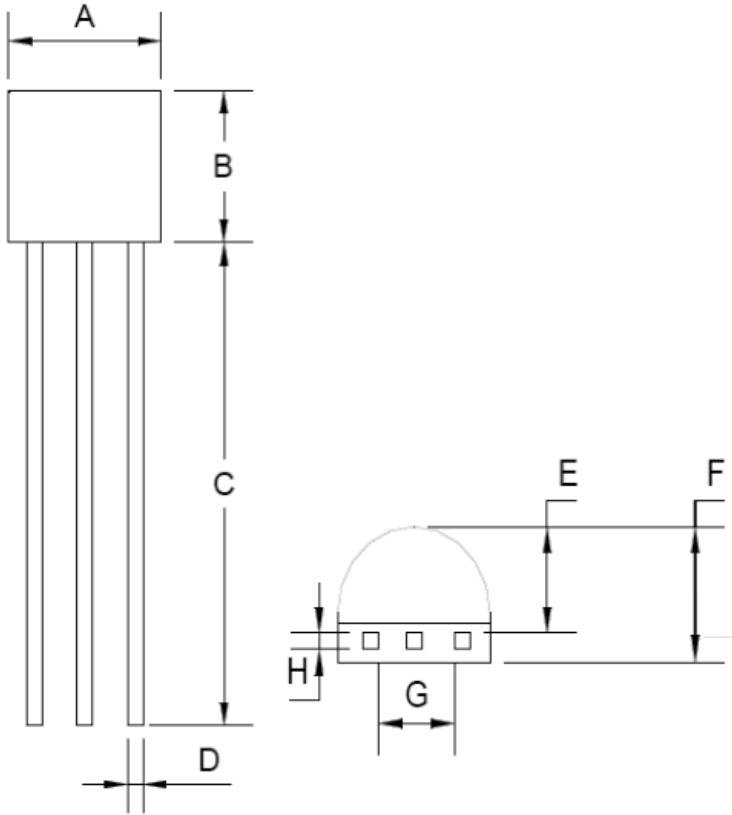

TO-92 DIMENSION				
DIM	MILLIMETERS		INCHES	
	MIN	MAX	MIN	MAX
A	4.30	4.70	0.169	0.185
B	4.30	4.70	0.169	0.185
C	14.30(typ)		0.563(typ)	
D	0.43	0.49	0.017	0.019
E	2.19	2.81	0.086	0.111
F	3.30	3.70	0.130	0.146
G	2.42	2.66	0.095	0.105
H	0.37	0.43	0.015	0.017

**Marking Diagram**

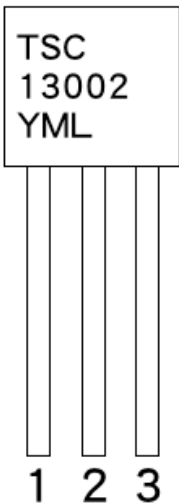

- Y** = Year Code
- M** = Month Code  
(A=Jan, B=Feb, C=Mar, D=Apl, E=May, F=Jun, G=Jul, H=Aug, I=Sep, J=Oct, K=Nov, L=Dec)
- L** = Lot Code

### Notice

Specifications of the products displayed herein are subject to change without notice. TSC or anyone on its behalf, assumes no responsibility or liability for any errors or inaccuracies.

Information contained herein is intended to provide a product description only. No license, express or implied, to any intellectual property rights is granted by this document. Except as provided in TSC's terms and conditions of sale for such products, TSC assumes no liability whatsoever, and disclaims any express or implied warranty, relating to sale and/or use of TSC products including liability or warranties relating to fitness for a particular purpose, merchantability, or infringement of any patent, copyright, or other intellectual property right.

The products shown herein are not designed for use in medical, life-saving, or life-sustaining applications. Customers using or selling these products for use in such applications do so at their own risk and agree to fully indemnify TSC for any damages resulting from such improper use or sale.