

SOP-8EP

Pin Definition:

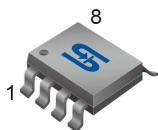

- | | |
|--------|---------|
| 1. BS | 8. SS |
| 2. VIN | 7. EN |
| 3. SW | 6. COMP |
| 4. GND | 5. FB |

General Description

The TS3553 is a synchronous step-down DC/DC converter that provides wide 4.5V to 23V input voltage range and 3A continuous load current capability. Fault protection includes cycle-by-cycle current limit, input UVLO, output over voltage protection and thermal shutdown. Besides, adjustable soft-start function prevents inrush current at turn-on. This device uses current mode control scheme that provides fast transient response. In shutdown mode, the regulator draws 1μA or less of supply current.

Features

- Operating Voltage Range 4.75V~23V
- Output load current up to 3A
- High Efficiency: Up to 95%
- Fixed Switching Frequency 350kHz
- 100mΩ Internal Power MOSFET
- Adjustable Output Voltage from 0.925~20V
- Stable with Low ESR Output Ceramic Capacitors
- Current Mode Operation
- Input Under Voltage Lockout
- Over Temperature Protection
- Cycle-by Cycle Current limit
- <1μA Shutdown Current

Ordering Information

Part No.	Package	Packing
TS3553CS RLG	SOP-8EP	2.5Kpcs / 13" Reel

Note: "G" denote for Halogen Free Product

Application

- Set-Top-Box
- DVD, LCD Displays
- Netbook
- Distributed Power System
- DSL Modems

Typical Application Circuit

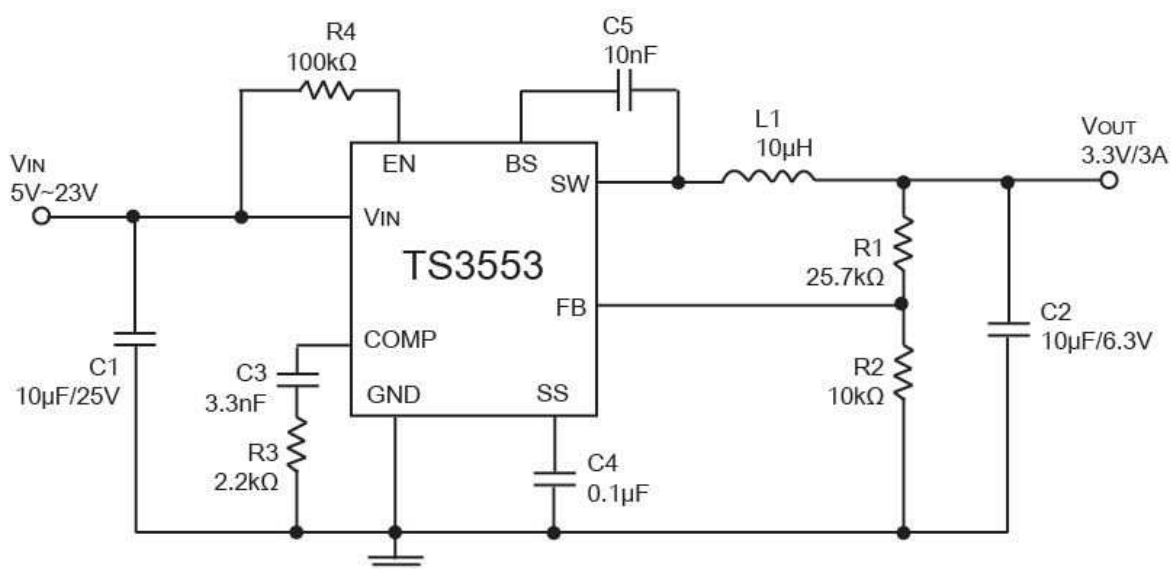

3.3V Output Application Circuit

Absolute Maximum Rating

Characteristics	Symbol	Rating	Unit
Maximum Supply Voltage	V_{IN}	-0.3 ~ +24	V
Switching Pin Input Voltage	V_{SW}	-1 ~ ($V_{IN} + 0.3$)	V
Boost Voltage	V_{BS}	($V_{SW} - 0.3$) ~ ($V_{SW} + 6$)	V
All Other Pins		-0.3 to +6	V
Output Voltage	V_{OUT}	0.925 ~ 20	V
Power Dissipation	P_D	Internal Limited	W
Operating Temperature Range	T_{OPR}	-40 to +85	°C
Storage Temperature Range	T_{ST}	-65 to +150	°C
Operating Junction Temperature Range	T_J	+150	°C
Thermal Resistance Junction to case	θ_{JC}	15	°C/W
Thermal Resistance Junction to ambient	θ_{JA}	40	°C/W

Note: Stresses exceed those rating may damage the device

Note: θ_{JA} is measured with the PCB copper area of approximately 1 in² (multi-layer)

Electrical Specifications ($T_A=25^\circ\text{C}$, $V_{IN}=12\text{V}$ unless otherwise noted)

Parameter	Symbol	Conditions	Min	Typ	Max	Unit
Operating Voltage	V_{IN}		4.75	--	23	V
Shutdown Supply Current	I_{SD}	$V_{EN}=0\text{V}$	--	1	3	μA
Feedback Voltage	V_{FB}	$4.75\text{V} \leq V_{IN} \leq 23\text{V}$	0.9	0.925	0.95	V
Load Regulation	REG_{LOAD}		-2	--	+2	%
High-Side MOSFET On-Resistance	R_{DSON}		--	100	--	m Ω
Low-Side MOSFET On-Resistance	R_{DSON}		--	100	--	m Ω
High-Side MOSFET Leakage Current	$I_{L(HIGH-SIDE)}$	$V_{EN} = 0\text{V}$, $V_{SW} = 0\text{V}$	--	--	10	μA
High-Side MOSFET Current Limit	I_{LIMIT}	Minimum Duty	3.8	--	--	A
Oscillator Frequency	F_{OSC}		280	350	430	KHz
Short Circuit Oscillator Frequency	F_{SC}	$V_{FB}=0\text{V}$	--	90	--	KHz
Maximum Duty Cycle	DC	$V_{FB}=0.8\text{V}$	--	90	--	%
Soft-Start Current	I_{SS}	$V_{SS}=0\text{V}$	--	6	--	μA
Soft-Start Period		$C_{SS}=0.1\mu\text{F}$	--	15	--	mS
EN Shutdown Threshold Voltage	V_{ENSD}	V_{EN} Rising	1.1	1.5	2.0	V
Thermal Shutdown	OTP		--	160	--	°C
Thermal Shutdown Hysteresis	$OTP_{HYSTERSIS}$		--	35	--	°C

Note 1: Specifications are production tested at $T_A=25^\circ\text{C}$. Specifications over the -40°C to 85°C operating temperature range are assured by design, characterization and correlation with Statistical Quality Controls (SQC).

Note 2: It is recommended to use duty ratio above 10% for minimizing resultant duty cycle jitter.

Note 3: It is recommended to connect a soft start capacitor to soft start pin. Leave the soft start pin open may cause large inrush current and output overshooting

Block Diagram

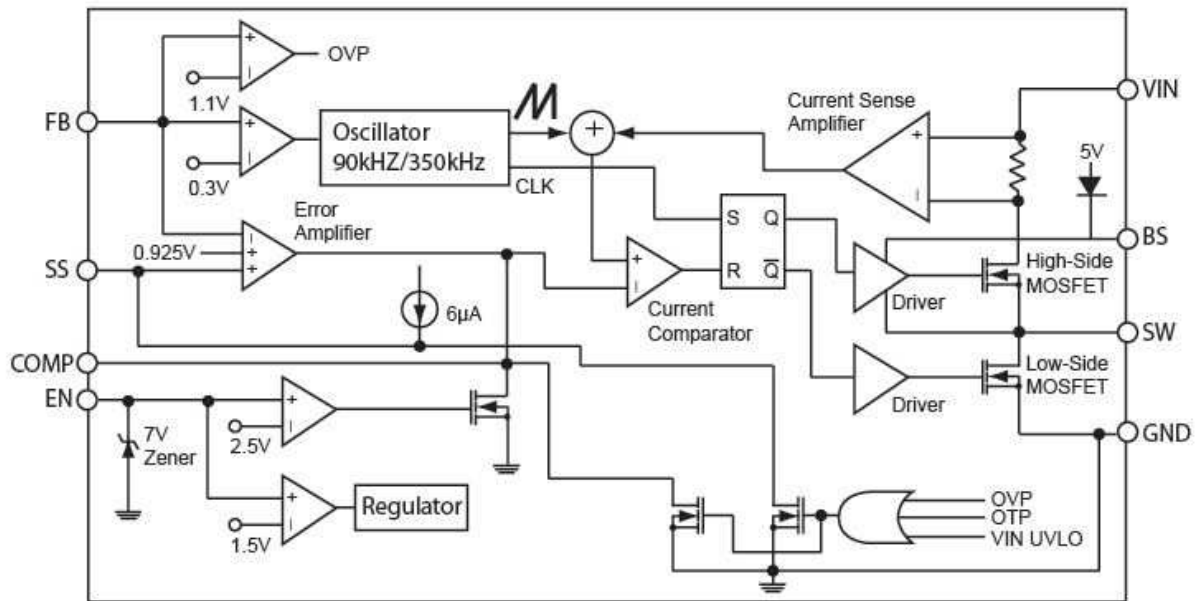

Pin Function Description

Pin NO.	Pin Name	Pin Description
1	BS	High-Side Gate Drive Boost Input. BS supplies the drive for the high-side N-Channel MOSFET switch. Connect a 0.01µF or greater capacitor from SW to BS to power the high side switch.
2	VIN	Power Input. IN supplies the power to the IC, as well as the step-down converter switches. Drive IN with a 4.75V to 23V power source. Bypass IN to GND with a suitably large capacitor to eliminate noise on the input to the IC. See Input Capacitor.
3	SW	Power Switching Output. SW is the switching node that supplies power to the output. Connect the output LC filter from SW to the output load. Note that a capacitor is required from SW to BS to power the high-side switch.
4	GND	Ground.
5	FB	Feedback Input. FB senses the output voltage to regulate that voltage. Drive FB with a resistive voltage divider from the output voltage. The feedback threshold is 0.925V. See Setting the Output Voltage.
6	COMP	Compensation Node. COMP is used to compensate the regulation control loop. Connect a series RC network from COMP to GND to compensate the regulation control loop. In some cases, an additional capacitor from COMP to GND is required. See Compensation Components.
7	EN	Enable Input. EN is a digital input that turns the regulator on or off. Drive EN high to turn on the regulator, drive it low to turn it off. Pull up with 100kΩ resistor for automatic startup.
8	SS	Soft-Start Control Input. SS controls the soft start period. Connect a capacitor from SS to GND to set the soft-start period. A 0.1µF capacitor sets the soft-start period to 15ms. To disable the soft-start feature, leave SS unconnected.

Function Description

The TS3553 is a constant frequency current mode step-down synchronous DC/DC converter. It regulates input voltage from 4.75V to 23V, down to an output voltage as low as 0.925V, and can provide 3A of continuous load current.

Control Loop

During normal operation, the output voltage is sensed at FB pin through a resistive voltage divider and amplified through the error amplifier. The voltage of error amplifier output pin – COMP is compared to the switch current to controls the RS latch. At each cycle, the high side NMOS would be turned on when the oscillator sets the RS latch and would be turned off when current comparator resets the RS latch. When the load current increases, the FB pin voltage drops below 0.925V, it causes the COMP voltage increase until average inductor current arrive at new load current.

Enable

The TS3553 EN pin provides digital control to turn on/turn off the regulator. When the voltage of EN exceeds the threshold voltage, the regulator starts the soft start function. If the EN pin voltage is below than the threshold voltage, only the bandgap voltage is alive. If the EN pin voltage is below than the shutdown threshold voltage, the regulator will be disable and into the shutdown mode.

Maximum Load Current

The maximum load current decreases at lower input voltage because of large IR drop on the high side switch and low side switch. The slope compensation signal reduces the peak inductor current as a function of the duty cycle to prevent sub-harmonic oscillations at duty cycles greater than 50%.

Output Over Voltage Protection

When the FB pin voltage exceeds 20% of the regulation pin voltage, the output over voltage protection function will discharge the COMP pin and the SS pin to GND, turning the high side MOSFET off.

Input Under Voltage Lockout

When the TS3553 power on, the internal circuits are held inactive until VIN exceeds the input UVLO threshold voltage. And the regulator will be disabled when VIN below the input UVLO threshold voltage. The hysteric of the UVLO comparator is 400 mV.

Short Circuit Protection

The TS3553 provides short circuit protection function to prevent the device damage from short condition. When the output short to ground, the oscillator frequency is reduced to prevent the inductor current increasing beyond the current limit. In the meantime, the current limit is also reduced to lower the short current. Once the short condition is removed, the frequency and current limit will return to normal.

Over Temperature Protection

The TS3553 incorporates an over temperature protection circuit to protect itself from overheating. When the junction temperature exceeds the thermal shutdown threshold temperature, the regulator will be shutdown.

Compensation

The stability of the feedback circuit is controlled through COMP pin. The compensation value of the application circuit is optimized for particular requirements. If different conversions are requires, some of the components may need to be changes to ensure stability.

Application Information

Setting Output Voltage

The output voltage is set using a resistive divider from the output to FB. The FB pin regulated voltage is 0.925V. Thus the output voltage is:

$$V_{OUT} = 0.925 \times \frac{R1 + R2}{R2}$$

R2 recommended value is 10KΩ~30KΩ, so R1 is determined by: $R1 = 10.81 \times (V_{OUT} - 0.925) \text{ K}\Omega$

Recommended Component Selection

V _{IN} (V)	V _{OUT} (V)	R1 (KΩ)	R2 (KΩ)	R3 (KΩ)	C3 (nF)	L1 (μH)	C _{OUT} (μF)
12	5	44.1	10	2.2	3.3	15	10 X 2
5 or 12	3.3	25.7	10	2.2	3.3	10	10 X 2
5 or 12	1.8	9.5	10	2.2	3.3	4.7	10 X 2
5 or 12	1.2	3	10	2.2	3.3	3.3	10 X 2
5 or 12	1	0.81	10	2.2	3.3	2.2	10 X 2

Selecting Inductor

The inductor selection depends on the current ripple of inductor, the input voltage and the output voltage.

$$L \geq \frac{V_{OUT}}{f_{OSC} \cdot \Delta I_L} \left(1 - \frac{V_{OUT}}{V_{IN}} \right)$$

Accepting a large current ripple of inductor allows the use of a smaller inductance. However, higher current ripple of inductor can cause higher output ripple voltage and large core loss. By setting an acceptable current ripple of inductor, a suitable inductance can be obtained from above formula.

In addition, it is important to ensure the inductor saturation current exceeds the peak value of inductor current in application to prevent core saturation. The peak value of inductor current can be calculated according to the following formula.

$$I_{PEAK} = I_{OUT(max)} + \frac{V_{OUT}}{2 \times f_{OSC} \cdot L} \left(1 - \frac{V_{OUT}}{V_{IN}} \right)$$

Soft-Start

The TS3553 provides the soft-start function. Initially, the voltage at SS pin is 0V. Then an internal current source of 6 A (typ.) charges an external soft-start capacitor. During the soft-start period, the voltage at SS pin will limit the feedback threshold voltage at FB pin. When the voltage at SS pin is higher than 0.925V, the feedback threshold voltage at FB pin reaches the desired value. The soft-start time can be calculated in accordance with the following formula:

$$t_{SS} = C5 \times \frac{0.925V}{6\mu A}$$

The soft-start capacitor is discharged to GND when the EN pin is connected to GND

Application Information (Continue)

Optional Schottky Diode

A Schottky diode with low forward drop voltage and fast reverse recovery is the ideal choice for better efficiency. The forward drop voltage of a Schottky diode will result in the conduction losses in the diode, and the diode capacitance (C_T or C_D) will cause the switching losses. Therefore, it is necessary to consider both forward voltage drop and diode capacitance for diode selection. In addition, the rating of selected Schottky diode should be able to handle the input voltage and the maximum peak diode current.

Input Capacitor the Output Capacitor

To prevent the high input voltage ripple and noise resulted from high frequency switching, the use of low ESR ceramic capacitor for the maximum RMS current is recommended. The approximated RMS current of the input capacitor can be calculated according to the following formula.

$$I_{CINRMS} \approx \sqrt{I_{OUT(MAX)}^2 \times \frac{V_{OUT}(V_{IN} - V_{OUT})}{V_{IN}^2} + \frac{\Delta I_L^2}{12}}$$

The selection of output capacitor depends on the required output voltage ripple. The output voltage ripple can be expressed as:

$$\Delta V_{OUT} = \frac{\Delta I_L}{8 \times f_{OSC} \times (C3 // C4)} + ESR \Delta I_L$$

For lower output voltage ripple, the use of low ESR ceramic capacitor is recommended. The tantalum capacitor can also be used well, but its ERS is larger than that of ceramic capacitor.

When choosing the input and output ceramic capacitors, X5R and X7R types are recommended because they retain their capacitance over wider ranges of voltage and temperature than other types.

Loop Compensation

In order to avoid the poor output voltage ripple and low efficiency caused by instability, TS3553 requires a proper external compensation network to compensate its feedback loop. In this external compensation network, the compensation resistor, RC, and the compensation capacitor, CC, are used to set the high-frequency integrator gain and the integrator zero. C7 is used to cancel the zero caused by the output capacitor and its ESR. While using the ceramic capacitor as the output capacitor, C7 can be omitted due to the small ESR.

The system has one pole of importance, due to the output capacitor, C3//C4 and the load resistor. This poles is located at:

$$F_{P1} = \frac{1}{2\pi \times (C3 // C4) \times R_{LOAD}}$$

Application Information (Continue)

Loop Compensation

The system has one zero of importance, due to the compensation capacitor, C_c and the compensation resistor, R_c . This zero is located at:

$$F_{Z1} = \frac{1}{2\pi \times C_c \times R_c}$$

The system may have another zero of importance, if the output capacitor has a large capacitance and/or a high ESR value. The zero, due to the ESR and capacitance of the output capacitor, is located at:

$$F_{ESR} = \frac{1}{2\pi \times (C3 // C4) \times R_{ESR}}$$

In this case, a third pole set by the compensation capacitor, $C7$ and the compensation resistor, R_c is used to compensate the effect of the ESR zero on the loop gain. This pole is located at:

$$F_{P2} = \frac{1}{2\pi \times C7 \times R_c}$$

The values of the compensation components given in this data sheet yield a stable control loop for the given output voltage and capacitor. If different conversions and output capacitors are requires, some values of the compensation components may need to be adjusted to ensure stability.

Electrical Characteristics Curve

($T_A=25^\circ\text{C}$, $C_1=10\mu\text{F}$, $C_2=22\mu\text{F}$, $C_3=0.1\mu\text{F}$, $L_1=10\mu\text{H}$ unless otherwise noted)

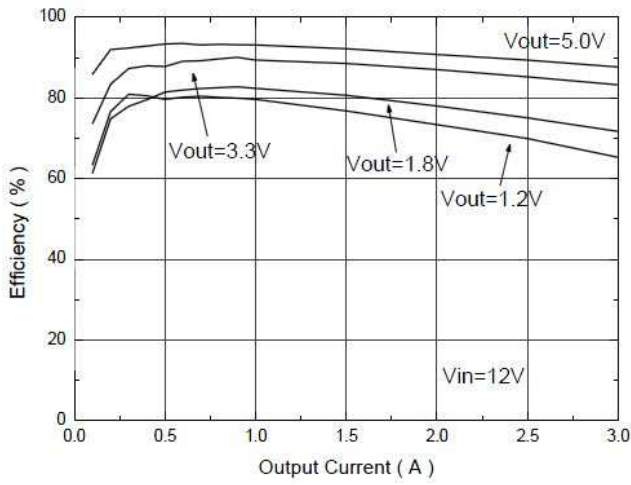

Figure 1. Efficiency vs. Load Current at $V_{IN}=12\text{V}$

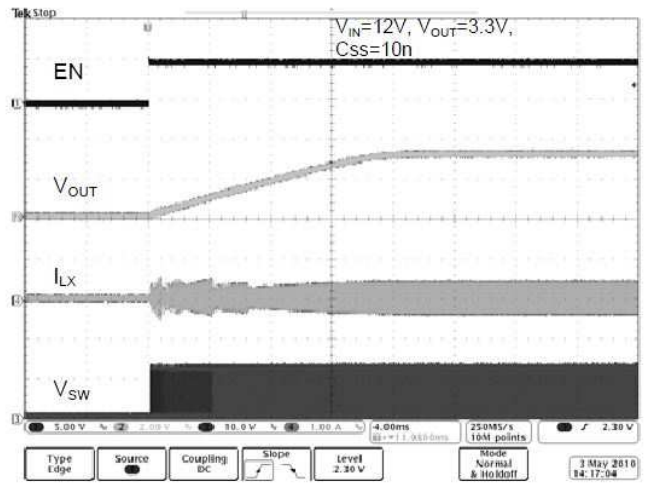

Figure 2. Start-Up Waveform at $I_{OUT}=0\text{A}$

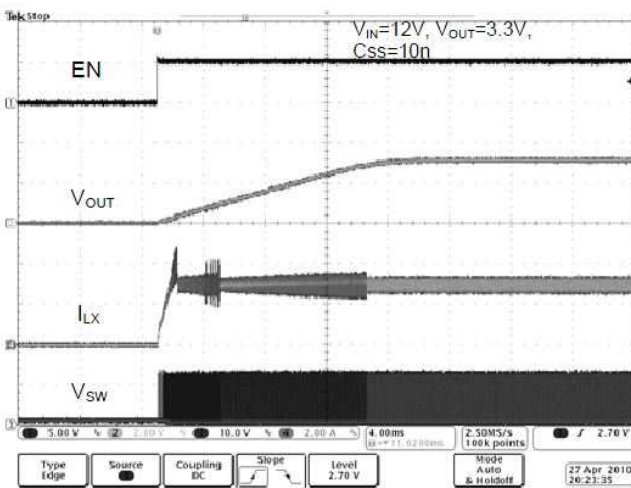

Figure 3. Start-Up Waveform at $I_{OUT}=3\text{A}$

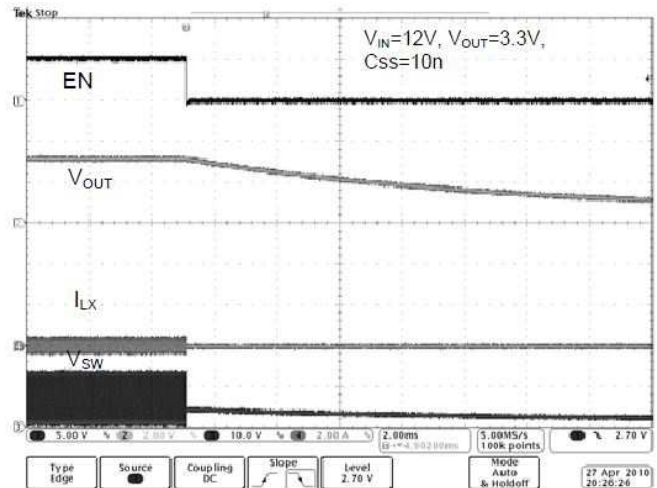

Figure 4. Shutdown Waveform at $I_{OUT}=0\text{A}$

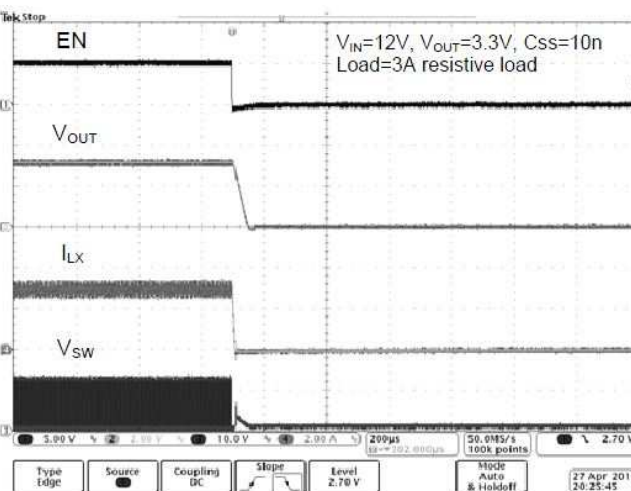

Figure 5. Shutdown Waveform at $I_{OUT}=3\text{A}$

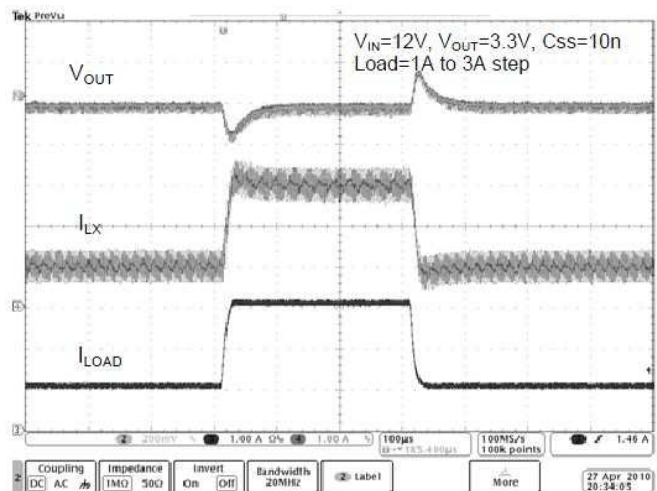

Figure 6. Load Transient

Electrical Characteristics Curve

($T_A=25^{\circ}\text{C}$, $C_1=10\mu\text{F}$, $C_2=22\mu\text{F}$, $C_3=0.1\mu\text{F}$, $L_1=10\mu\text{H}$ unless otherwise noted)

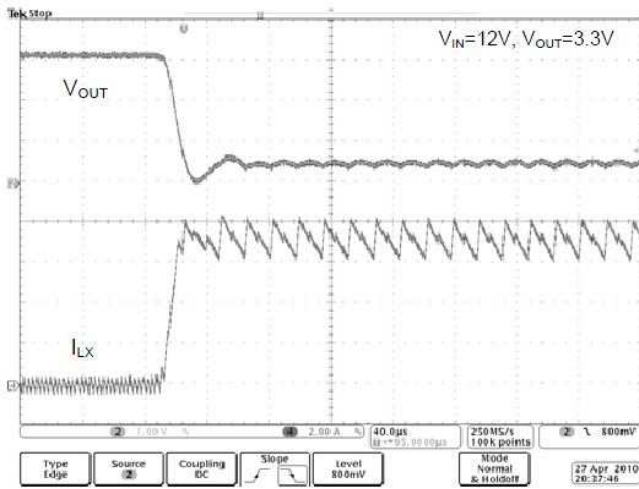

Figure 7. Short Circuit Waveforms

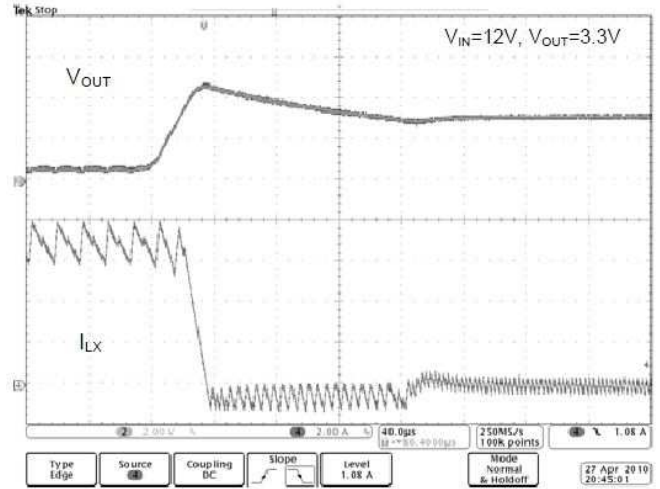

Figure 8. Short Circuit Recovery Waveforms

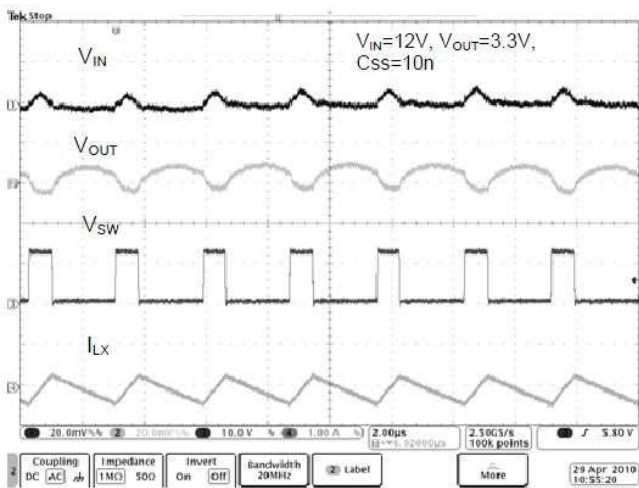

Figure 9. Stability Waveform at $I_{OUT}=0\text{A}$

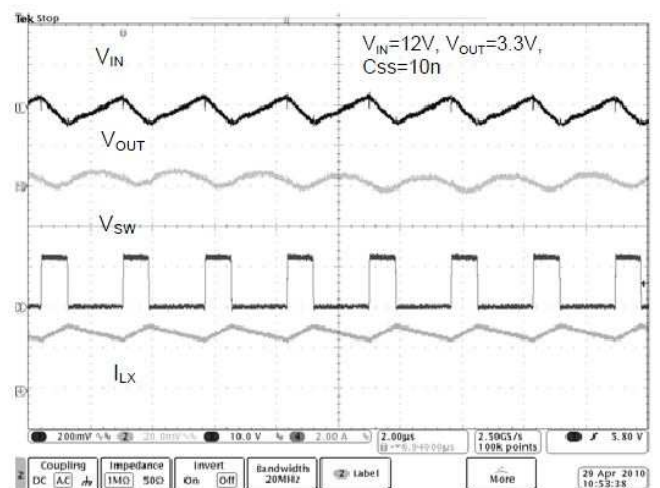
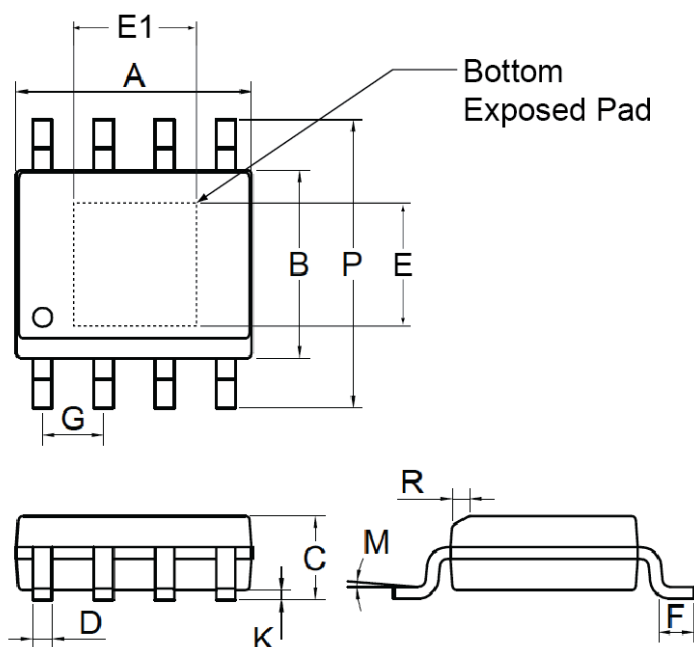

Figure 10. Stability Waveform at $I_{OUT}=3\text{A}$

SOP-8EP Mechanical Drawing



DIM	MILLIMETERS		INCHES	
	MIN	MAX	MIN	MAX.
A	4.80	5.00	0.189	0.196
B	3.80	4.00	0.150	0.157
C	1.35	1.75	0.054	0.068
D	0.35	0.49	0.014	0.019
E	2.05	2.41	0.081	0.095
E1	2.82	3.30	0.111	0.130
F	0.40	1.25	0.016	0.049
G	1.27BSC		0.05BSC	
K	0.10	0.25	0.004	0.009
M	0°	7°	0°	7°
P	5.80	6.20	0.229	0.244
R	0.25	0.50	0.010	0.019

Marking Diagram

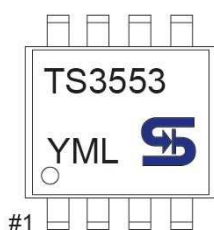

- Y = Year Code
- M = Month Code for Halogen Free Product
(O=Jan, P=Feb, Q=Mar, R=Apl, S=May, T=Jun, U=Jul, V=Aug, W=Sep, X=Oct, Y=Nov, Z=Dec)
- L = Lot Code

Notice

Specifications of the products displayed herein are subject to change without notice. TSC or anyone on its behalf, assumes no responsibility or liability for any errors or inaccuracies.

Information contained herein is intended to provide a product description only. No license, express or implied, to any intellectual property rights is granted by this document. Except as provided in TSC's terms and conditions of sale for such products, TSC assumes no liability whatsoever, and disclaims any express or implied warranty, relating to sale and/or use of TSC products including liability or warranties relating to fitness for a particular purpose, merchantability, or infringement of any patent, copyright, or other intellectual property right.

The products shown herein are not designed for use in medical, life-saving, or life-sustaining applications. Customers using or selling these products for use in such applications do so at their own risk and agree to fully indemnify TSC for any damages resulting from such improper use or sale.