

Pop-free 120 mW stereo headphone amplifier

Datasheet - production data

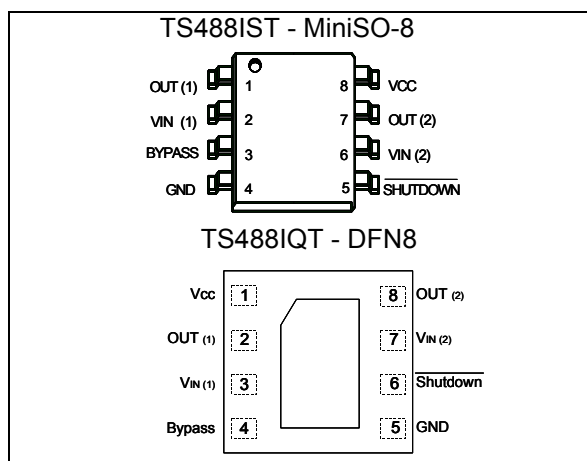

Description

The TS488/9 is an enhancement of TS486/7 that eliminates pop and click noise and reduces the number of external passive components.

The TS488/9 is a dual audio power amplifier capable of driving, in single-ended mode, either a 16 Ω or a 32 Ω stereo headset.

Capable of descending to low voltages, it delivers up to 31 mW per channel (into 16 Ω loads) of continuous average power with 0.1% THD+N in the audio bandwidth from a 2.5 V power supply.

An externally-controlled standby mode reduces the supply current to 10 nA (typ.). The unity gain stable TS488/9 is configured by external gain-setting resistors.

Features

- Pop and click noise protection circuitry
- Operating range from $V_{CC} = 2.2$ V to 5.5 V
- Standby mode active low (TS488) or high (TS489)
- Output power:
 - 120 mW at 5 V, into 16 Ω with 0.1% THD+N max (1 kHz)
 - 55 mW at 3.3 V, into 16 Ω with 0.1% THD+N max (1 kHz)
- Low current consumption: 2.7 mA max at 5 V
- Ultra-low standby current consumption: 10 nA typical
- High signal-to-noise ratio
- High crosstalk immunity: 102 dB ($F = 1$ kHz)
- PSRR: 70 dB typ. ($F = 1$ kHz), inputs grounded at 5 V
- Unity-gain stable
- Short-circuit protection circuitry
- Available in lead-free MiniSO-8 & DFN8 (2 x 2 mm)

Applications

- Headphone amplifiers
- Mobile phones, PDAs, computer motherboards
- High-end TVs, portable audio players

Contents

- 1 Typical application schematic 3**
- 2 Absolute maximum ratings and operating conditions 4**
- 3 Electrical characteristics 5**
- 4 Application information 22**
 - 4.1 Power dissipation and efficiency 22
 - 4.2 Total power dissipation 23
 - 4.3 Lower cutoff frequency 23
 - 4.4 Higher cutoff frequency 24
 - 4.5 Gain setting 25
 - 4.6 Decoupling of the circuit 25
 - 4.7 Standby mode 25
 - 4.8 Wake-up time 26
 - 4.9 POP performance 26
 - 4.10 Connecting the headphones 27
- 5 Package information 28**
 - 5.1 MiniSO-8 package information 29
 - 5.2 DFN8 package information 30
- 6 Ordering information 31**
- 7 Revision history 32**

1 Typical application schematic

Figure 1. Typical application for the TS488-TS489

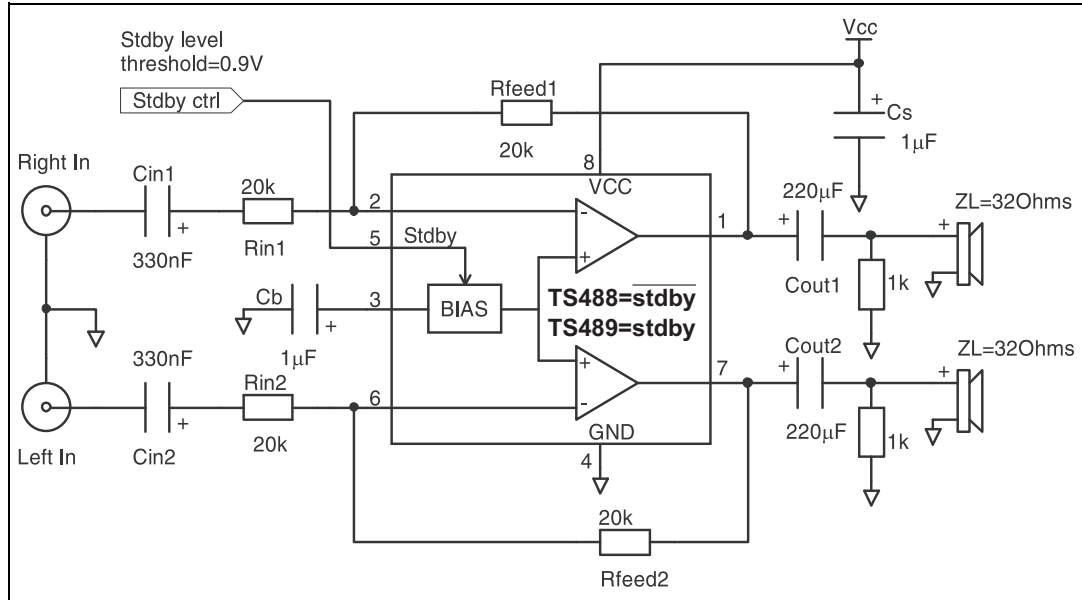

Table 1. Application component information

Component	Functional description
R _{in1,2}	Inverting input resistor that sets the closed loop gain in conjunction with R _{feed} . This resistor also forms a high pass filter with C _{in} ($F_c = 1 / (2 \times \text{Pi} \times R_{in} \times C_{in})$).
C _{in1,2}	Input coupling capacitor that blocks the DC voltage at the amplifier's input terminal.
R _{feed1,2}	Feedback resistor that sets the closed loop gain in conjunction with R _{in} . $A_V = \text{Closed Loop Gain} = -R_{feed}/R_{in}$.
C _s	Supply output capacitor that provides power supply filtering.
C _b	Bypass capacitor that provides half supply filtering.
C _{out1,2}	Output coupling capacitor that blocks the DC voltage at the load input terminal. This capacitor also forms a high pass with R _L ($F_c = 1 / (2 \times \text{Pi} \times R_L \times C_{out})$).

2 Absolute maximum ratings and operating conditions

Table 2. Absolute maximum ratings

Symbol	Parameter	Value	Unit
V_{CC}	Supply voltage ⁽¹⁾	6	V
V_i	Input voltage	-0.3 V to $V_{CC} + 0.3$ V	V
T_{stg}	Storage temperature	-65 to +150	°C
T_j	Maximum junction temperature	150	°C
R_{thja}	Thermal resistance junction-to-ambient		°C/W
	MiniSO-8 DFN8	215 70	
P_{diss}	Power dissipation ⁽²⁾ :		W
	MiniSO-8 DFN8	0.58 1.79	
ESD	Human body model (pin-to-pin)	2	kV
ESD	Machine model 220 pF - 240 pF (pin-to-pin)	200	V
Latch-up	Latch-up immunity (all pins)	200	mA
	Lead temperature (soldering, 10 sec)	250	°C
	Output short-circuit to V_{CC} or GND	continuous ⁽³⁾	

1. All voltage values are measured with respect to the ground pin.
2. P_{diss} is calculated with $T_{amb} = 25$ °C, $T_j = 150$ °C.
3. Attention must be paid to continuous power dissipation ($V_{DD} \times 250$ mA). Short-circuits can cause excessive heating and destructive dissipation. Exposing the IC to a short-circuit for an extended period of time will dramatically reduce the product's life expectancy.

Table 3. Operating conditions

Symbol	Parameter	Value	Unit
V_{CC}	Supply voltage	2.2 to 5.5	V
R_L	Load resistor	≥ 16	Ω
T_{oper}	Operating free air temperature range	-40 to + 85	°C
C_L	Load capacitor:		pF
	$R_L = 16$ to 100 Ω $R_L > 100$ Ω	400 100	
V_{STBY}	Standby voltage input: TS488 active, TS489 in standby TS488 in standby, TS489 active	$1.5 \leq V \leq V_{CC}$ $GND \leq V_{STBY} \leq 0.4$ ⁽¹⁾	V
R_{thja}	Thermal resistance junction-to-ambient		°C/W
	MiniSO-8 DFN8 ⁽²⁾	190 40	

1. The minimum current consumption (I_{STBY}) is guaranteed at GND (TS488) or V_{CC} (TS489) for the whole temperature range.
2. When mounted on a 4-layer PCB.

3 Electrical characteristics

**Table 4. Electrical characteristics at $V_{CC} = +5\text{ V}$
with $GND = 0\text{ V}$, $T_{amb} = 25\text{ °C}$ (unless otherwise specified)**

Symbol	Parameter	Conditions	Min.	Typ.	Max.	Unit
I_{CC}	Supply current	No input signal, no load		2	2.7	mA
I_{STBY}	Standby current	No input signal, $V_{STBY} = GND$ for TS488, $R_L = 32\ \Omega$		10	1000	nA
		No input signal, $V_{STBY} = V_{CC}$ for TS489, $R_L = 32\ \Omega$		10	1000	
P_{out}	Output power	THD+N = 0.1% max, $F = 1\text{ kHz}$, $R_L = 32\ \Omega$		75		mW
		THD+N = 1% max, $F = 1\text{ kHz}$, $R_L = 32\ \Omega$	70	80		
		THD+N = 0.1% max, $F = 1\text{ kHz}$, $R_L = 16\ \Omega$		120		
		THD+N = 1% max, $F = 1\text{ kHz}$, $R_L = 16\ \Omega$	100	130		
THD+N	Total harmonic distortion + noise	$A_V = -1$, $R_L = 32\ \Omega$, $P_{out} = 60\text{ mW}$, $20\text{ Hz} \leq F \leq 20\text{ kHz}$		0.3		%
		$A_V = -1$, $R_L = 16\ \Omega$, $P_{out} = 90\text{ mW}$, $20\text{ Hz} \leq F \leq 20\text{ kHz}$		0.3		
PSRR	Power supply rejection ratio, inputs grounded ⁽¹⁾	$A_V = -1$, $R_L \geq 16\ \Omega$, $C_b = 1\ \mu\text{F}$, $F = 1\text{ kHz}$, $V_{ripple} = 200\text{ mVpp}$	64	70		dB
		$A_V = -1$, $R_L \geq 16\ \Omega$, $C_b = 1\ \mu\text{F}$, $F = 217\text{ Hz}$, $V_{ripple} = 200\text{ mVpp}$	62	68		
V_O	Output swing	V_{OL} : $R_L = 32\ \Omega$		0.23	0.31	V
		V_{OH} : $R_L = 32\ \Omega$	4.53	4.72		
		V_{OL} : $R_L = 16\ \Omega$		0.44	0.57	
		V_{OH} : $R_L = 16\ \Omega$	4.18	4.48		
SNR	Signal-to-noise ratio	A-weighted, $A_V = -1$, $R_L = 32\ \Omega$, THD+N < 0.4%, $20\text{ Hz} \leq F \leq 20\text{ kHz}$		105		dB
Crosstalk	Channel separation	$R_L = 32\ \Omega$, $A_V = -1$ $F = 1\text{ kHz}$ $F = 20\text{ Hz to } 20\text{ kHz}$		-102 -84		dB
C_i	Input capacitance			1		pF
GBP	Gain bandwidth product	$R_L = 32\ \Omega$		1.1		MHz
SR	Slew rate, unity gain inverting	$R_L = 16\ \Omega$		0.65		V/ μs
V_{IO}	Input offset voltage	$V_{icm} = V_{CC}/2$		1	20	mV
t_{wu}	Wake-up time			100		ms

1. Guaranteed by design and evaluation.

**Table 5. Electrical characteristics at $V_{CC} = +3.3\text{ V}$
with $GND = 0\text{ V}$, $T_{amb} = 25\text{ °C}$ (unless otherwise specified) ⁽¹⁾**

Symbol	Parameter	Conditions	Min.	Typ.	Max.	Unit
I_{CC}	Supply current	No input signal, no load		1.8	2.5	mA
I_{STBY}	Standby current	No input signal, $V_{STBY} = GND$ for TS488, $R_L = 32\ \Omega$		10	1000	nA
		No input signal, $V_{STBY} = V_{CC}$ for TS489, $R_L = 32\ \Omega$		10	1000	
P_{out}	Output power	THD+N = 0.1% max, $F = 1\text{ kHz}$, $R_L = 32\ \Omega$		34		mW
		THD+N = 1% max, $F = 1\text{ kHz}$, $R_L = 32\ \Omega$	30	35		
		THD+N = 0.1% max, $F = 1\text{ kHz}$, $R_L = 16\ \Omega$		55		
		THD+N = 1% max, $F = 1\text{ kHz}$, $R_L = 16\ \Omega$	47	57		
THD+N	Total harmonic distortion + noise	$A_V = -1$, $R_L = 32\ \Omega$, $P_{out} = 16\text{ mW}$, $20\text{ Hz} \leq F \leq 20\text{ kHz}$		0.3		%
		$A_V = -1$, $R_L = 16\ \Omega$, $P_{out} = 35\text{ mW}$, $20\text{ Hz} \leq F \leq 20\text{ kHz}$		0.3		
PSRR	Power supply rejection ratio, inputs grounded ⁽²⁾	$A_V = -1$, $R_L \geq 16\ \Omega$, $C_b = 1\ \mu\text{F}$, $F = 1\text{ kHz}$, $V_{ripple} = 200\text{ mVpp}$	63	69		dB
		$A_V = -1$, $R_L \geq 16\ \Omega$, $C_b = 1\ \mu\text{F}$, $F = 217\text{ Hz}$, $V_{ripple} = 200\text{ mVpp}$	61	67		
V_O	Output swing	V_{OL} : $R_L = 32\ \Omega$		0.15	0.2	V
		V_{OH} : $R_L = 32\ \Omega$	3.03	3.12		
		V_{OL} : $R_L = 16\ \Omega$		0.28	0.36	
		V_{OH} : $R_L = 16\ \Omega$	2.82	2.97		
SNR	Signal-to-noise ratio	A-weighted, $A_V = -1$, $R_L = 32\ \Omega$, THD+N < 0.4%, $20\text{ Hz} \leq F \leq 20\text{ kHz}$		102		dB
Crosstalk	Channel separation	$R_L = 32\ \Omega$, $A_V = -1$ $F = 1\text{ kHz}$ $F = 20\text{ Hz to } 20\text{ kHz}$		-102 -84		dB
C_i	Input capacitance			1		pF
GBP	Gain bandwidth product	$R_L = 32\ \Omega$		1.1		MHz
SR	Slew rate, unity gain inverting	$R_L = 16\ \Omega$		0.6		V/ μs
V_{IO}	Input offset voltage	$V_{icm} = V_{CC}/2$		1	20	mV
t_{wu}	Wake-up time			100		ms

1. All electrical values are guaranteed with correlation measurements at 2.5 V and 5 V.
2. Guaranteed by design and evaluation.

**Table 6. Electrical characteristics at $V_{CC} = +2.5\text{ V}$
with $GND = 0\text{ V}$, $T_{amb} = 25\text{ °C}$ (unless otherwise specified)**

Symbol	Parameter	Conditions	Min.	Typ.	Max.	Unit
I_{CC}	Supply current	No input signal, no load		1.8	2.5	mA
I_{STBY}	Standby current	No input signal, $V_{STBY} = GND$ for TS488, $R_L = 32\ \Omega$		10	1000	nA
		No input signal, $V_{STBY} = V_{CC}$ for TS489, $R_L = 32\ \Omega$		10	1000	
P_{out}	Output power	THD+N = 0.1% max, $F = 1\text{ kHz}$, $R_L = 32\ \Omega$		19		mW
		THD+N = 1% max, $F = 1\text{ kHz}$, $R_L = 32\ \Omega$	18	20		
		THD+N = 0.1% max, $F = 1\text{ kHz}$, $R_L = 16\ \Omega$		31		
		THD+N = 1% max, $F = 1\text{ kHz}$, $R_L = 16\ \Omega$	27	32		
THD+N	Total harmonic distortion + noise	$A_V = -1$, $R_L = 32\ \Omega$, $P_{out} = 10\text{ mW}$, $20\text{ Hz} \leq F \leq 20\text{ kHz}$		0.3		%
		$A_V = -1$, $R_L = 16\ \Omega$, $P_{out} = 16\text{ mW}$, $20\text{ Hz} \leq F \leq 20\text{ kHz}$		0.3		
PSRR	Power supply rejection ratio, inputs grounded ⁽¹⁾	$A_V = -1$, $R_L \geq 16\ \Omega$, $C_b = 1\ \mu\text{F}$, $F = 1\text{ kHz}$, $V_{ripple} = 200\text{ mVpp}$		68		dB
		$A_V = -1$, $R_L \geq 16\ \Omega$, $C_b = 1\ \mu\text{F}$, $F = 217\text{ Hz}$, $V_{ripple} = 200\text{ mVpp}$		66		
V_O	Output swing	V_{OL} : $R_L = 32\ \Omega$		0.12	0.16	V
		V_{OH} : $R_L = 32\ \Omega$	2.3	2.36		
		V_{OL} : $R_L = 16\ \Omega$		0.22	0.28	
		V_{OH} : $R_L = 16\ \Omega$	2.15	2.25		
SNR	Signal-to-noise ratio	A-weighted, $A_V = -1$, $R_L = 32\ \Omega$, THD+N < 0.4%, $20\text{ Hz} \leq F \leq 20\text{ kHz}$		100		dB
Crosstalk	Channel separation	$R_L = 32\ \Omega$, $A_V = -1$ $F = 1\text{ kHz}$ $F = 20\text{ Hz to } 20\text{ kHz}$		-102 -84		dB
C_i	Input capacitance			1		pF
GBP	Gain bandwidth product	$R_L = 32\ \Omega$		1.1		MHz
SR	Slew rate, unity gain inverting	$R_L = 16\ \Omega$		0.6		V/ μs
V_{IO}	Input offset voltage	$V_{icm} = V_{CC}/2$		1	20	mV
t_{wu}	Wake-up time			100		ms

1. Guaranteed by design and evaluation.

Table 7. Index of graphics

Description	Figure
Open-loop frequency response	Figure 2 to Figure 11
Power derating curves	Figure 12 to Figure 13
Signal-to-noise ratio vs. power supply voltage	Figure 14 to Figure 19
Power dissipation vs. output power per channel	Figure 20 to Figure 22
Power supply rejection ratio vs. frequency	Figure 23 to Figure 25
Total harmonic distortion plus noise vs. output power	Figure 26 to Figure 43
Total harmonic distortion plus noise vs. frequency	Figure 44 to Figure 52
Output power vs. load resistance	Figure 53 to Figure 55
Output power vs. power supply voltage	Figure 56 , Figure 57
Output voltage swing vs. power supply voltage	Figure 58
Current consumption vs. power supply voltage	Figure 59
Current consumption vs. standby voltage	Figure 60 to Figure 65
Crosstalk vs. frequency	Figure 66 to Figure 77

Figure 2. Open-loop frequency response

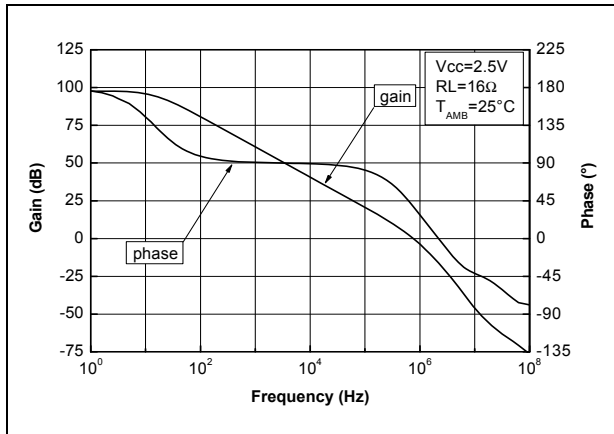

Figure 3. Open-loop frequency response

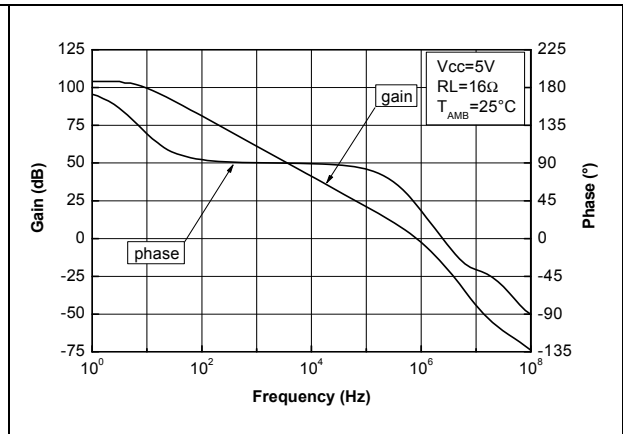

Figure 4. Open-loop frequency response

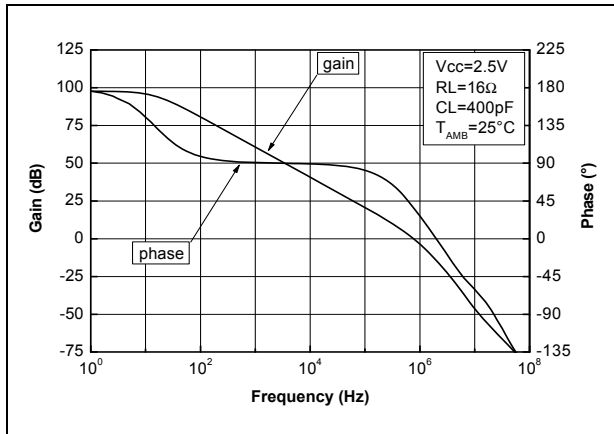

Figure 5. Open-loop frequency response

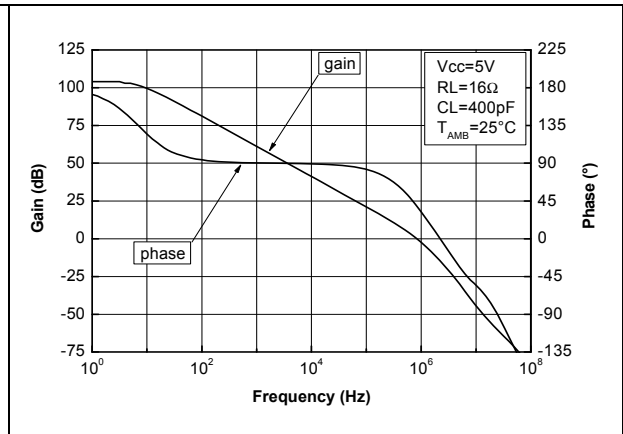

Figure 6. Open-loop frequency response

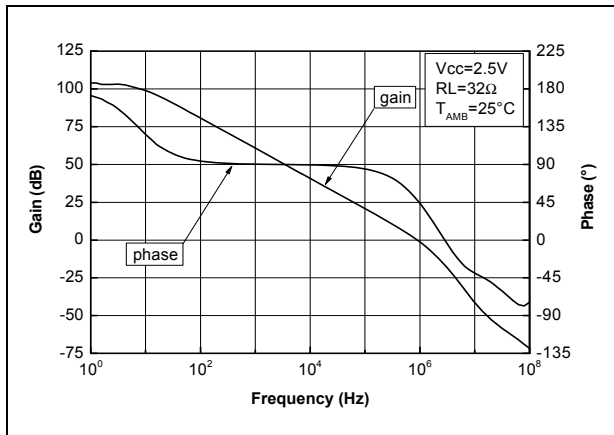

Figure 7. Open-loop frequency response

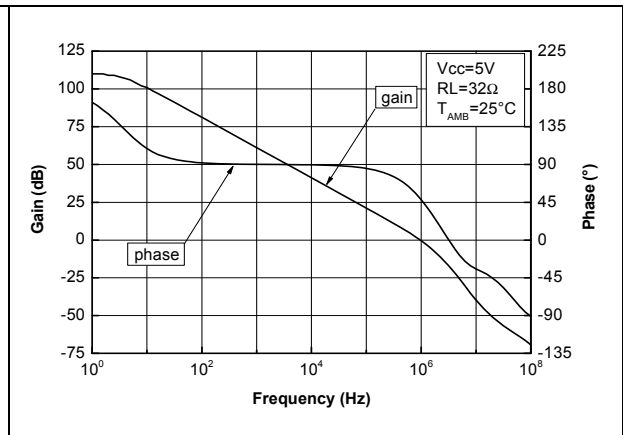

Figure 8. Open-loop frequency response

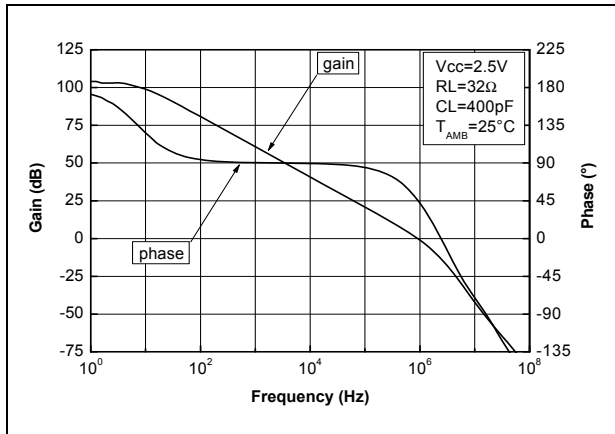

Figure 9. Open-loop frequency response

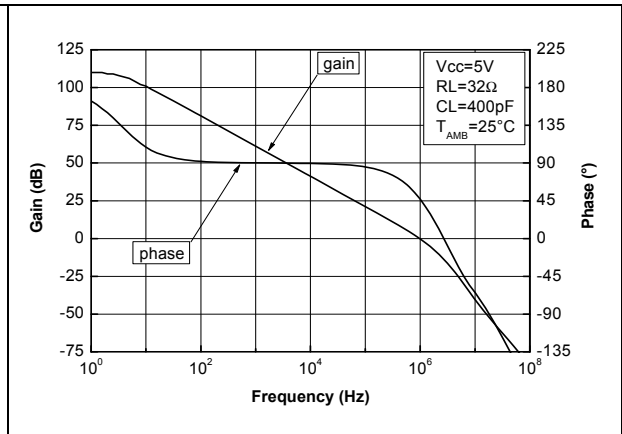

Figure 10. Open-loop frequency response

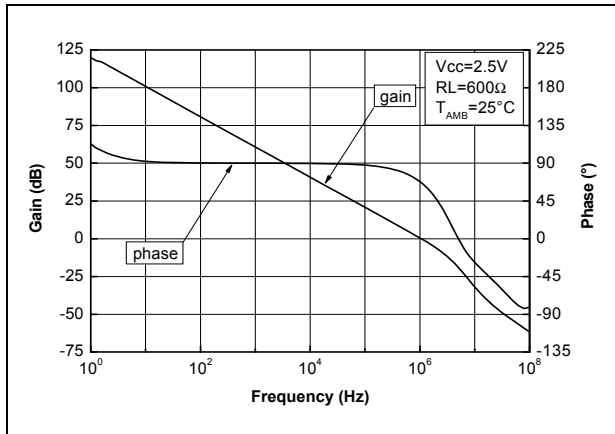

Figure 11. Open-loop frequency response

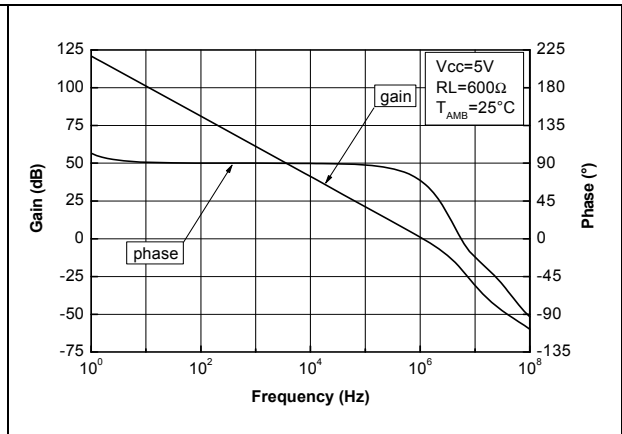

Figure 12. Power derating curves

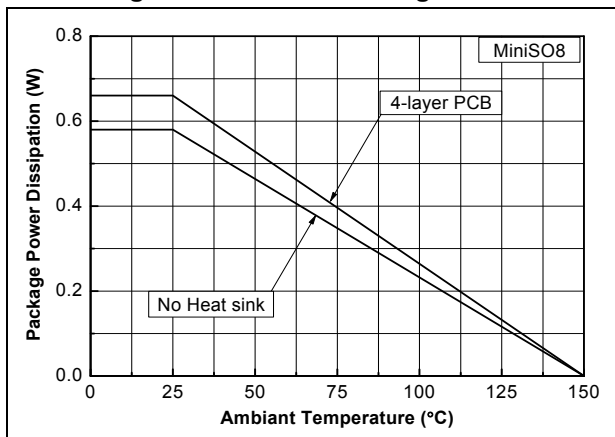

Figure 13. Power derating curves

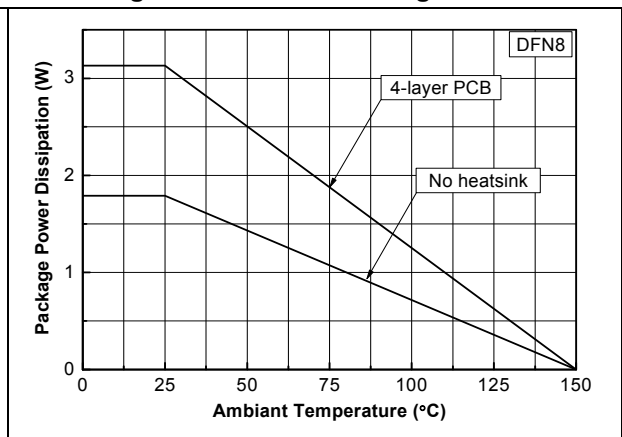

Figure 14. Signal-to-noise ratio vs. power supply voltage

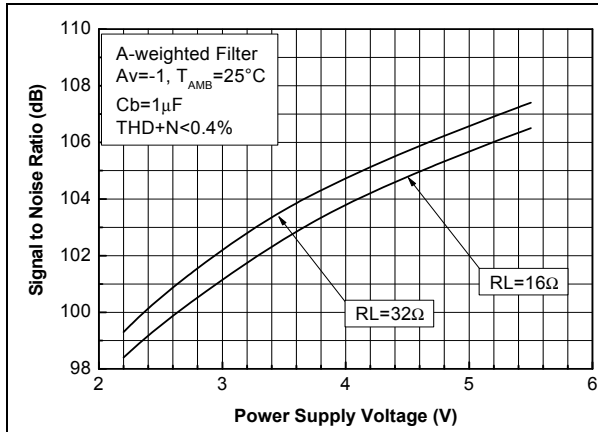

Figure 15. Signal-to-noise ratio vs. power supply voltage

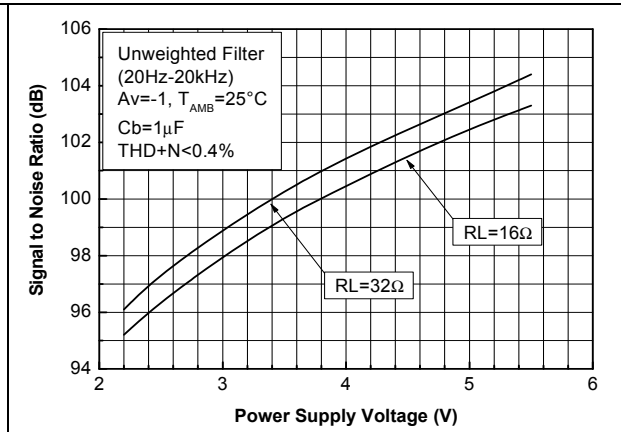

Figure 16. Signal-to-noise ratio vs. power supply voltage

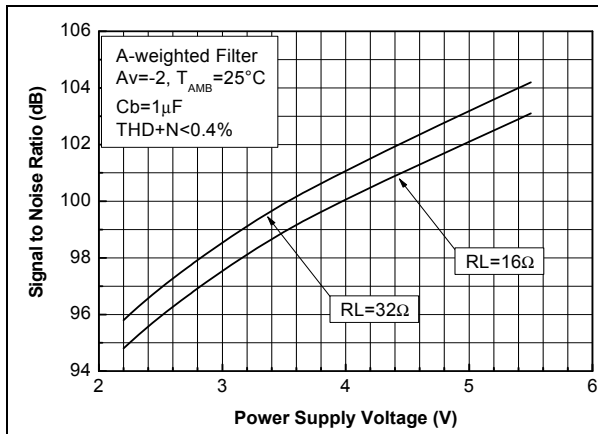

Figure 17. Signal-to-noise ratio vs. power supply voltage

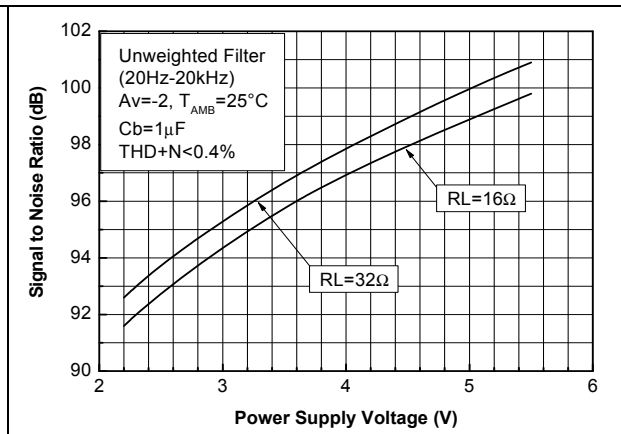

Figure 18. Signal-to-noise ratio vs. power supply voltage

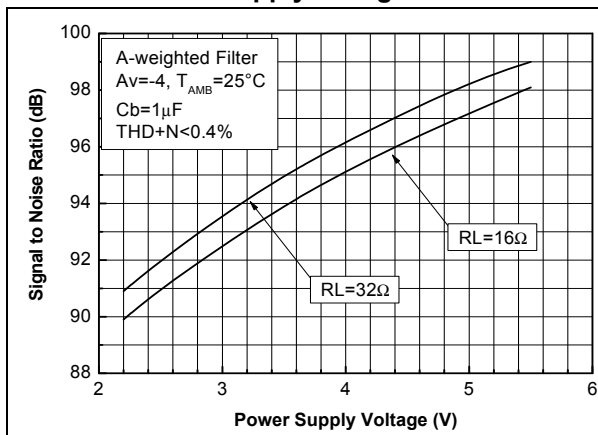

Figure 19. Signal-to-noise ratio vs. power supply voltage

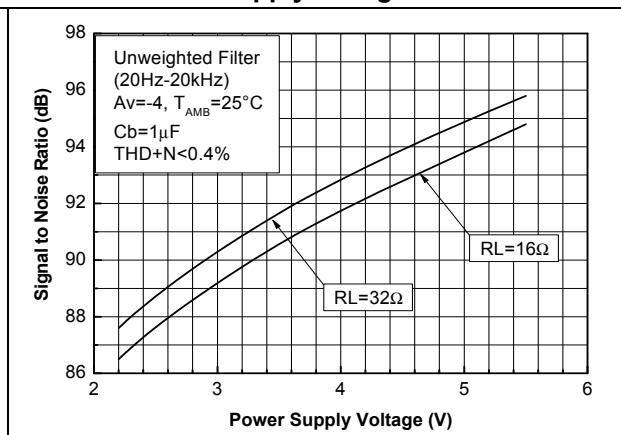

Figure 20. Power dissipation vs. output power per channel

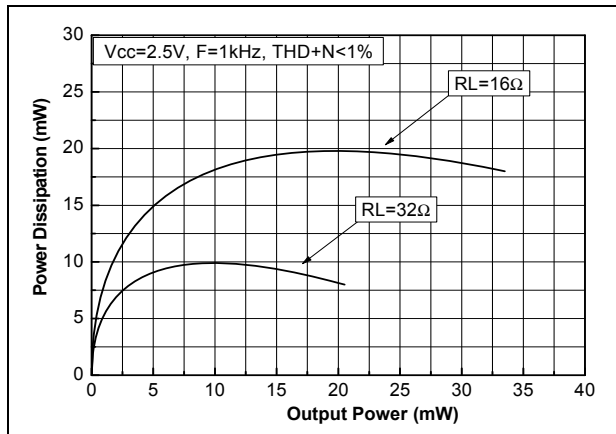

Figure 21. Power dissipation vs. output power per channel

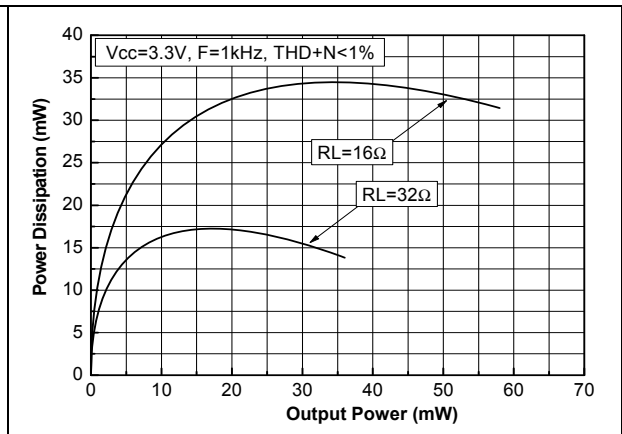

Figure 22. Power dissipation vs. output power per channel

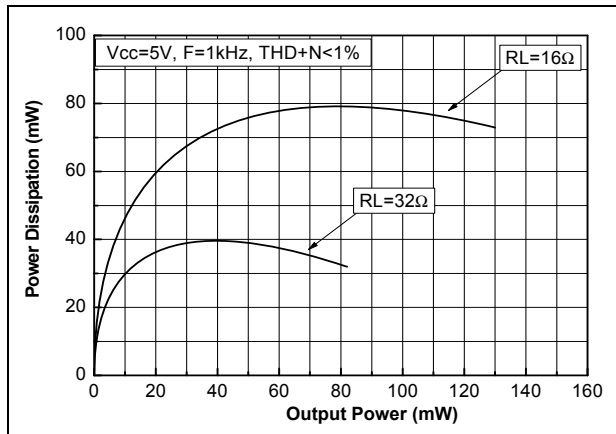

Figure 23. Power supply rejection ratio vs. frequency

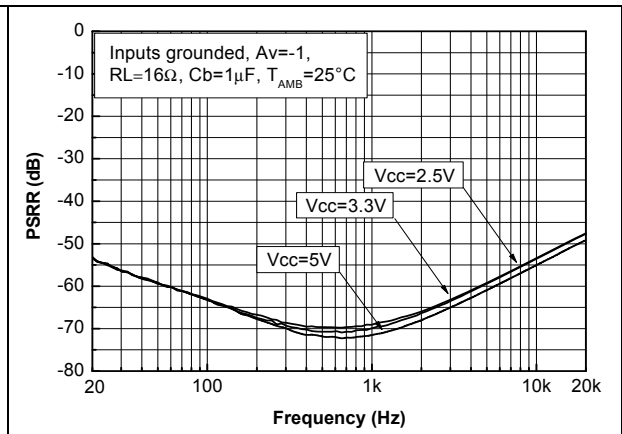

Figure 24. Power supply rejection ratio vs. frequency

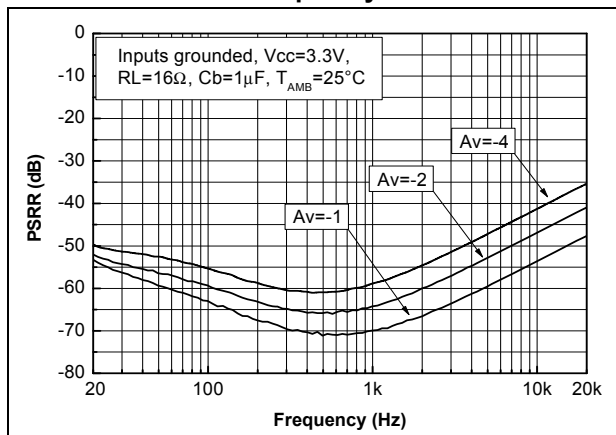

Figure 25. Power supply rejection ratio vs. frequency

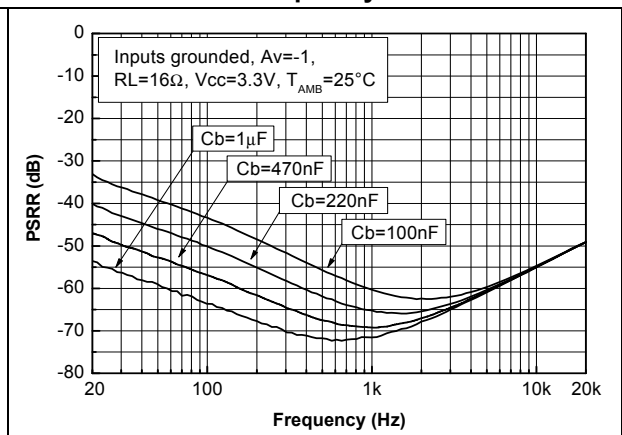

Figure 26. Total harmonic distortion plus noise vs. output power

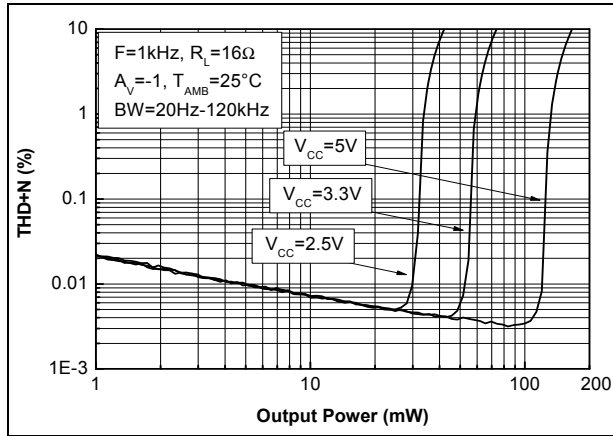

Figure 27. Total harmonic distortion plus noise vs. output power

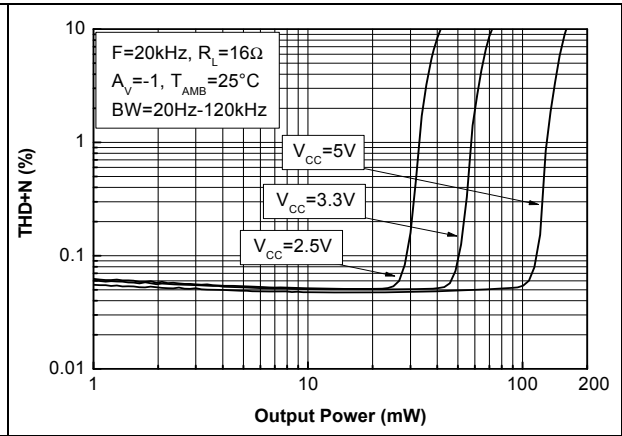

Figure 28. Total harmonic distortion plus noise vs. output power

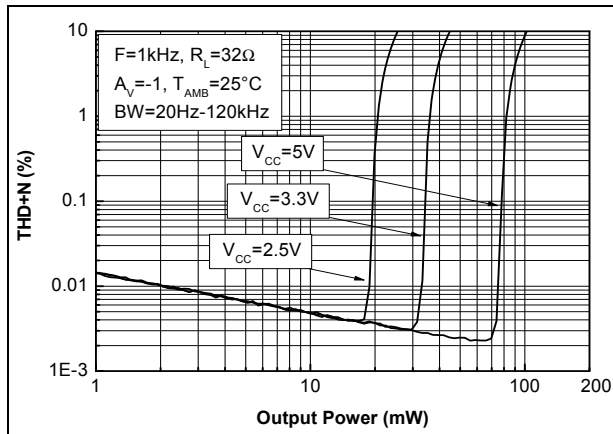

Figure 29. Total harmonic distortion plus noise vs. output power

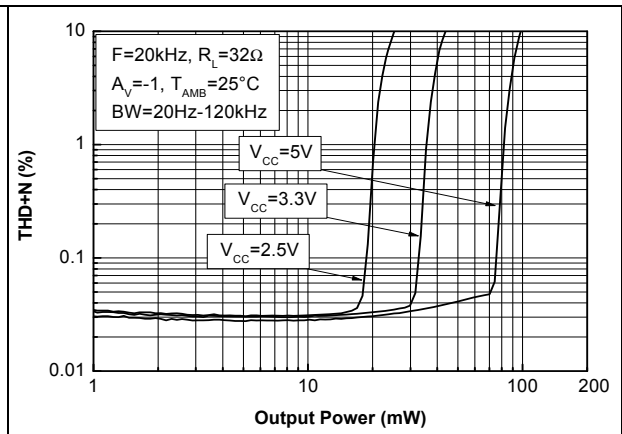

Figure 30. Total harmonic distortion plus noise vs. output power

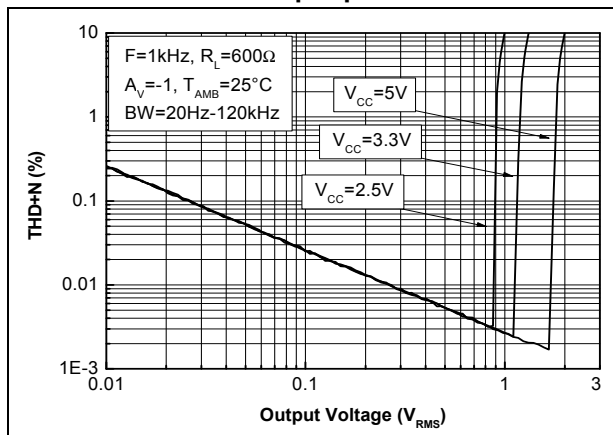

Figure 31. Total harmonic distortion plus noise vs. output power

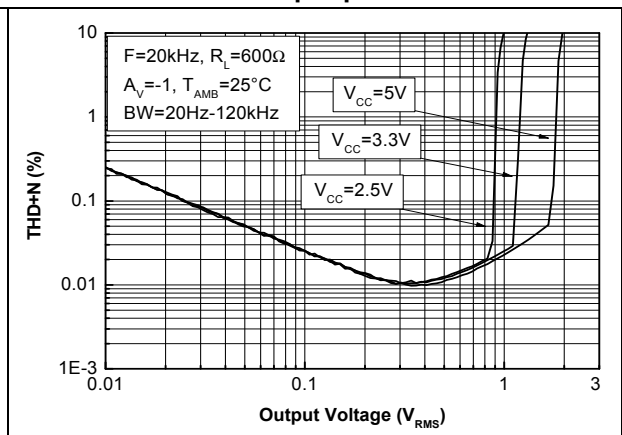

Figure 32. Total harmonic distortion plus noise vs. output power

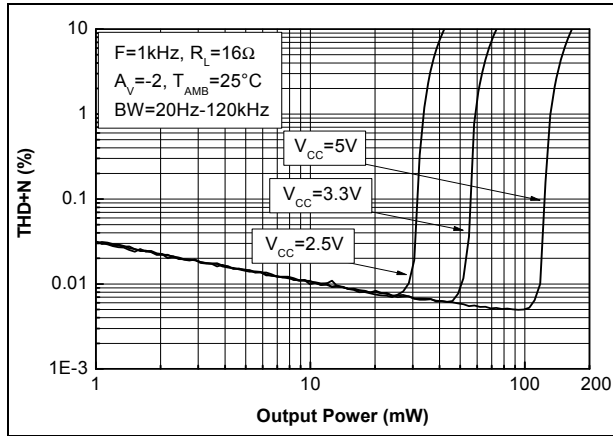

Figure 33. Total harmonic distortion plus noise vs. output power

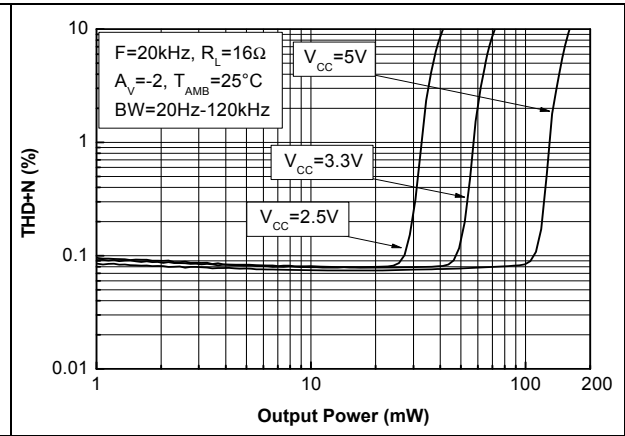

Figure 34. Total harmonic distortion plus noise vs. output power

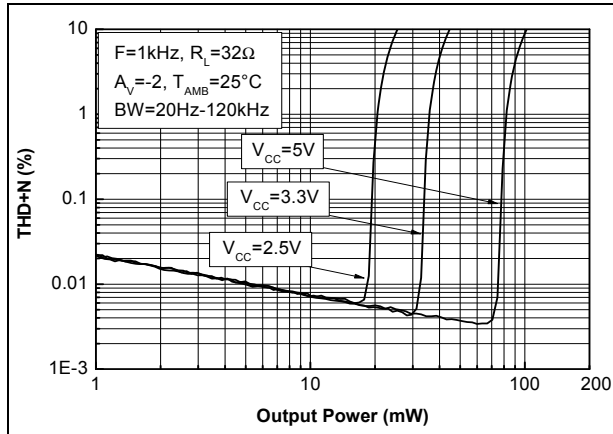

Figure 35. Total harmonic distortion plus noise vs. output power

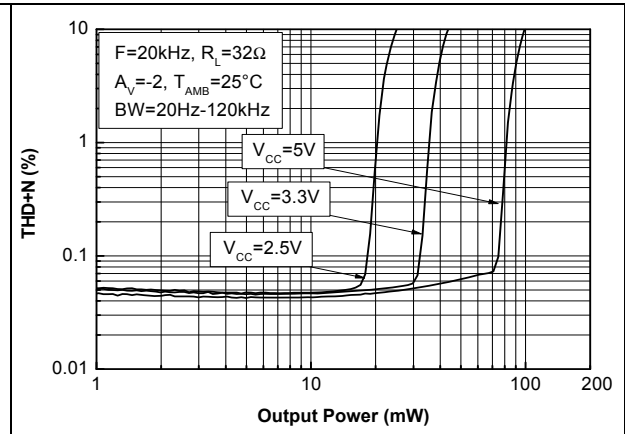

Figure 36. Total harmonic distortion plus noise vs. output power

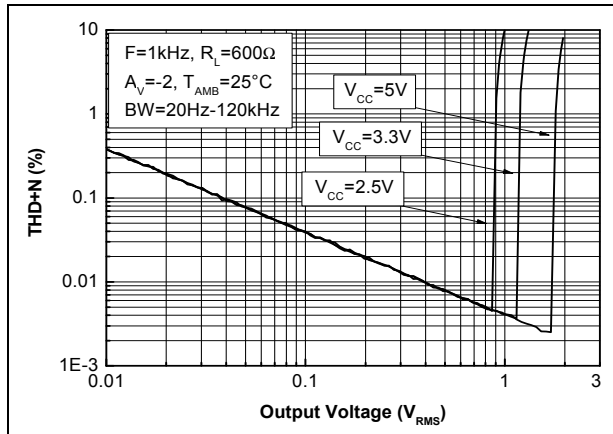

Figure 37. Total harmonic distortion plus noise vs. output power

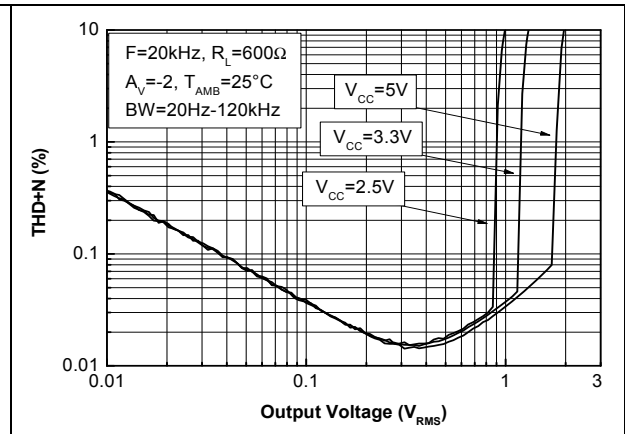

Figure 38. Total harmonic distortion plus noise vs. output power

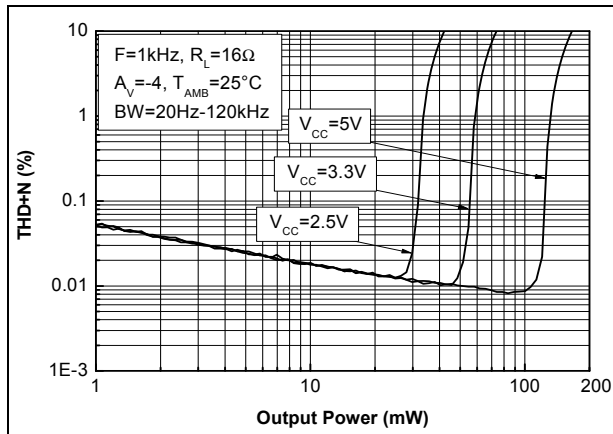

Figure 39. Total harmonic distortion plus noise vs. output power

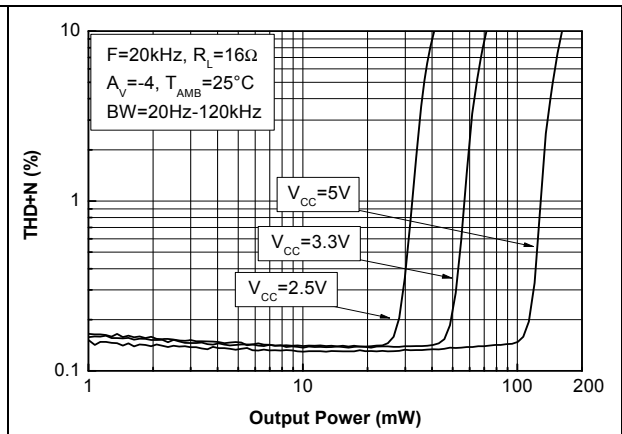

Figure 40. Total harmonic distortion plus noise vs. output power

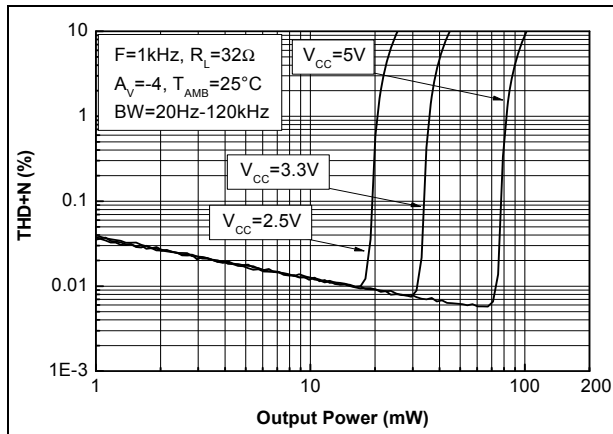

Figure 41. Total harmonic distortion plus noise vs. output power

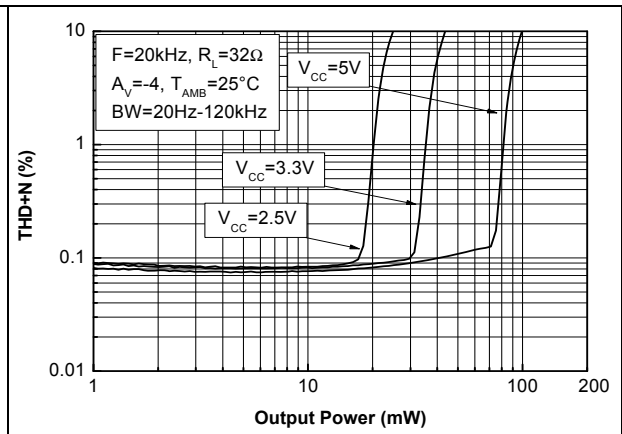

Figure 42. Total harmonic distortion plus noise vs. output power

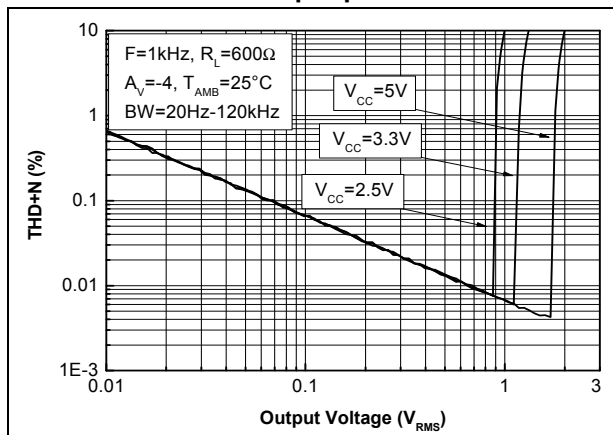

Figure 43. Total harmonic distortion plus noise vs. output power

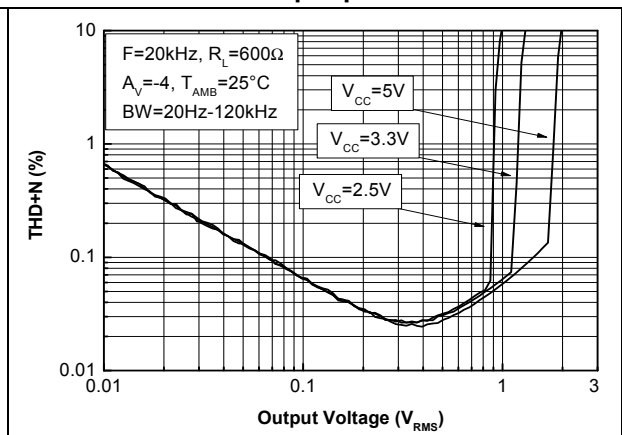

Figure 44. Total harmonic distortion plus noise vs. frequency

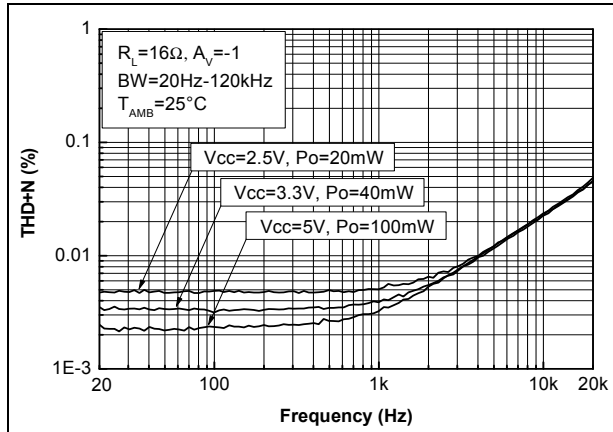

Figure 45. Total harmonic distortion plus noise vs. frequency

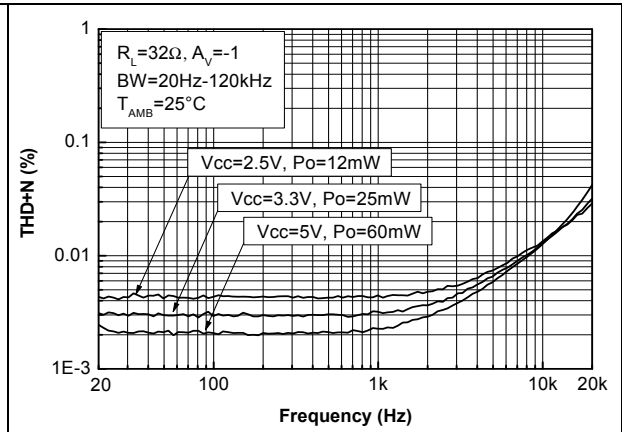

Figure 46. Total harmonic distortion plus noise vs. frequency

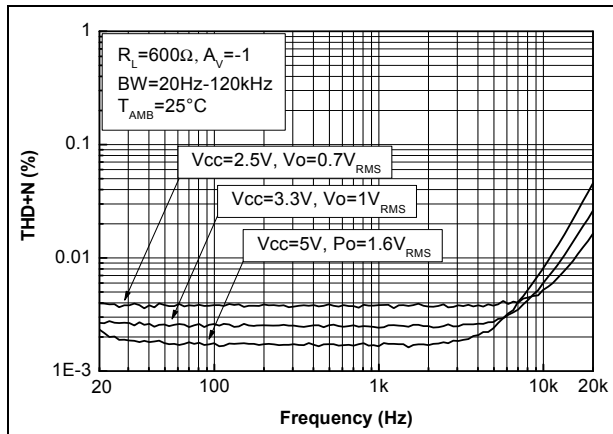

Figure 47. Total harmonic distortion plus noise vs. frequency

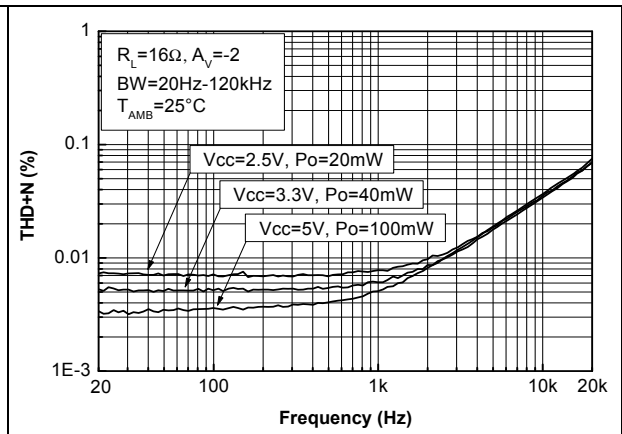

Figure 48. Total harmonic distortion plus noise vs. frequency

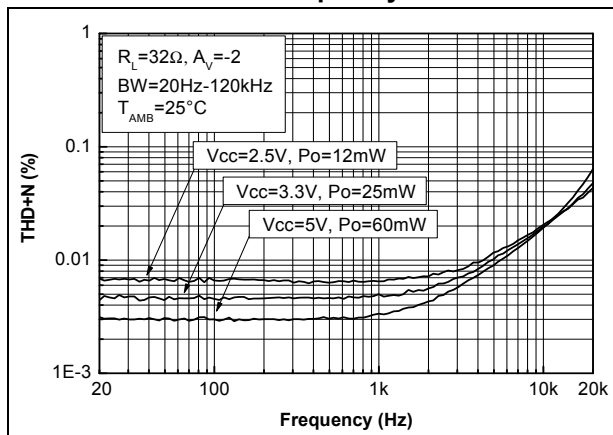

Figure 49. Total harmonic distortion plus noise vs. frequency

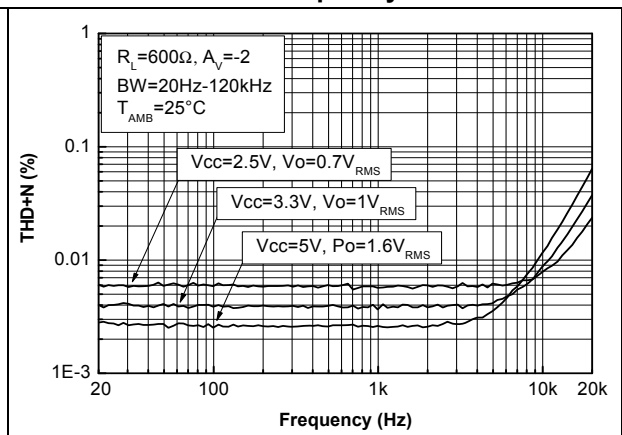

Figure 50. Total harmonic distortion plus noise vs. frequency

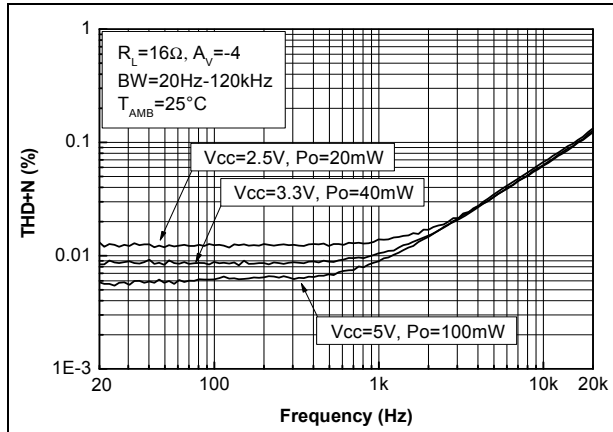

Figure 51. Total harmonic distortion plus noise vs. frequency

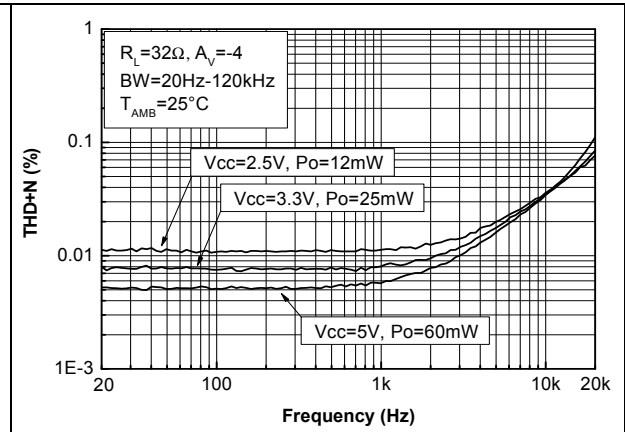

Figure 52. Total harmonic distortion plus noise vs. frequency

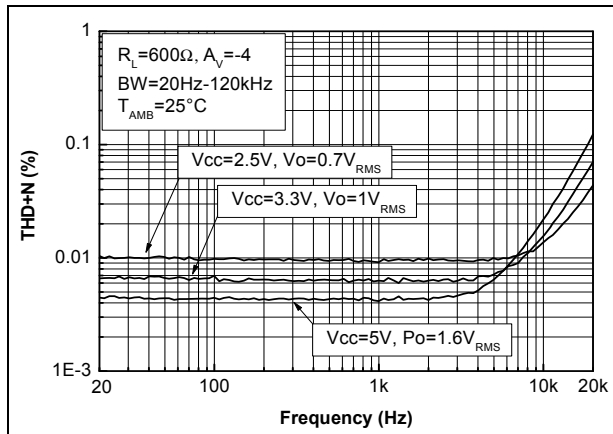

Figure 53. Output power vs. load resistance

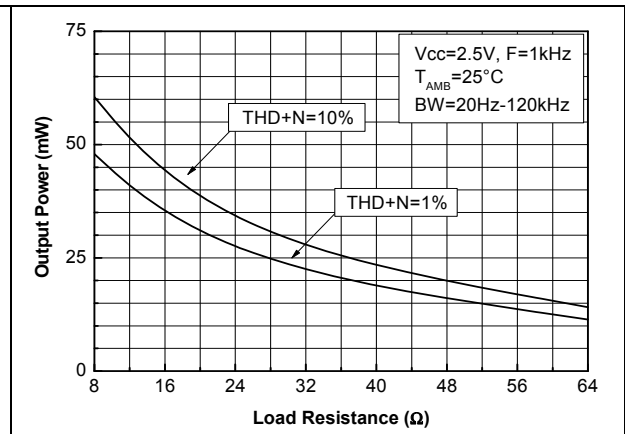

Figure 54. Output power vs. load resistance

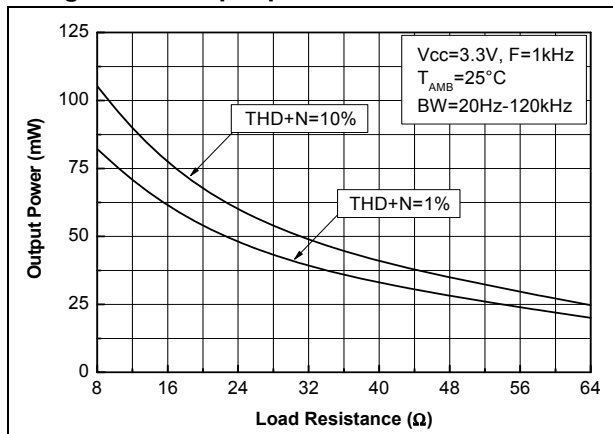

Figure 55. Output power vs. load resistance

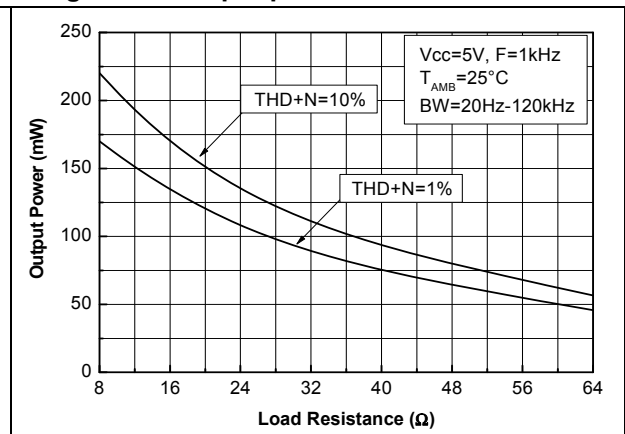

Figure 56. Output power vs. power supply voltage

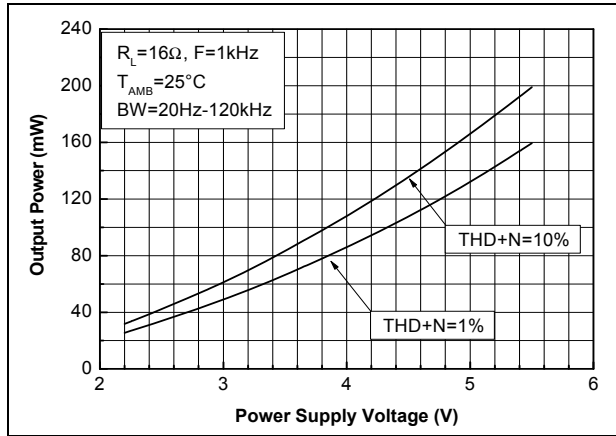

Figure 57. Output power vs. power supply voltage

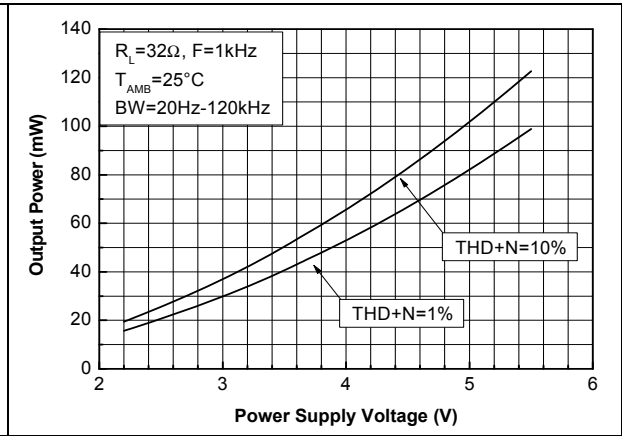

Figure 58. Output voltage swing vs. power supply voltage

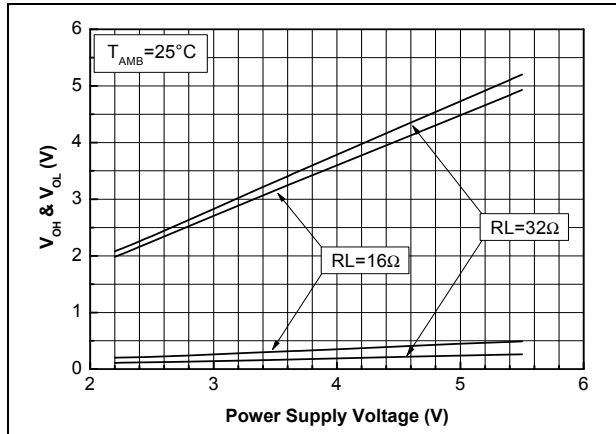

Figure 59. Current consumption vs. power supply voltage

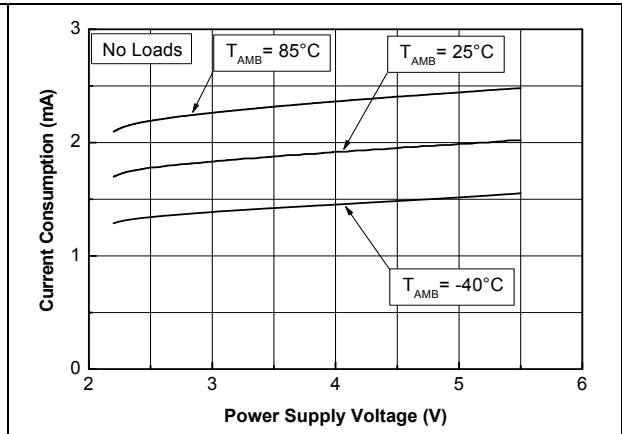

Figure 60. Current consumption vs. standby voltage

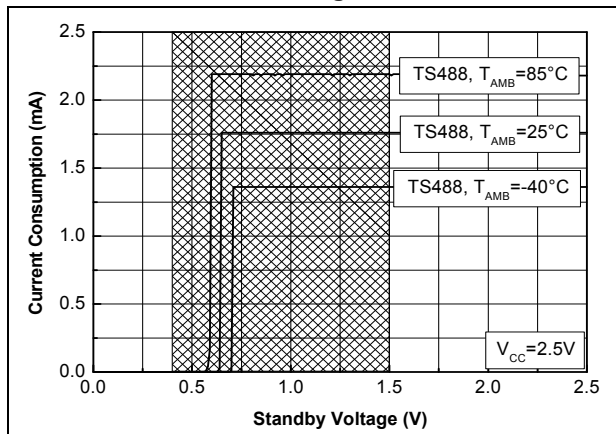

Figure 61. Current consumption vs. standby voltage

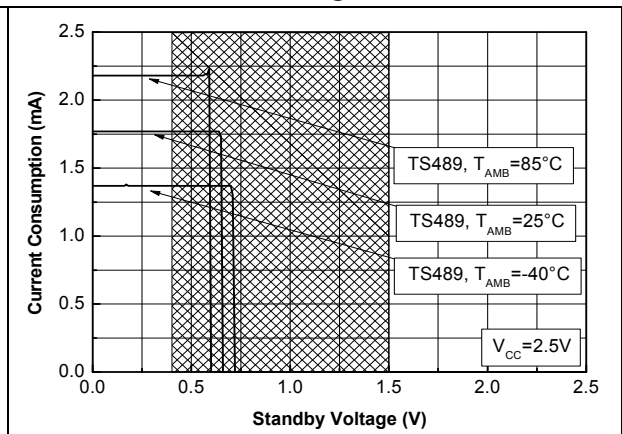

Figure 62. Current consumption vs. standby voltage

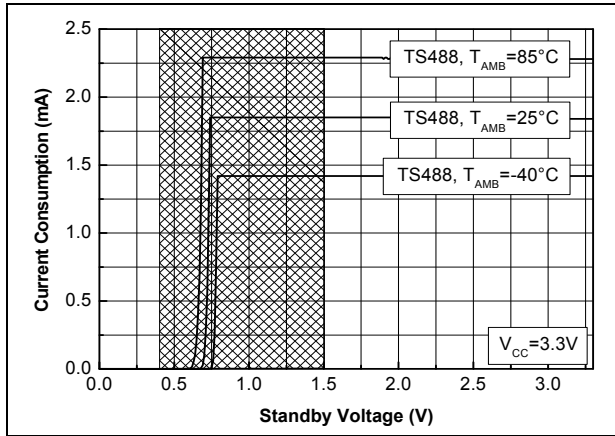

Figure 63. Current consumption vs. standby voltage

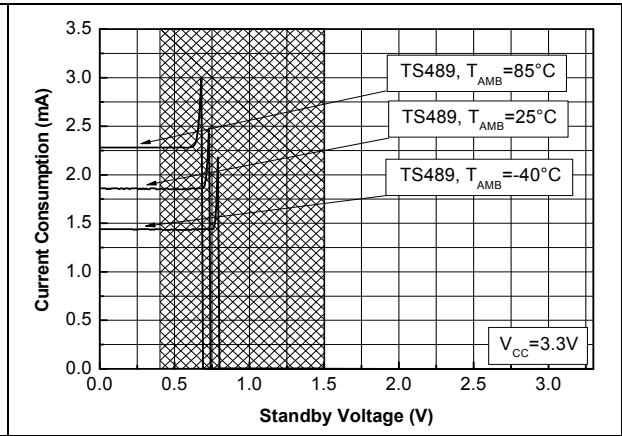

Figure 64. Current consumption vs. standby voltage

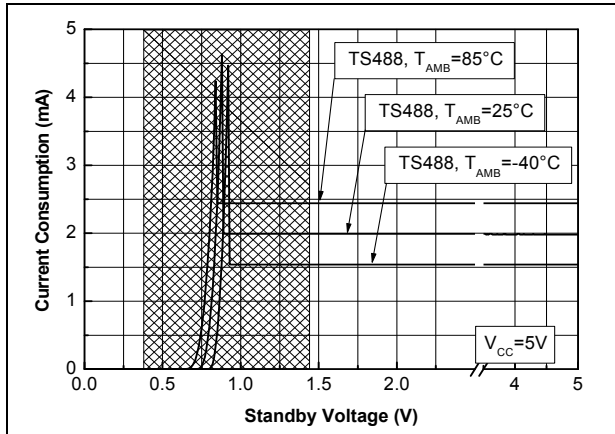

Figure 65. Current consumption vs. standby voltage

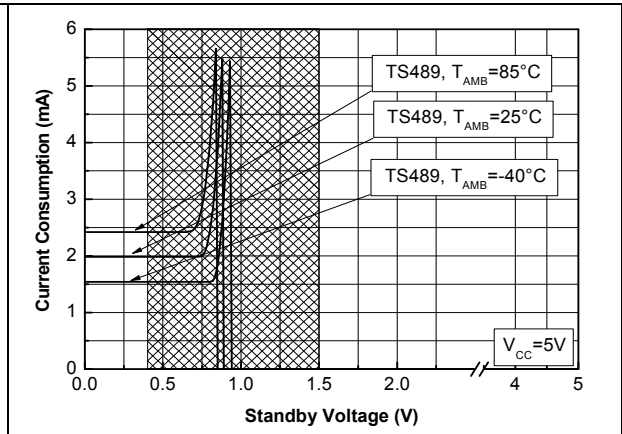

Figure 66. Crosstalk vs. frequency

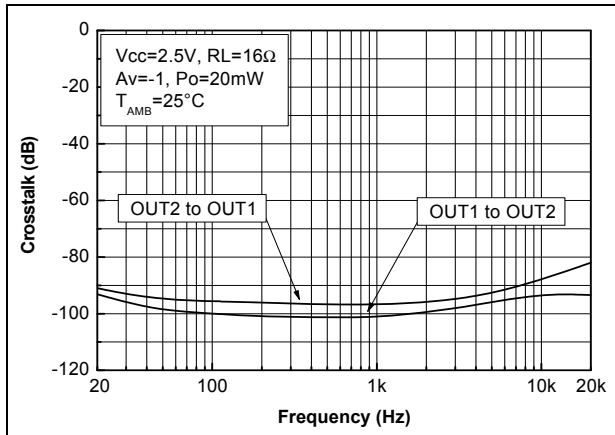

Figure 67. Crosstalk vs. frequency

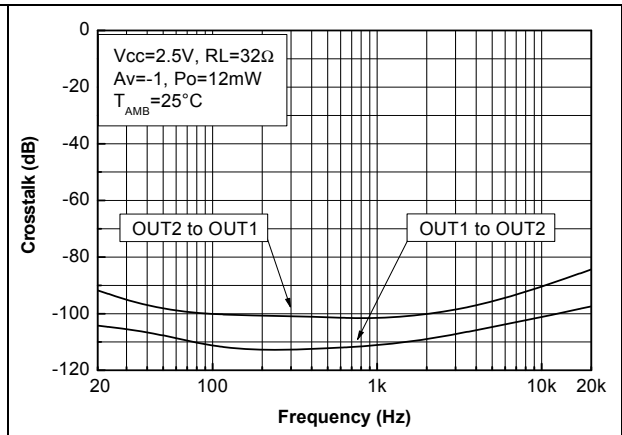

Figure 68. Crosstalk vs. frequency

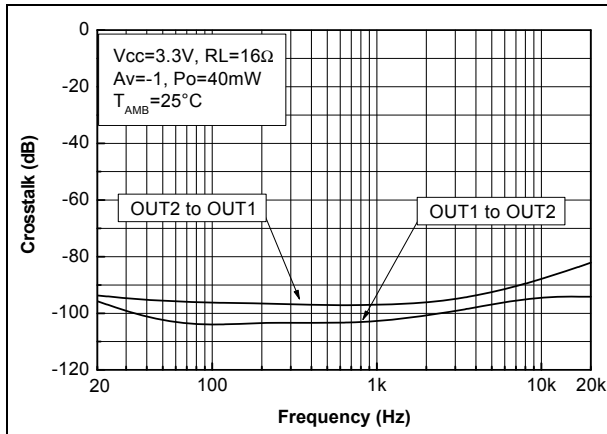

Figure 69. Crosstalk vs. frequency

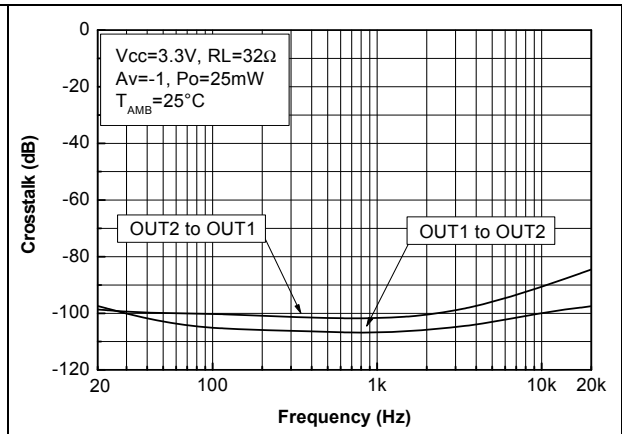

Figure 70. Crosstalk vs. frequency

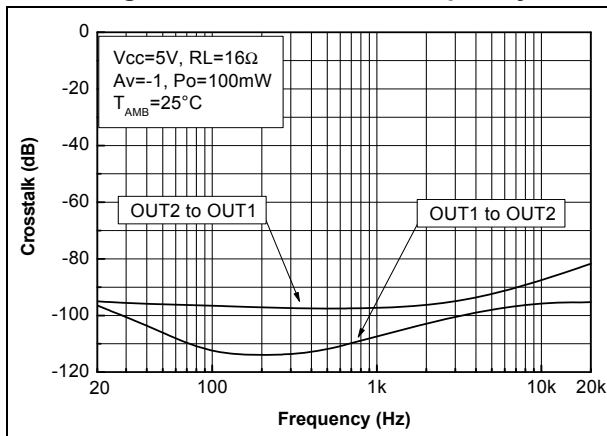

Figure 71. Crosstalk vs. frequency

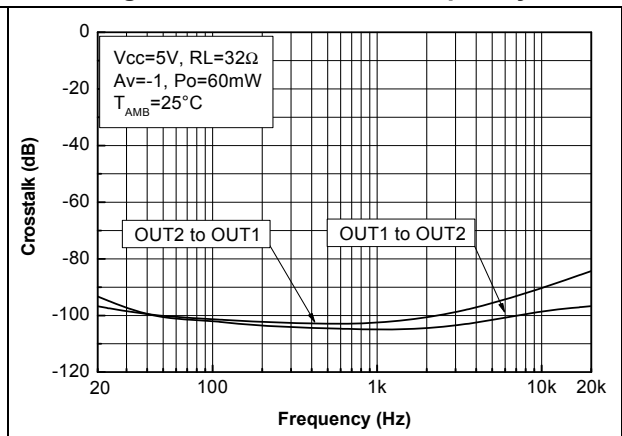

Figure 72. Crosstalk vs. frequency

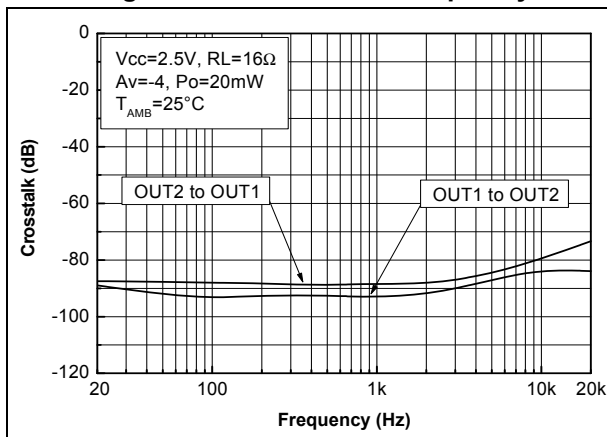

Figure 73. Crosstalk vs. frequency

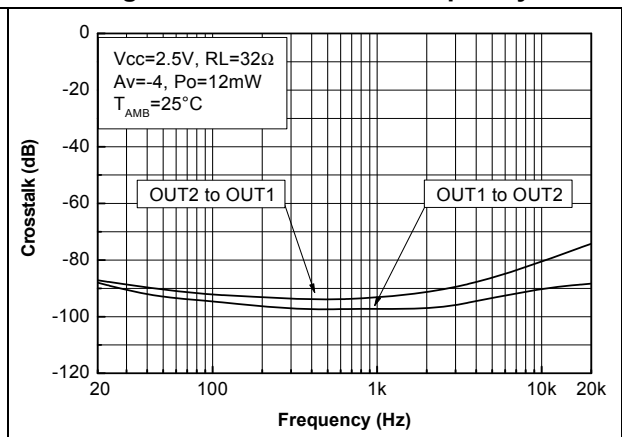

Figure 74. Crosstalk vs. frequency

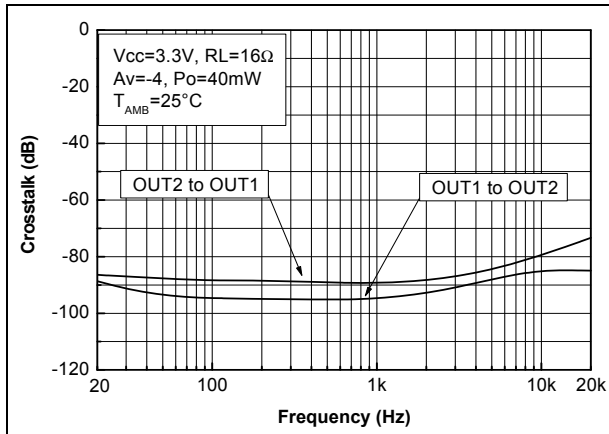

Figure 75. Crosstalk vs. frequency

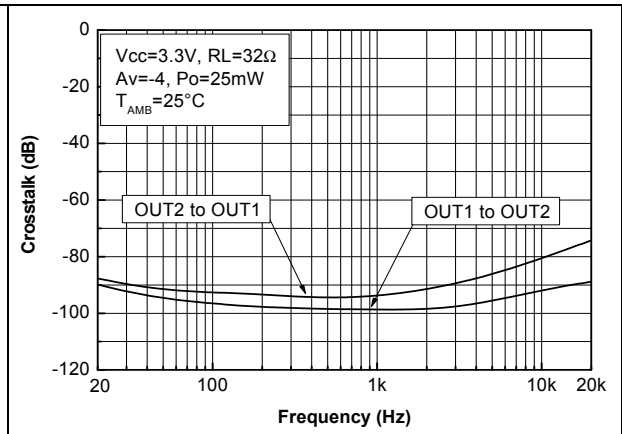

Figure 76. Crosstalk vs. frequency

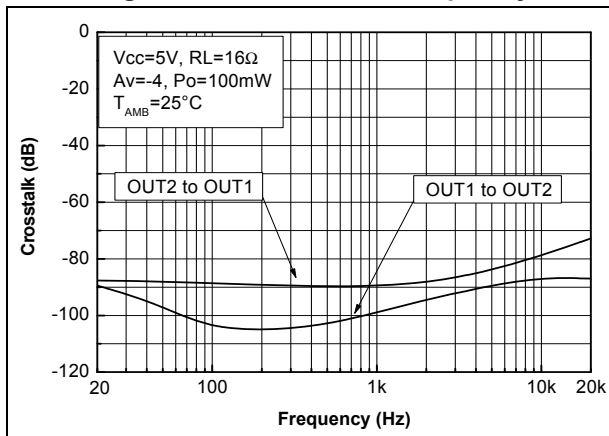
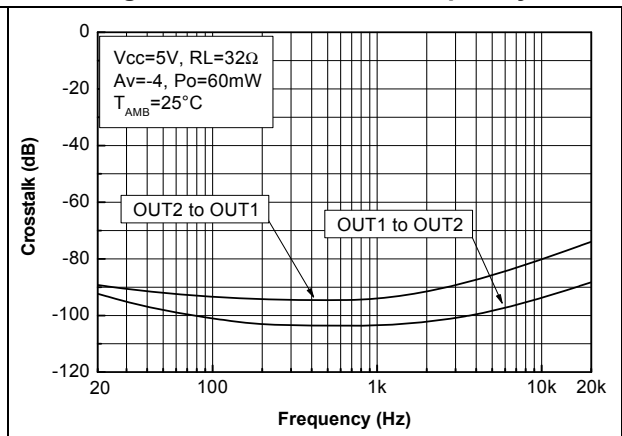

Figure 77. Crosstalk vs. frequency



4 Application information

4.1 Power dissipation and efficiency

Hypotheses:

- Voltage and current in the load are sinusoidal (V_{out} and I_{out}).
- Supply voltage is a pure DC source (V_{CC}).

Regarding the load we have:

$$V_{OUT} = V_{PEAK} \sin \omega t (V)$$

and

$$I_{OUT} = \frac{V_{OUT}}{R_L} (A)$$

and

$$P_{OUT} = \frac{V_{PEAK}^2}{2R_L} (A)$$

The average current delivered by the power supply voltage is:

$$I_{CC_{AVG}} = \frac{1}{2\pi} \int_0^{\pi} \frac{V_{PEAK}}{R_L} \sin(t) dt = \frac{V_{PEAK}}{\pi R_L} (A)$$

Figure 78. Current delivered by power supply voltage in single-ended configuration

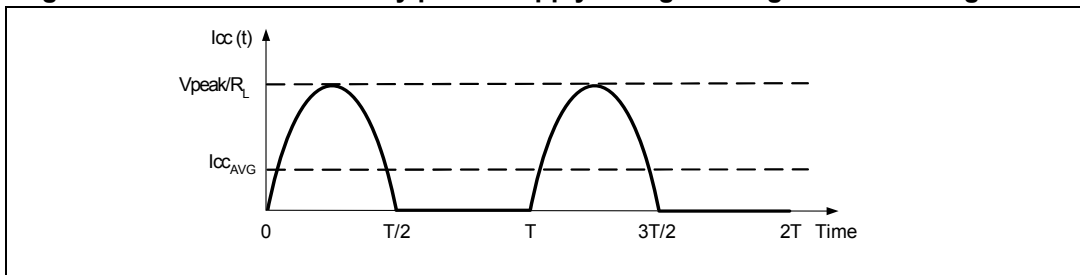

The power delivered by power supply voltage is:

$$P_{supply} = V_{CC} I_{CC_{AVG}} (W)$$

So, the power dissipation by each power amplifier is

$$P_{diss} = P_{supply} - P_{OUT} (W)$$

$$P_{diss} = \frac{\sqrt{2} V_{CC}}{\pi \sqrt{R_L}} \sqrt{P_{OUT}} - P_{OUT} (W)$$

and the maximum value is obtained when:

$$\frac{\partial P_{diss}}{\partial P_{OUT}} = 0$$

and its value is:

$$P_{\text{diss}_{\text{MAX}}} = \frac{V_{\text{CC}}^2}{\pi^2 R_L} \text{ (W)}$$

Note: This maximum value depends only on power supply voltage and load values.

The **efficiency** is the ratio between the output power and the power supply:

$$\eta = \frac{P_{\text{OUT}}}{P_{\text{supply}}} = \frac{\pi V_{\text{peak}}}{2V_{\text{CC}}}$$

The **maximum theoretical value** is reached when $V_{\text{peak}} = V_{\text{CC}}/2$, so

$$\eta = \frac{\pi}{4} = 78.5\%$$

4.2 Total power dissipation

The TS488/9 is stereo (dual channel) amplifier. It has two independent power amplifiers. Each amplifier produces heat due to its power dissipation. Therefore the maximum die temperature is the sum of each amplifier's maximum power dissipation. It is calculated as follows:

- $P_{\text{diss R}}$ = Power dissipation due to the right channel power amplifier.
- $P_{\text{diss L}}$ = Power dissipation due to the left channel power amplifier.
- Total $P_{\text{diss}} = P_{\text{diss R}} + P_{\text{diss L}}$ (W)

Typically, $P_{\text{diss R}}$ is equal to $P_{\text{diss L}}$, giving:

$$\text{Total } P_{\text{diss}} = 2P_{\text{diss R}} = 2P_{\text{diss L}}$$

$$\text{Total } P_{\text{diss}} = \frac{2\sqrt{2}V_{\text{CC}}}{\pi\sqrt{R_L}} \sqrt{P_{\text{OUT}}} - 2P_{\text{OUT}}$$

4.3 Lower cutoff frequency

The lower cutoff frequency F_{CL} of the amplifier depends on input capacitors C_{in} and output capacitors C_{out} .

The input capacitor C_{in} (output capacitor C_{out}) in serial with the input resistor R_{in} (load resistor R_L) of the amplifier is equivalent to a first order high pass filter. Assuming that F_{CL} is the lowest frequency to be amplified (with a 3 dB attenuation), the minimum value of the C_{in} (C_{out}) is:

$$C_{\text{in}} = \frac{1}{2\pi \cdot F_{\text{CL}} \cdot R_{\text{in}}}$$

$$C_{\text{out}} = \frac{1}{2\pi \cdot F_{\text{CL}} \cdot R_L}$$

Figure 79. Lower cutoff frequency vs. input capacitor

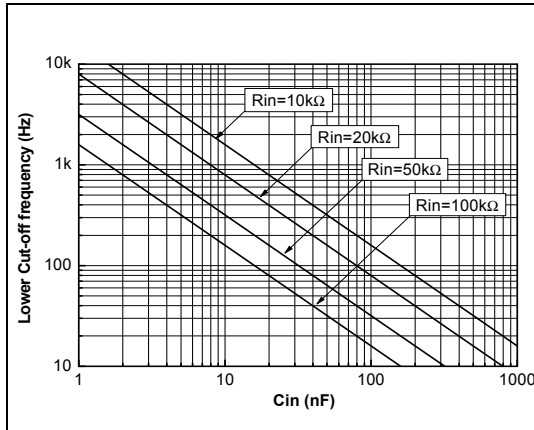
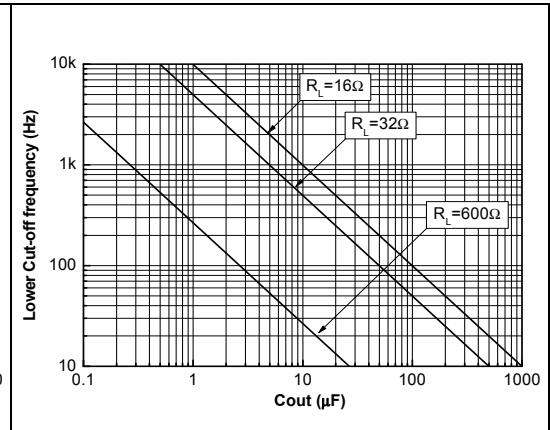

Figure 80. Lower cutoff frequency vs. output capacitor



Note: In case F_{CL} is kept the same for calculation, It must be taken in account that the 1st order high-pass filter on the input and the 1st order high-pass filter on the output create a 2nd order high-pass filter in the audio signal path with an attenuation 6 dB on F_{CL} and a roll-off 40db/decade.

4.4 Higher cutoff frequency

In the high-frequency region, you can limit the bandwidth by adding a capacitor C_{feed} in parallel with R_{feed} . It forms a low-pass filter with a -3 dB cutoff frequency F_{CH} . Assuming that F_{CH} is highest frequency to be amplified (with a 3 dB attenuation), the maximum value of C_{feed} is:

$$F_{CH} = \frac{1}{2\pi \cdot R_{feed} \cdot C_{feed}}$$

Figure 81. Higher cutoff frequency vs. feedback capacitor

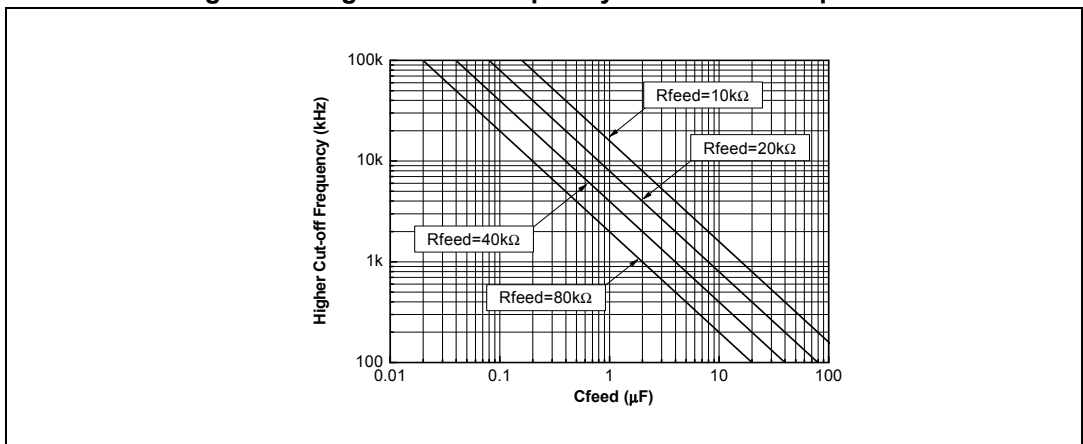

4.5 Gain setting

In the flat frequency response region (with no effect from C_{in} , C_{out} , C_{feed}), the output voltage is:

$$V_{OUT} = V_{IN} \cdot \left(-\frac{R_{feed}}{R_{in}} \right) = V_{IN} \cdot A_V$$

The gain A_V is:

$$A_V = -\frac{R_{feed}}{R_{in}}$$

4.6 Decoupling of the circuit

Two capacitors are needed to properly bypass the TS488 (TS489), a power supply capacitor C_s and a bias voltage bypass capacitor C_b .

C_s has a strong influence on the THD+N in the high frequency range (above 7kHz) and indirectly on the power supply disturbances. With 1 μ F, you can expect THD+N performance to be similar to the one shown in the datasheet. If C_s is lower than 1 μ F, the THD+N increases in the higher frequencies and disturbances on the power supply rail are less filtered. On the contrary, if C_s is higher than 1 μ F, the disturbances on the power supply rail are more filtered.

C_b has an influence on the THD+N in the low frequency range. Its value is critical on the PSRR with grounded inputs in the lower frequencies:

- If C_b is lower than 1 μ F, the THD+N improves and the PSRR worsens.
- If C_b is higher than 1 μ F, the benefit on the THD+N and PSRR is small.

Note: The input capacitor C_{in} also has a significant effect on the PSRR at lower frequencies. The lower the value of C_{in} , the higher the PSRR.

4.7 Standby mode

When the standby mode is activated an internal circuit of the TS488 (TS489) is charged (see [Figure 82](#)). A time required to change the internal circuit is a few microseconds.

Figure 82. Internal equivalent schematic of the TS488 (TS489) in standby mode

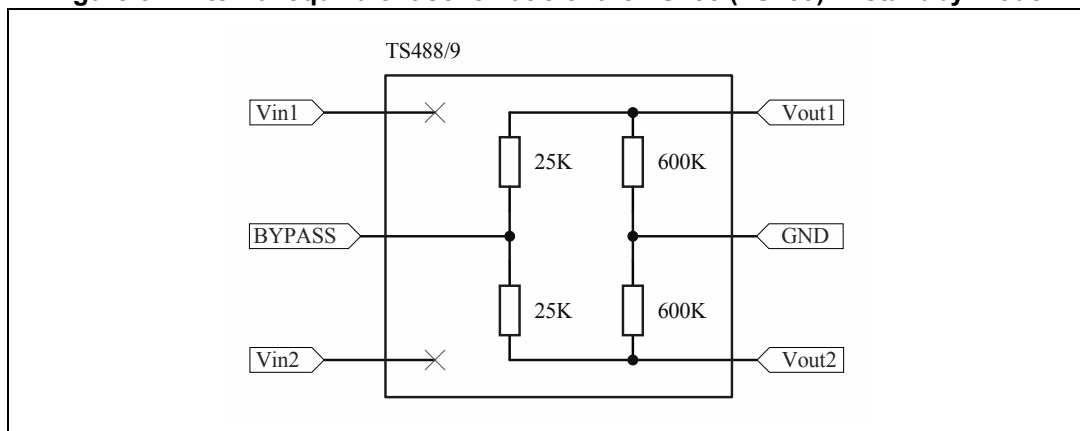

4.8 Wake-up time

When the standby is released to put the device ON, the bypass capacitor C_b is charged immediately. As C_b is directly linked to the bias of the amplifier, the bias will not work properly until the C_b voltage is correct. The time to reach this voltage plus a time delay of 20 ms (pop precaution) is called the wake-up time or t_{WU} ; it is specified in the electrical characteristics table with $C_b = 1\mu F$.

If C_b has a value other than $1\mu F$, t_{WU} can be calculated by applying the following formulas or can be read directly from [Figure 83](#).

$$t_{WU} = \frac{C_b \cdot 2.5}{0.03125} + 20 \quad [\text{ms}; \mu\text{F}]$$

Figure 83. Typical wake-up time vs. bypass capacitance

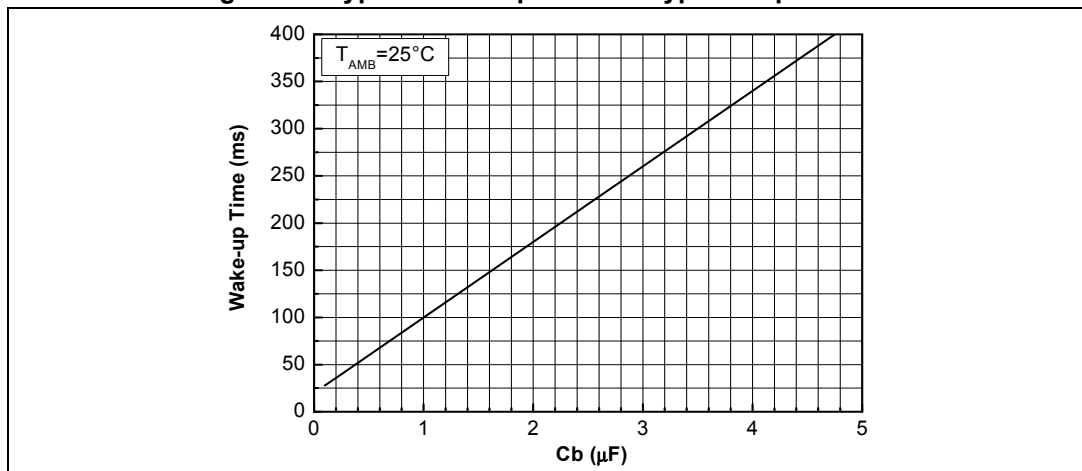

Note: It is assumed that the C_b voltage is equal to 0V. If the C_b voltage is not equal to 0V, the wake-up time is shorter.

4.9 POP performance

Pop performance is closely related to the size of the input capacitor C_{in} . The size of C_{in} is dependent on the lower cutoff frequency and PSRR values requested.

In order to reach low pop, C_{in} must be charged to $V_{CC}/2$ in less than 20 ms. To follow this rule, the equivalent input constant time ($R_{in}C_{in}$) should be less than 6.7 ms:

$$\tau_{in} = R_{in} \times C_{in} < 0.0067 \text{ (s)}$$

Example calculation:

In the typical application schematic R_{in} is 20 k Ω and C_{in} is 330 nF. The lower cutoff frequency (-3 db attenuation) is given by the following formula:

$$F_{CL} = \frac{1}{2\pi \cdot R_{in} \cdot C_{in}}$$

With the values above, the result is $F_{CL} = 25 \text{ Hz}$.

In this case, $\tau_{in} = R_{in} \times C_{in} = 6.6 \text{ ms}$.

This value is sufficient with regard to the previous formula, thus we can state that the pop is imperceptible.

4.10 Connecting the headphones

Generally headphones are connected using jack connectors. To prevent a pop in the headphones when plugging in the jack, a pulldown resistor should be connected in parallel with each headphone output. This allows the capacitors C_{out} to be charged even when the headphones are not plugged in.

Pulldown resistors with a value of 1 k Ω are high enough to be a negligible load, and low enough to charge the capacitors C_{out} in less than one second.

Note: The pop&click reduction circuitry works properly only when both channels have the same value for the external components C_{in} , C_{out} , R_{load} and $R_{pulldown}$.

5 Package information

In order to meet environmental requirements, ST offers these devices in different grades of ECOPACK[®] packages, depending on their level of environmental compliance. ECOPACK[®] specifications, grade definitions and product status are available at: www.st.com. ECOPACK[®] is an ST trademark.

5.1 MiniSO-8 package information

miniSO-8 MECHANICAL DATA

DIM.	mm.			inch		
	MIN.	TYP.	MAX.	MIN.	TYP.	MAX.
A			1.1			0.043
A1	0.05	0.10	0.15	0.002	0.004	0.006
A2	0.78	0.86	0.94	0.031	0.031	0.037
b	0.25	0.33	0.40	0.010	0.13	0.013
c	0.13	0.18	0.23	0.005	0.007	0.009
D	2.90	3.00	3.10	0.114	0.118	0.122
E	4.75	4.90	5.05	0.187	0.193	0.199
E1	2.90	3.00	3.10	.0114	0.118	0.122
e		0.65			0.026	
K	0°		6°	0°		6°
L	0.40	0.55	0.70	0.016	0.022	0.028
L1			0.10			0.004

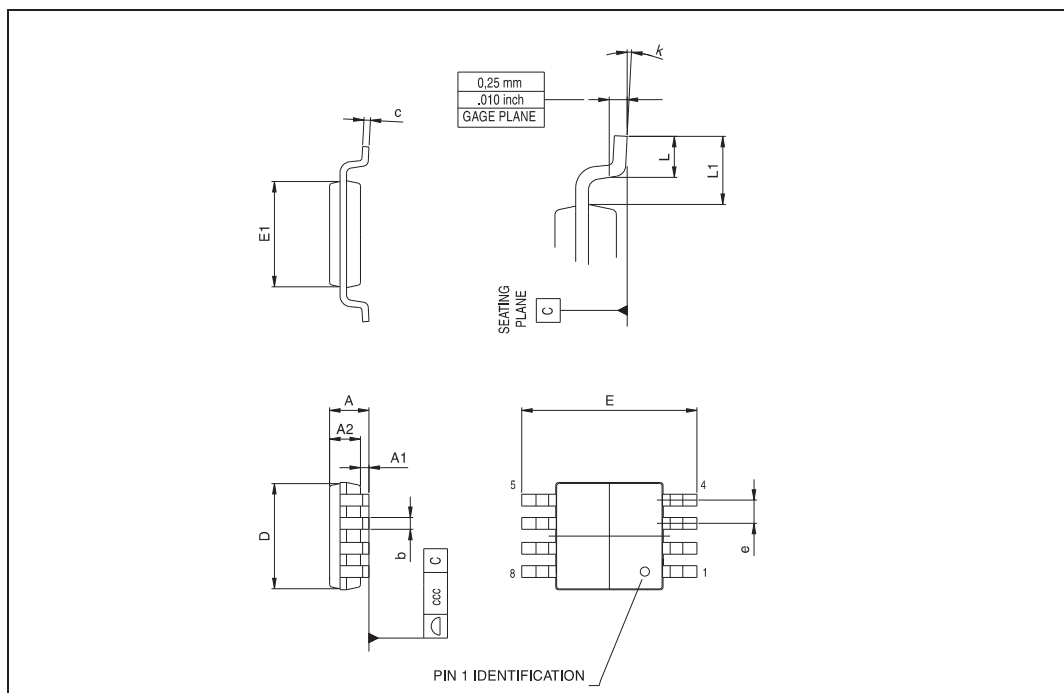

5.2 DFN8 package information

Figure 84. DFN8 (2 x 2 mm, pitch 0.5 mm) package outline

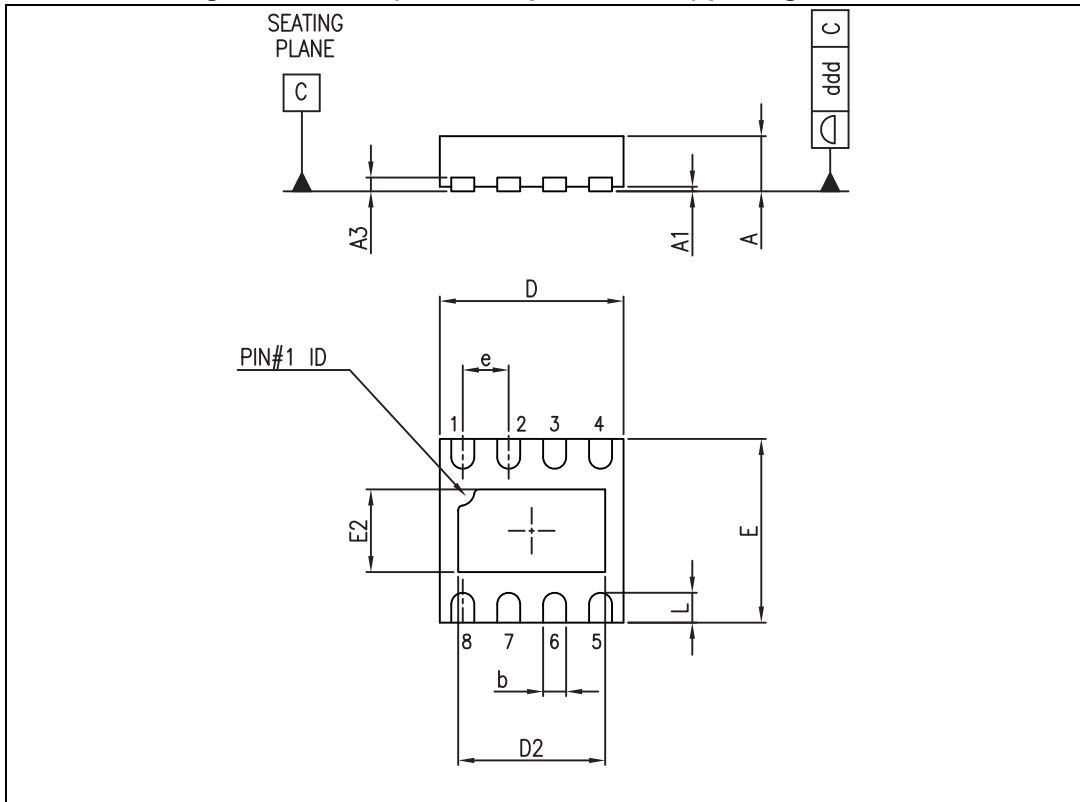

Table 8. DFN8 (2 x 2 mm, pitch 0.5 mm) package mechanical data

Ref.	Dimensions					
	Millimeters			Inches		
	Min.	Typ.	Max.	Min.	Typ.	Max.
A	0.51	0.55	0.60	0.020	0.022	0.024
A1			0.05			0.002
A3		0.15			0.006	
b	0.18	0.25	0.30	0.007	0.010	0.012
D	1.85	2.00	2.15	0.073	0.079	0.085
D2	1.45	1.60	1.70	0.057	0.063	0.067
E	1.85	2.00	2.15	0.073	0.079	0.085
E2	0.75	0.90	1.00	0.030	0.035	0.040
e		0.50			0.020	
L			0.425			0.017
ddd			0.08			0.003

6 Ordering information

Table 9. Order codes

Order code	Temperature range	Package	Packing	Marking
TS488IST	-40 °C to +85 °C	MiniSO-8	Tape & reel	K488
TS488IQT		DFN8		K88

7 Revision history

Table 10. Document revision history

Date	Revision	Changes
2-Jan-2006	1	First release corresponding to the product preview version.
1-Feb-2006	2	Removal of typical application schematic on first page (it appears in Figure 1 on page 3). Minor grammatical and formatting corrections throughout.
4-Aug-2006	3	Update of marking. Update of DFN8 package height. Editorial update.
15-Sep-2006	4	Revision corresponding to the release to production of the TS488 - TS489.
14-May-2012	5	Removed obsolete part numbers TS489IQT and TS489IST from the cover page and Table 8: Order codes. Updated ECOPACK® text in Section 5: Package mechanical data. Updated package in Section 5.2: DFN8 package.
13-Apr-2017	6	Updated Section 5.2: DFN8 package information : "L" dimension changed from 0.5 mm to 0.425 mm. Minor changes throughout the document.

IMPORTANT NOTICE – PLEASE READ CAREFULLY

STMicroelectronics NV and its subsidiaries (“ST”) reserve the right to make changes, corrections, enhancements, modifications, and improvements to ST products and/or to this document at any time without notice. Purchasers should obtain the latest relevant information on ST products before placing orders. ST products are sold pursuant to ST’s terms and conditions of sale in place at the time of order acknowledgement.

Purchasers are solely responsible for the choice, selection, and use of ST products and ST assumes no liability for application assistance or the design of Purchasers’ products.

No license, express or implied, to any intellectual property right is granted by ST herein.

Resale of ST products with provisions different from the information set forth herein shall void any warranty granted by ST for such product.

ST and the ST logo are trademarks of ST. All other product or service names are the property of their respective owners.

Information in this document supersedes and replaces information previously supplied in any prior versions of this document.

© 2017 STMicroelectronics – All rights reserved