



## TS4997

### 2 x 1W differential input stereo audio amplifier with programmable 3D effects

#### Features

- Operating range from  $V_{CC} = 2.7V$  to  $5.5V$
- 1W output power per channel @  $V_{CC} = 5V$ , THD+N=1%,  $R_L = 8\Omega$
- Ultra low standby consumption: 10nA typ.
- 80dB PSRR @ 217Hz with grounded inputs
- High SNR: 106dB(A) typ.
- Fast startup time: 45ms typ.
- Pop&click-free circuit
- Dedicated standby pin per channel
- Lead-free QFN16 4x4mm package

#### Applications

- Cellular mobile phones
- Notebook and PDA computers
- LCD monitors and TVs
- Portable audio devices

#### Description

The TS4997 is designed for top-class stereo audio applications. Thanks to its compact and power-dissipation efficient QFN16 package with exposed pad, it suits a variety of applications.

With a BTL configuration, this audio power amplifier is capable of delivering 1W per channel of continuous RMS output power into an  $8\Omega$  load @ 5V.

3D effects enhancement is programmed through a two digital input pin interface that allows more flexibility on each output audio sound channel.

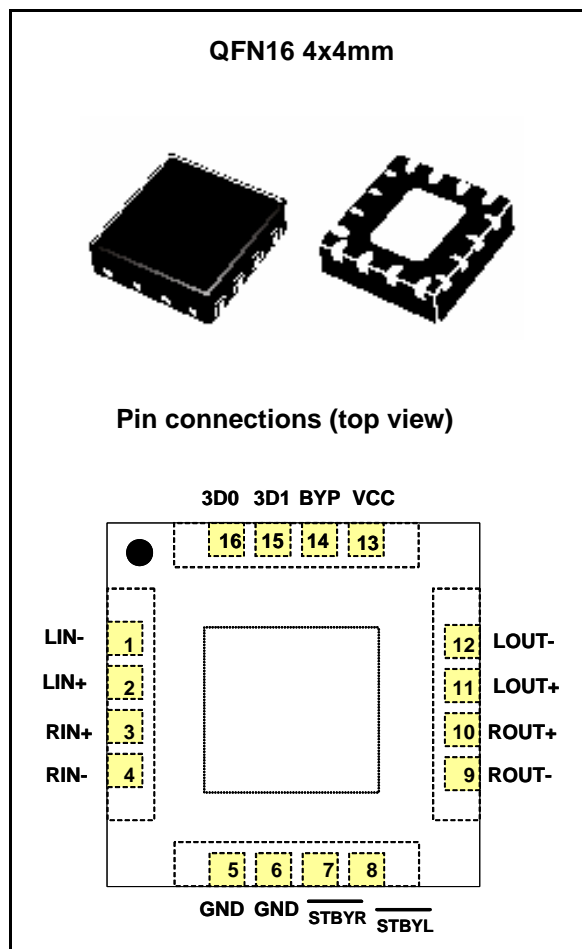

Each output channel (left and right), also has its own external controlled standby mode pin to reduce the supply current to less than 10nA per channel. The device also features an internal thermal shutdown protection.

The gain of each channel can be configured by external gain setting resistors.

# Contents

<b>1</b>	<b>Typical application schematics</b>	<b>3</b>
<b>2</b>	<b>Absolute maximum ratings</b>	<b>4</b>
<b>3</b>	<b>Electrical characteristics</b>	<b>5</b>
<b>4</b>	<b>Application information</b>	<b>20</b>
4.1	General description	20
4.2	Differential configuration principle	20
4.3	Gain in typical application schematic	20
4.4	Common mode feedback loop limitations	21
4.5	Low frequency response	22
4.6	3D effect enhancement	22
4.7	Power dissipation and efficiency	23
4.8	Footprint recommendation	25
4.9	Decoupling of the circuit	25
4.10	Standby control and wake-up time $t_{WU}$	26
4.11	Shutdown time	27
4.12	Pop performance	27
4.13	Single-ended input configuration	27
4.14	Notes on PSRR measurement	28
<b>5</b>	<b>QFN16 package information</b>	<b>30</b>
<b>6</b>	<b>Ordering information</b>	<b>32</b>
<b>7</b>	<b>Revision history</b>	<b>33</b>

# 1 Typical application schematics

Figure 1 shows a typical application for the TS4997 with a gain of +6dB set by the input resistors.

Figure 1. Typical application schematics

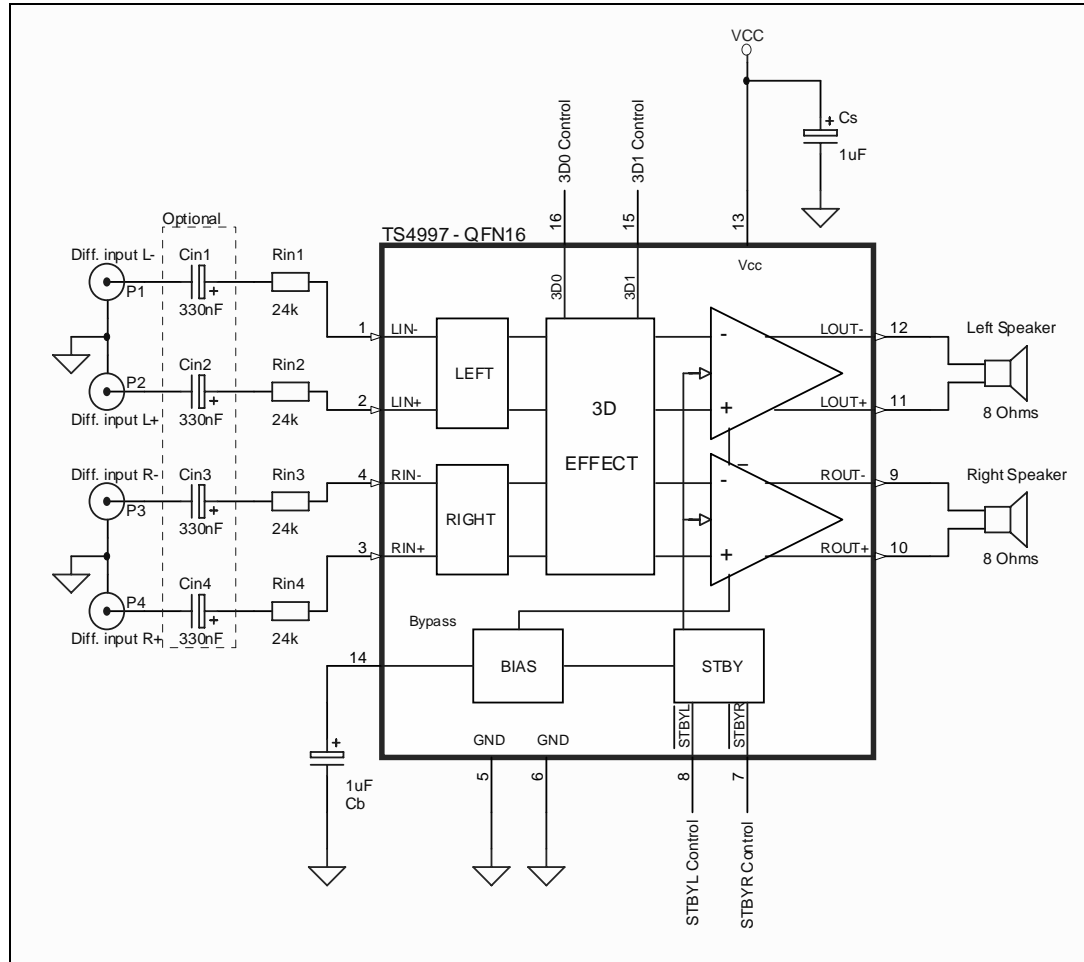

Table 1. External component descriptions

Components	Functional description
$R_{IN}$	Input resistors that set the closed loop gain in conjunction with a fixed internal feedback resistor ( $Gain = R_{feed}/R_{IN}$ , where $R_{feed} = 50k\Omega$ ).
$C_{IN}$	Input coupling capacitors that block the DC voltage at the amplifier input terminal. Thanks to common mode feedback, these input capacitors are optional. However, if they are added, they form with $R_{IN}$ a 1st order high pass filter with -3dB cut-off frequency ( $f_{cut-off} = 1 / (2 \times \pi \times R_{IN} \times C_{IN})$ ).
$C_S$	Supply bypass capacitors that provides power supply filtering.
$C_B$	Bypass pin capacitor that provides half supply filtering.

## 2 Absolute maximum ratings

**Table 2. Absolute maximum ratings**

Symbol	Parameter	Value	Unit
$V_{CC}$	Supply voltage <sup>(1)</sup>	6	V
$V_i$	Input voltage <sup>(2)</sup>	GND to $V_{CC}$	V
$T_{oper}$	Operating free air temperature range	-40 to + 85	°C
$T_{stg}$	Storage temperature	-65 to +150	°C
$T_j$	Maximum junction temperature	150	°C
$R_{thja}$	Thermal resistance junction to ambient	120	°C/W
$P_d$	Power dissipation	Internally limited	
ESD	Human body model <sup>(3)</sup>	2	kV
	Digital pins STBYL, STBYR, 3D0, 3D1	1.5	
ESD	Machine model	200	V
	Latch-up immunity	200	mA

1. All voltage values are measured with respect to the ground pin.
2. The magnitude of the input signal must never exceed  $V_{CC} + 0.3V / GND - 0.3V$ .
3. All voltage values are measured from each pin with respect to supplies.

**Table 3. Operating conditions**

Symbol	Parameter	Value	Unit
$V_{CC}$	Supply voltage	2.7 to 5.5	V
$V_{ICM}$	Common mode input voltage range	GND to $V_{CC} - 1V$	V
$V_{IL}$	3D0 - 3D1 maximum low input voltage	0.4	V
$V_{IH}$	3D0 - 3D1 minimum high input voltage	1.3	V
$V_{STBY}$	Standby voltage input:	$1.3 \leq V_{STBY} \leq V_{CC}$ $GND \leq V_{STBY} \leq 0.4$	V
	Device ON		
	Device OFF		
$R_L$	Load resistor	$\geq 4$	$\Omega$
$R_{OUT/GND}$	Output resistor to GND ( $V_{STBY} = GND$ )	$\geq 1$	M $\Omega$
TSD	Thermal shutdown temperature	150	°C
$R_{thja}$	Thermal resistance junction to ambient		°C/W
	QFN16 <sup>(1)</sup>	45	
	QFN16 <sup>(2)</sup>	85	

1. When mounted on a 4-layer PCB with vias.
2. When mounted on a 2-layer PCB with vias.

### 3 Electrical characteristics

**Table 4.**  $V_{CC} = +5V$ ,  $GND = 0V$ ,  $T_{amb} = 25^{\circ}C$  (unless otherwise specified)

Symbol	Parameter	Min.	Typ.	Max.	Unit
$I_{CC}$	Supply current No input signal, no load, left and right channel active		7.4	9.6	mA
$I_{STBY}$	Standby current <sup>(1)</sup> No input signal, $V_{STBYL} = GND$ , $V_{STBYR} = GND$ , $R_L = 8\Omega$		10	2000	nA
$V_{oo}$	Output offset voltage No input signal, $R_L = 8\Omega$		1	35	mV
$P_o$	Output power THD = 1% Max, $F = 1kHz$ , $R_L = 8\Omega$	800	1000		mW
THD + N	Total harmonic distortion + noise $P_o = 700mW_{rms}$ , $G = 6dB$ , $R_L = 8\Omega$ , $20Hz \leq F \leq 20kHz$		0.5		%
PSRR	Power supply rejection ratio <sup>(2)</sup> , inputs grounded $R_L = 8\Omega$ , $G = 6dB$ , $C_b = 1\mu F$ , $V_{ripple} = 200mV_{pp}$ , 3D effect off $F = 217Hz$ $F = 1kHz$		80 75		dB
CMRR	Common mode rejection ratio <sup>(3)</sup> $R_L = 8\Omega$ , $G = 6dB$ , $C_b = 1\mu F$ , $V_{incm} = 200mV_{pp}$ , 3D effect off $F = 217Hz$ $F = 1kHz$		57 57		dB
SNR	Signal-to-noise ratio A-weighted, $G = 6dB$ , $C_b = 1\mu F$ , $R_L = 8\Omega$ , 3D effect off (THD + N $\leq 0.5\%$ , $20Hz < F < 20kHz$ )		108		dB
Crosstalk	Channel separation, $R_L = 8\Omega$ , $G = 6dB$ , 3D effect off $F = 1kHz$ $F = 20Hz$ to $20kHz$		105 80		dB
$V_N$	Output voltage noise, $F = 20Hz$ to $20kHz$ , $R_L = 8\Omega$ , $G=6dB$ $C_b = 1\mu F$ , 3D effect off Unweighted A-weighted		15 10		$\mu V_{rms}$
Gain	Gain value ( $R_{IN}$ in $k\Omega$ )	$\frac{40k\Omega}{R_{IN}}$	$\frac{50k\Omega}{R_{IN}}$	$\frac{60k\Omega}{R_{IN}}$	V/V
$t_{WU}$	Wake-up time ( $C_b = 1\mu F$ )		46		ms
$t_{STBY}$	Standby time ( $C_b = 1\mu F$ )		10		$\mu s$
$\Phi_M$	Phase margin at unity gain $R_L = 8\Omega$ , $C_L = 500pF$		65		Degrees
GM	Gain margin, $R_L = 8\Omega$ , $C_L = 500pF$		15		dB
GBP	Gain bandwidth product, $R_L = 8\Omega$		1.5		MHz

1. Standby mode is active when  $V_{STBY}$  is tied to GND.

2. Dynamic measurements -  $20 \cdot \log(rms(V_{out})/rms(V_{ripple}))$ .  $V_{ripple}$  is the sinusoidal signal superimposed upon  $V_{CC}$ .

3. Dynamic measurements -  $20 \cdot \log(rms(V_{out})/rms(V_{incm}))$ .

Table 5.  $V_{CC} = +3.3V$ ,  $GND = 0V$ ,  $T_{amb} = 25^{\circ}C$  (unless otherwise specified)

Symbol	Parameter	Min.	Typ.	Max.	Unit
$I_{CC}$	Supply current No input signal, no load, left and right channel active		6.6	8.6	mA
$I_{STBY}$	Standby current <sup>(1)</sup> No input signal, $V_{STBYL} = GND$ , $V_{STBYR} = GND$ , $R_L = 8\Omega$		10	2000	nA
$V_{oo}$	Output offset voltage No input signal, $R_L = 8\Omega$		1	35	mV
$P_o$	Output power THD = 1% Max, $F = 1kHz$ , $R_L = 8\Omega$	370	460		mW
THD + N	Total harmonic distortion + noise $P_o = 300mW_{rms}$ , $G = 6dB$ , $R_L = 8\Omega$ , $20Hz \leq F \leq 20kHz$		0.5		%
PSRR	Power supply rejection ratio <sup>(2)</sup> , inputs grounded $R_L = 8\Omega$ , $G = 6dB$ , $C_b = 1\mu F$ , $V_{ripple} = 200mV_{pp}$ , 3D effect off $F = 217Hz$ $F = 1kHz$		80 75		dB
CMRR	Common mode rejection ratio <sup>(3)</sup> $R_L = 8\Omega$ , $G = 6dB$ , $C_b = 1\mu F$ , $V_{incm} = 200mV_{pp}$ , 3D effect off $F = 217Hz$ $F = 1kHz$		57 57		dB
SNR	Signal-to-noise ratio A-weighted, $G = 6dB$ , $C_b = 1\mu F$ , $R_L = 8\Omega$ , 3D effect off (THD + N $\leq 0.5\%$ , $20Hz < F < 20kHz$ )		104		dB
Crosstalk	Channel separation, $R_L = 8\Omega$ , $G = 6dB$ , 3D effect off $F = 1kHz$ $F = 20Hz$ to $20kHz$		105 80		dB
$V_N$	Output voltage noise, $F = 20Hz$ to $20kHz$ , $R_L = 8\Omega$ , $G=6dB$ $C_b = 1\mu F$ , 3D effect off Unweighted A-weighted		15 10		$\mu V_{rms}$
Gain	Gain value ( $R_{IN}$ in $k\Omega$ )	$\frac{40k\Omega}{R_{IN}}$	$\frac{50k\Omega}{R_{IN}}$	$\frac{60k\Omega}{R_{IN}}$	V/V
$t_{WU}$	Wake-up time ( $C_b = 1\mu F$ )		47		ms
$t_{STBY}$	Standby time ( $C_b = 1\mu F$ )		10		$\mu s$
$\Phi_M$	Phase margin at unity gain $R_L = 8\Omega$ , $C_L = 500pF$		65		Degrees
GM	Gain margin $R_L = 8\Omega$ , $C_L = 500pF$		15		dB
GBP	Gain bandwidth product $R_L = 8\Omega$		1.5		MHz

1. Standby mode is active when  $V_{STBY}$  is tied to GND.

2. Dynamic measurements -  $20 \cdot \log(\text{rms}(V_{out})/\text{rms}(V_{ripple}))$ .  $V_{ripple}$  is the sinusoidal signal superimposed upon  $V_{CC}$ .

3. Dynamic measurements -  $20 \cdot \log(\text{rms}(V_{out})/\text{rms}(V_{incm}))$ .

Table 6.  $V_{CC} = +2.7V$ ,  $GND = 0V$ ,  $T_{amb} = 25^{\circ}C$  (unless otherwise specified)

Symbol	Parameter	Min.	Typ.	Max.	Unit
$I_{CC}$	Supply current No input signal, no load, left and right channel active		6.2	8.1	mA
$I_{STBY}$	Standby current <sup>(1)</sup> No input signal, $V_{STBYL} = GND$ , $V_{STBYR} = GND$ , $R_L = 8\Omega$		10	2000	nA
$V_{oo}$	Output offset voltage No input signal, $R_L = 8\Omega$		1	35	mV
$P_o$	Output power THD = 1% Max, $F = 1kHz$ , $R_L = 8\Omega$	220	295		mW
THD + N	Total harmonic distortion + noise $P_o = 200mW_{rms}$ , $G = 6dB$ , $R_L = 8\Omega$ , $20Hz \leq F \leq 20kHz$		0.5		%
PSRR	Power supply rejection ratio <sup>(2)</sup> , inputs grounded $R_L = 8\Omega$ , $G = 6dB$ , $C_b = 1\mu F$ , $V_{ripple} = 200mV_{pp}$ , 3D effect off $F = 217Hz$ $F = 1kHz$		76 73		dB
CMRR	Common mode rejection ratio <sup>(3)</sup> $R_L = 8\Omega$ , $G = 6dB$ , $C_b = 1\mu F$ , $V_{in cm} = 200mV_{pp}$ , 3D effect off $F = 217Hz$ $F = 1kHz$		57 57		dB
SNR	Signal-to-noise ratio A-weighted, $G = 6dB$ , $C_b = 1\mu F$ , $R_L = 8\Omega$ , 3D effect off (THD + N $\leq 0.5\%$ , $20Hz < F < 20kHz$ )		102		dB
Crosstalk	Channel separation, $R_L = 8\Omega$ , $G = 6dB$ , 3D effect off $F = 1kHz$ $F = 20Hz$ to $20kHz$		105 80		dB
$V_N$	Output voltage noise, $F = 20Hz$ to $20kHz$ , $R_L = 8\Omega$ , $G=6dB$ $C_b = 1\mu F$ , 3D effect off Unweighted A-weighted		15 10		$\mu V_{rms}$
Gain	Gain value ( $R_{IN}$ in $k\Omega$ )	$\frac{40k\Omega}{R_{IN}}$	$\frac{50k\Omega}{R_{IN}}$	$\frac{60k\Omega}{R_{IN}}$	V/V
$t_{WU}$	Wake-up time ( $C_b = 1\mu F$ )		46		ms
$t_{STBY}$	Standby time ( $C_b = 1\mu F$ )		10		$\mu s$
$\Phi_M$	Phase margin at unity gain $R_L = 8\Omega$ , $C_L = 500pF$		65		Degrees
GM	Gain margin $R_L = 8\Omega$ , $C_L = 500pF$		15		dB
GBP	Gain bandwidth product $R_L = 8\Omega$		1.5		MHz

1. Standby mode is active when  $V_{STBY}$  is tied to GND.

2. Dynamic measurements -  $20 \cdot \log(\text{rms}(V_{out})/\text{rms}(V_{ripple}))$ .  $V_{ripple}$  is the sinusoidal signal superimposed upon  $V_{CC}$ .

3. Dynamic measurements -  $20 \cdot \log(\text{rms}(V_{out})/\text{rms}(V_{in cm}))$ .

**Table 7. Index of graphics**

<b>Description</b>	<b>Figure</b>	<b>Page</b>
THD+N vs. output power	<a href="#">Figure 2 to 13</a>	<a href="#">page 9 to page 10</a>
THD+N vs. frequency	<a href="#">Figure 14 to 19</a>	<a href="#">page 11</a>
PSRR vs. frequency	<a href="#">Figure 20 to 28</a>	<a href="#">page 12 to page 13</a>
PSRR vs. common mode input voltage	<a href="#">Figure 29</a>	<a href="#">page 13</a>
CMRR vs. frequency	<a href="#">Figure 30 to 35</a>	<a href="#">page 13 to page 14</a>
CMRR vs. common mode input voltage	<a href="#">Figure 36</a>	<a href="#">page 14</a>
Crosstalk vs. frequency	<a href="#">Figure 37 to 39</a>	<a href="#">page 14 to page 15</a>
SNR vs. power supply voltage	<a href="#">Figure 40 to 45</a>	<a href="#">page 15 to page 16</a>
Differential DC output voltage vs. common mode input voltage	<a href="#">Figure 46 to 48</a>	<a href="#">page 16</a>
Current consumption vs. power supply voltage	<a href="#">Figure 49</a>	<a href="#">page 16</a>
Current consumption vs. standby voltage	<a href="#">Figure 50 to 52</a>	<a href="#">page 17</a>
Standby current vs. power supply voltage	<a href="#">Figure 53</a>	<a href="#">page 17</a>
Frequency response	<a href="#">Figure 54 to 56</a>	<a href="#">page 17 to page 18</a>
Output power vs. load resistance	<a href="#">Figure 57</a>	<a href="#">page 18</a>
Output power vs. power supply voltage	<a href="#">Figure 58 to 59</a>	<a href="#">page 18</a>
Power dissipation vs. output power	<a href="#">Figure 60 to 62</a>	<a href="#">page 18 to page 19</a>
Power derating curves	<a href="#">Figure 63</a>	<a href="#">page 19</a>



Figure 2. THD+N vs. output power

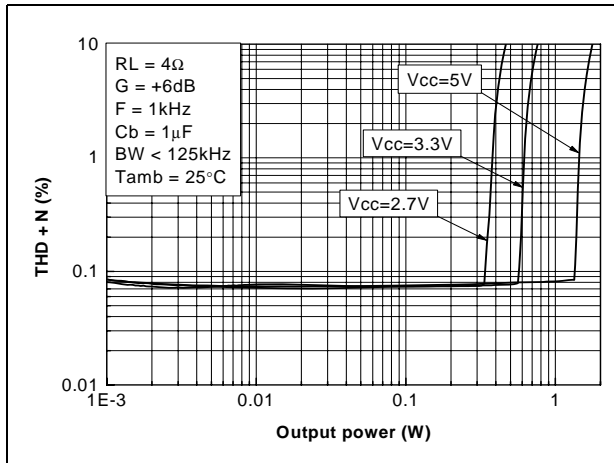

Figure 3. THD+N vs. output power

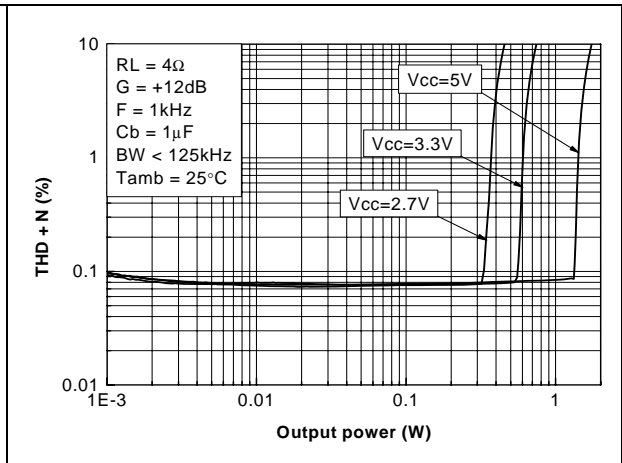

Figure 4. THD+N vs. output power

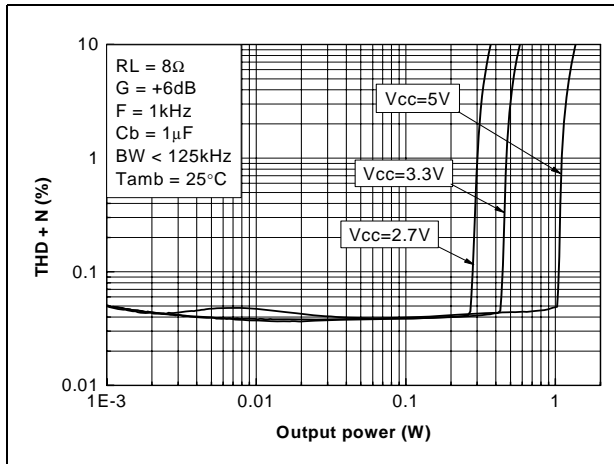

Figure 5. THD+N vs. output power

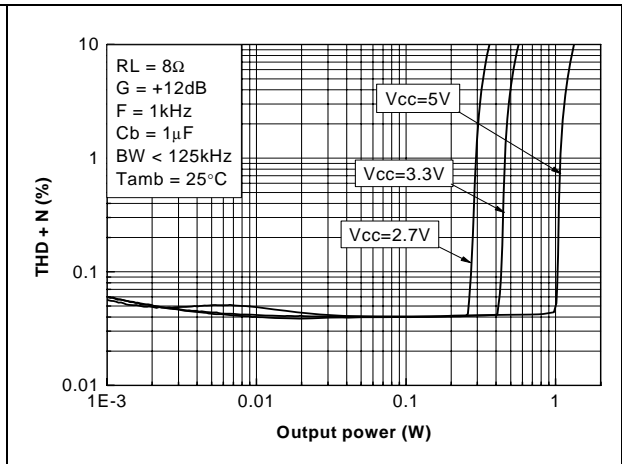

Figure 6. THD+N vs. output power

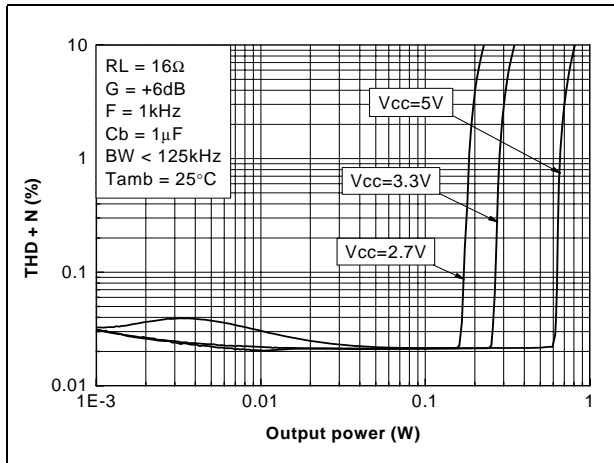

Figure 7. THD+N vs. output power

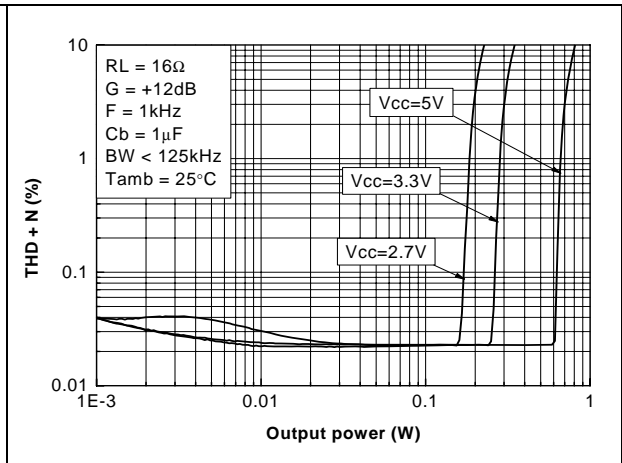

Figure 8. THD+N vs. output power

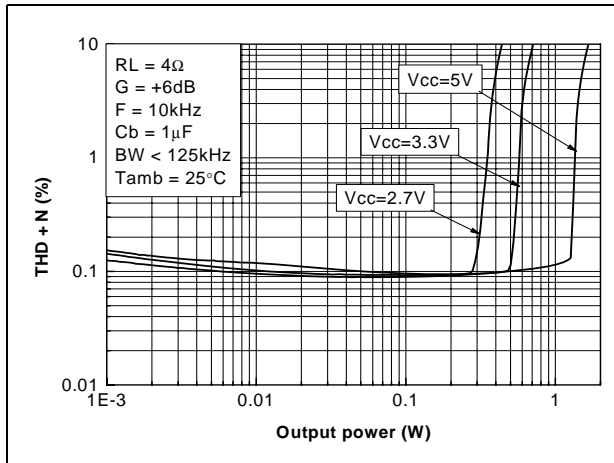

Figure 9. THD+N vs. output power

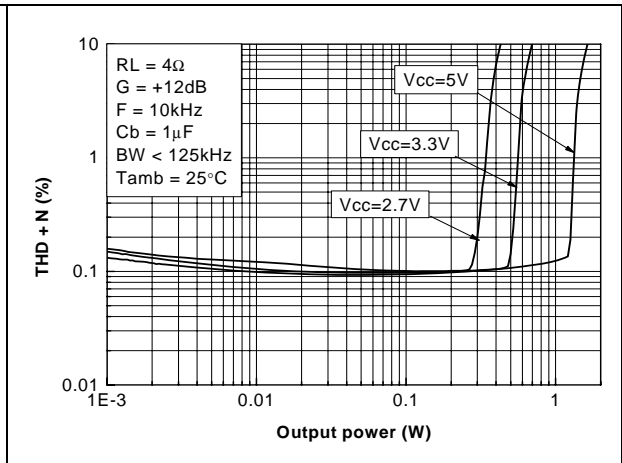

Figure 10. THD+N vs. output power

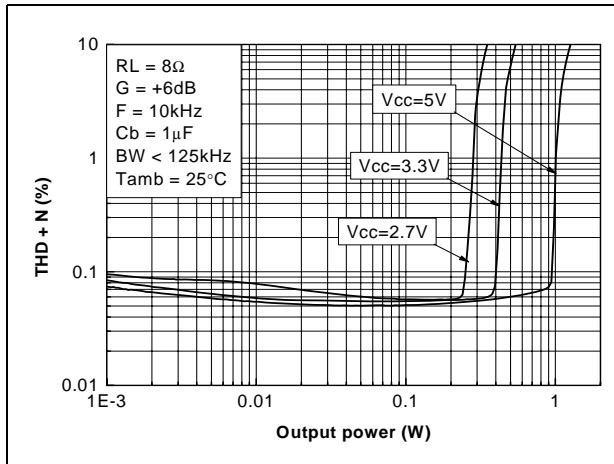

Figure 11. THD+N vs. output power

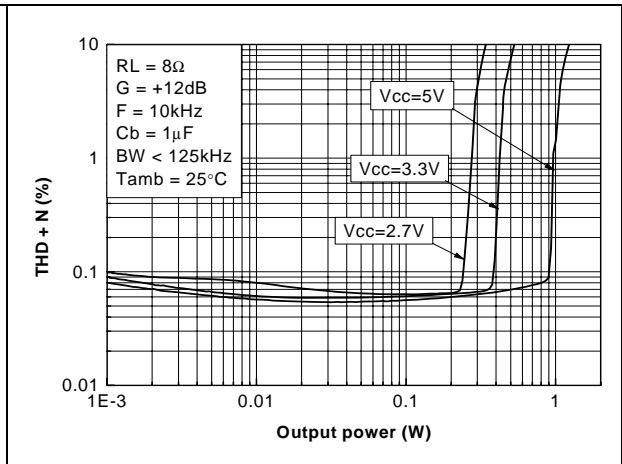

Figure 12. THD+N vs. output power

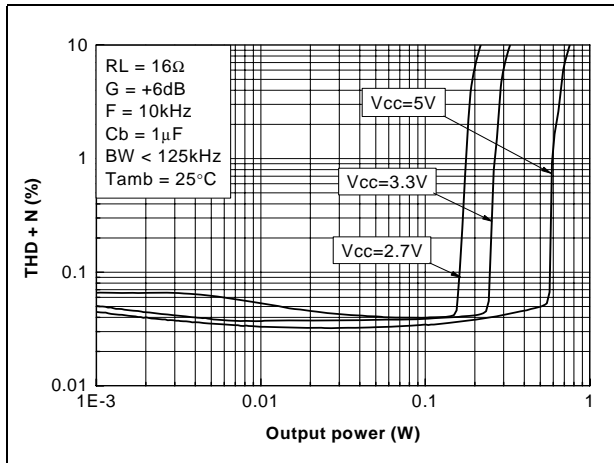

Figure 13. THD+N vs. output power

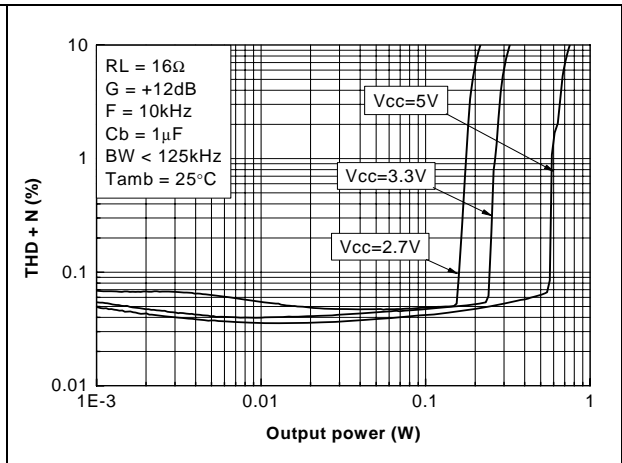

Figure 14. THD+N vs. frequency

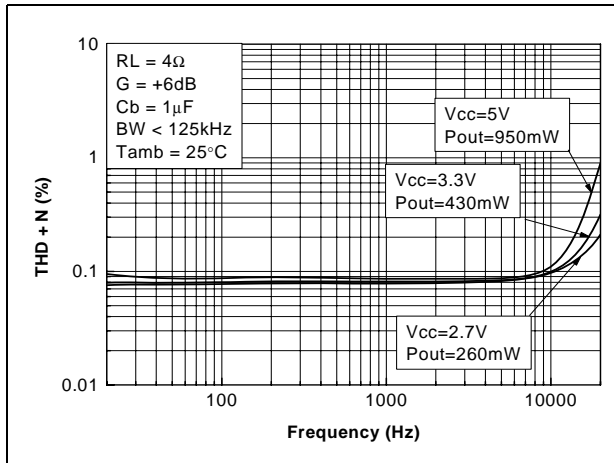

Figure 15. THD+N vs. frequency

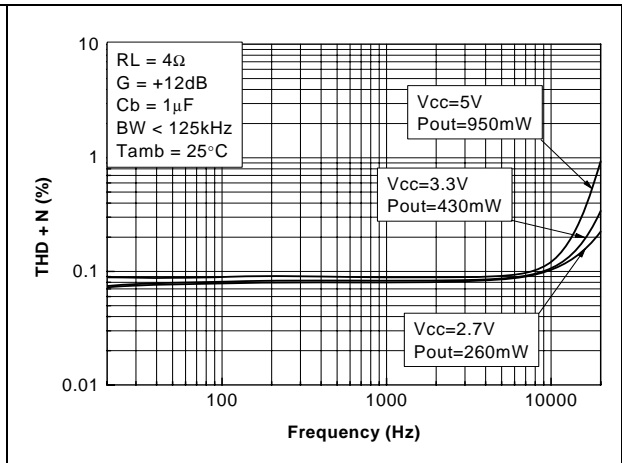

Figure 16. THD+N vs. frequency

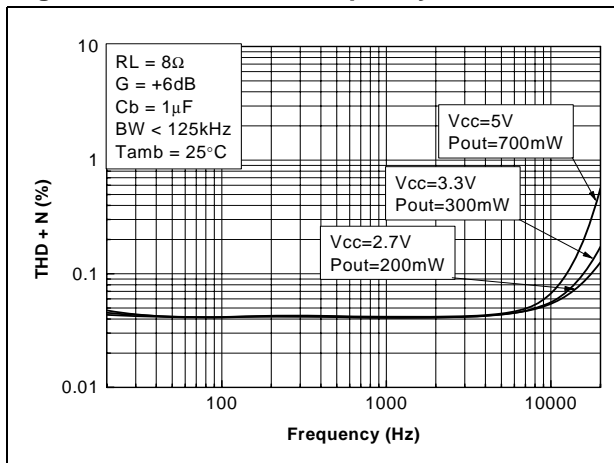

Figure 17. THD+N vs. frequency

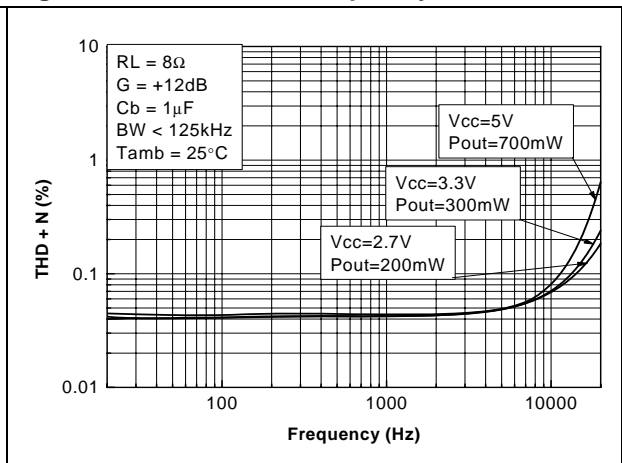

Figure 18. THD+N vs. frequency

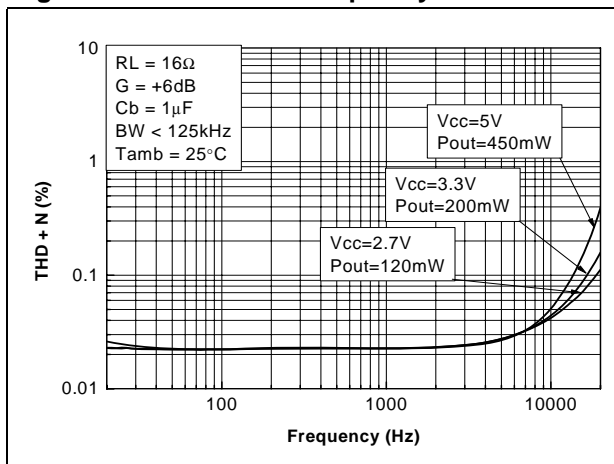

Figure 19. THD+N vs. frequency

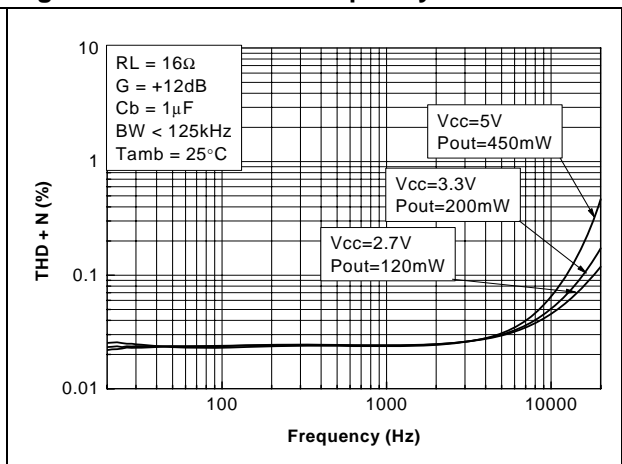

Figure 20. PSRR vs. frequency

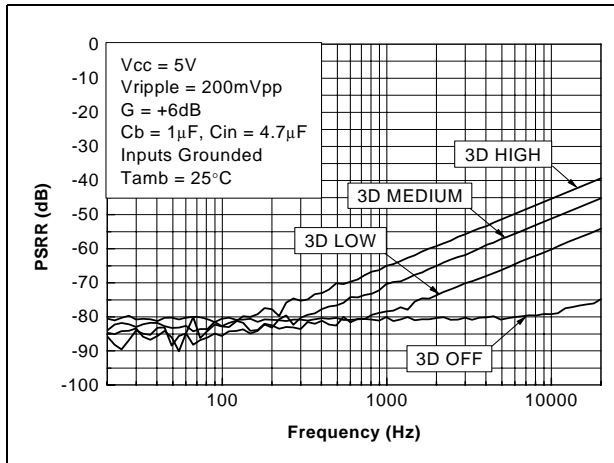

Figure 21. PSRR vs. frequency

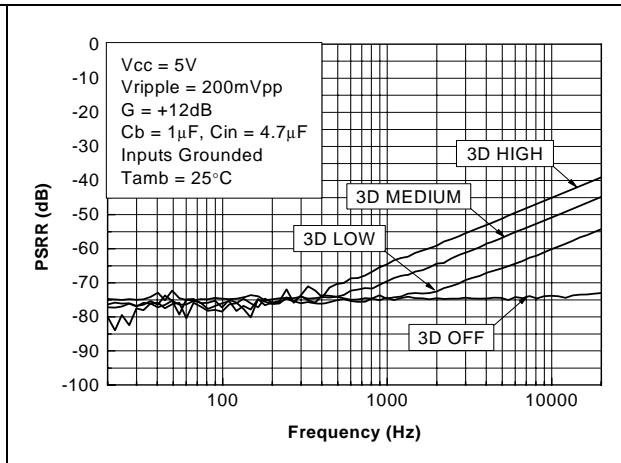

Figure 22. PSRR vs. frequency

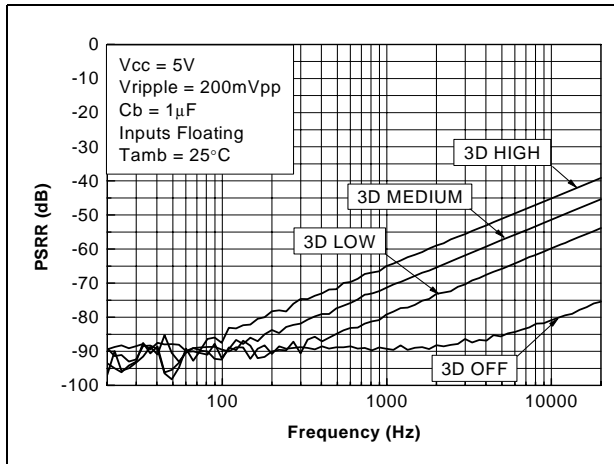

Figure 23. PSRR vs. frequency

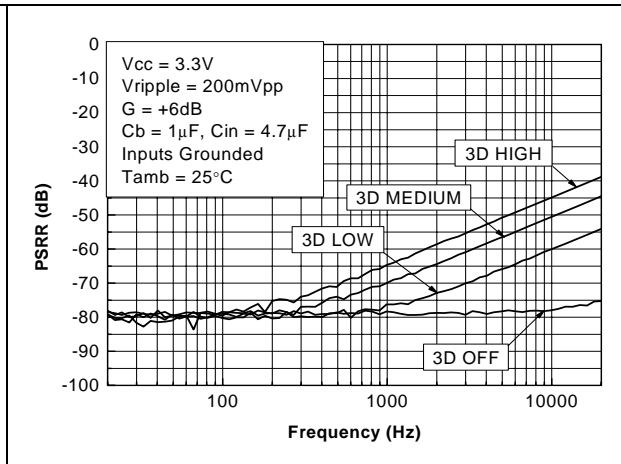

Figure 24. PSRR vs. frequency

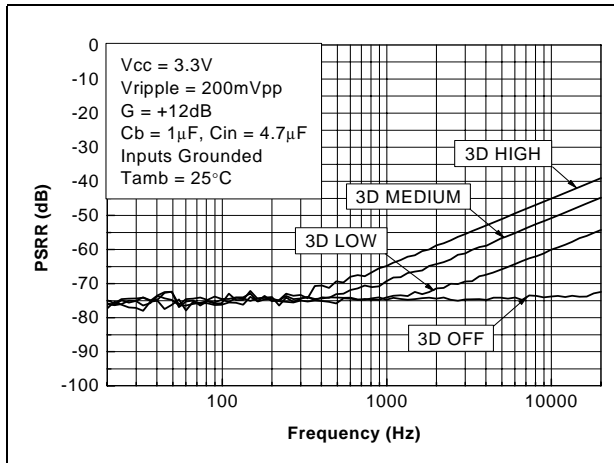

Figure 25. PSRR vs. frequency

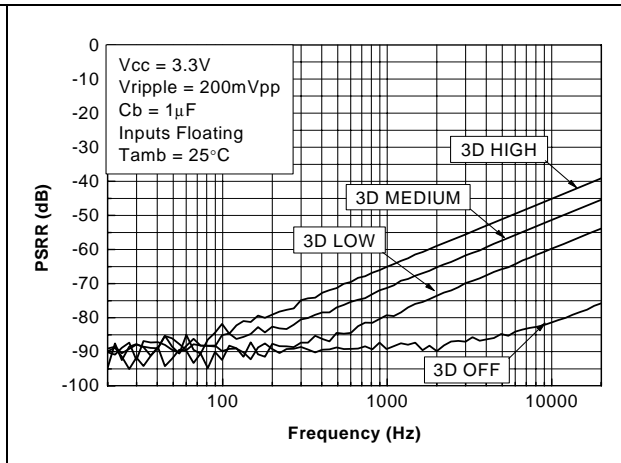

Figure 26. PSRR vs. frequency

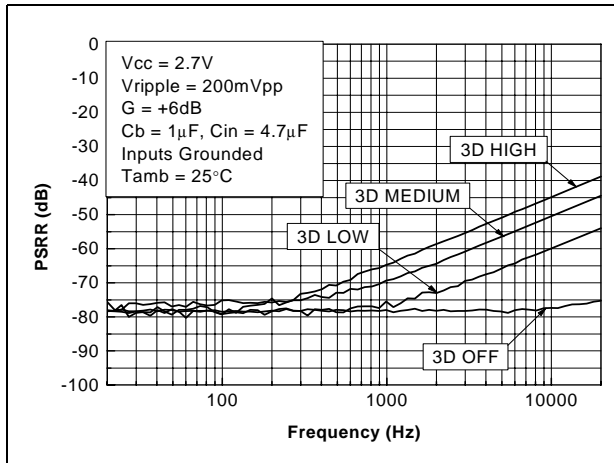

Figure 27. PSRR vs. frequency

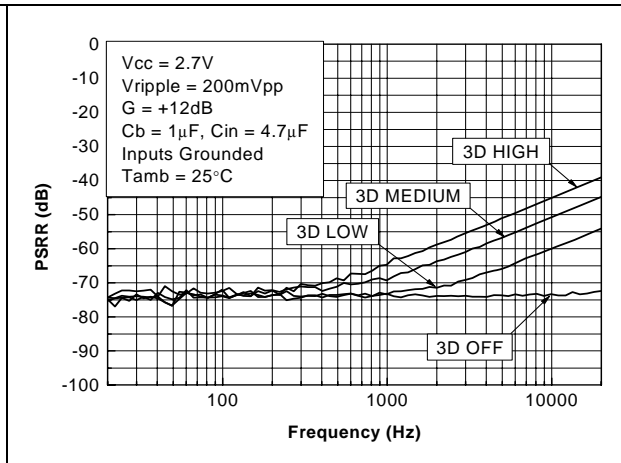

Figure 28. PSRR vs. frequency

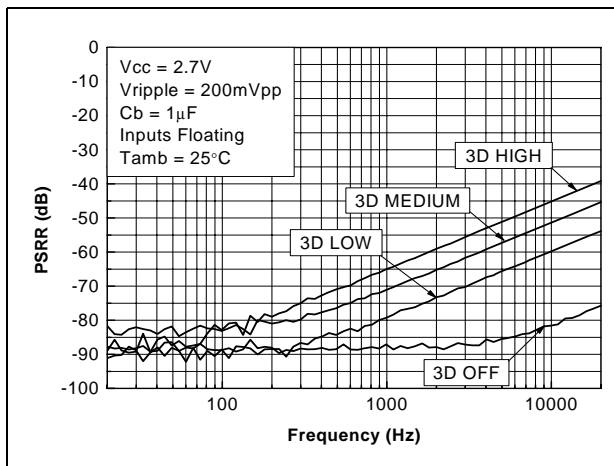

Figure 29. PSRR vs. common mode input voltage

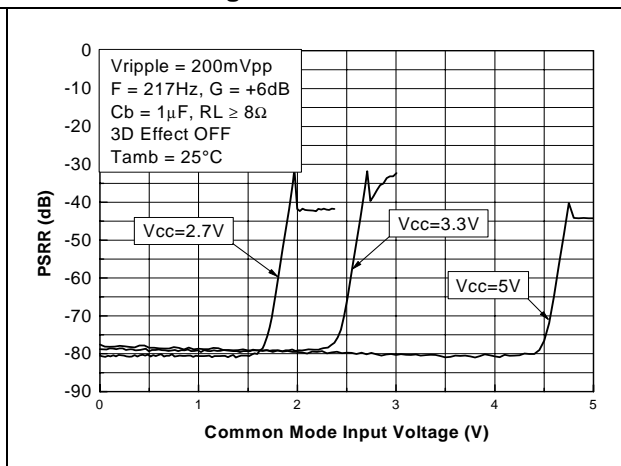

Figure 30. CMRR vs. frequency

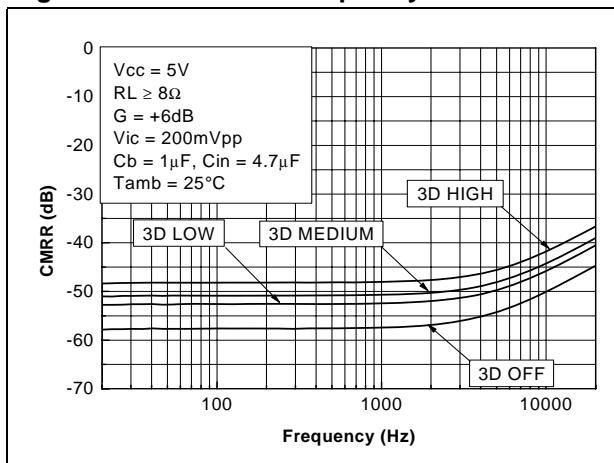

Figure 31. CMRR vs. frequency

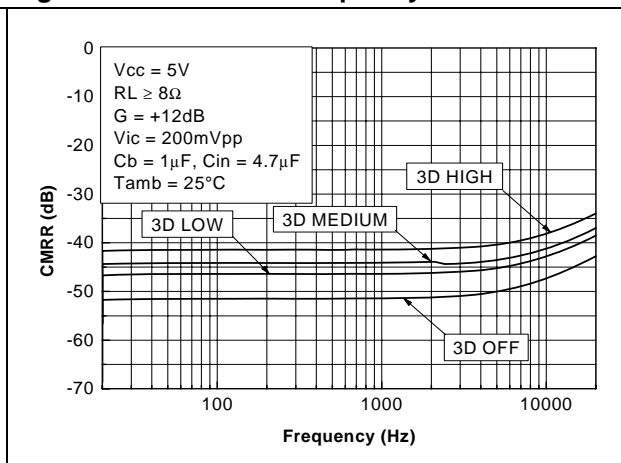

Figure 32. CMRR vs. frequency

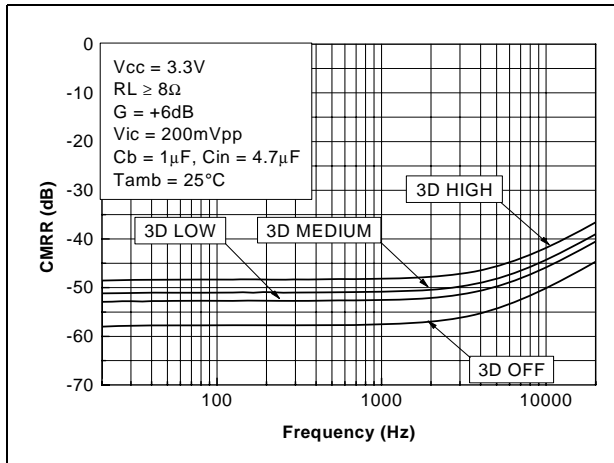

Figure 33. CMRR vs. frequency

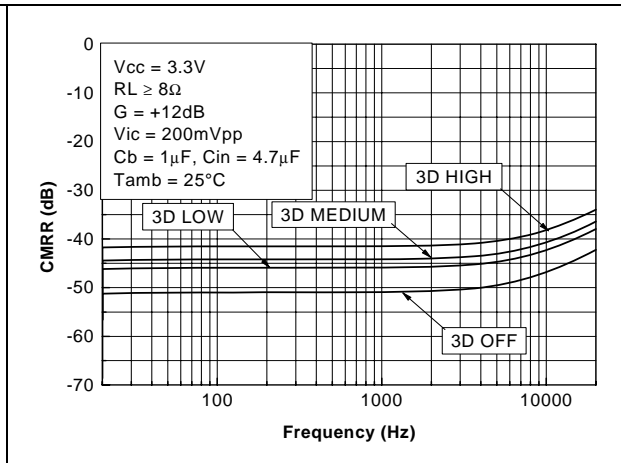

Figure 34. CMRR vs. frequency

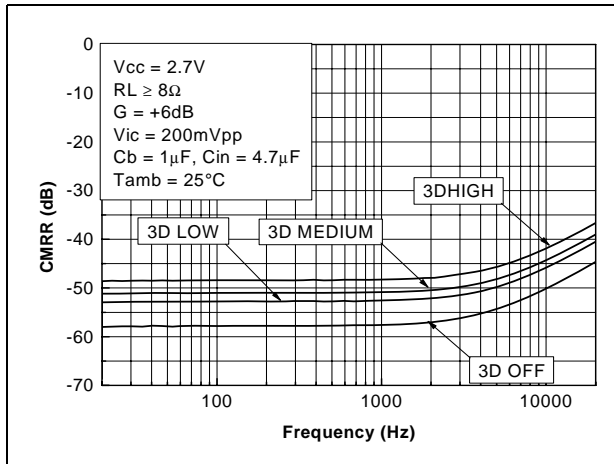

Figure 35. CMRR vs. frequency

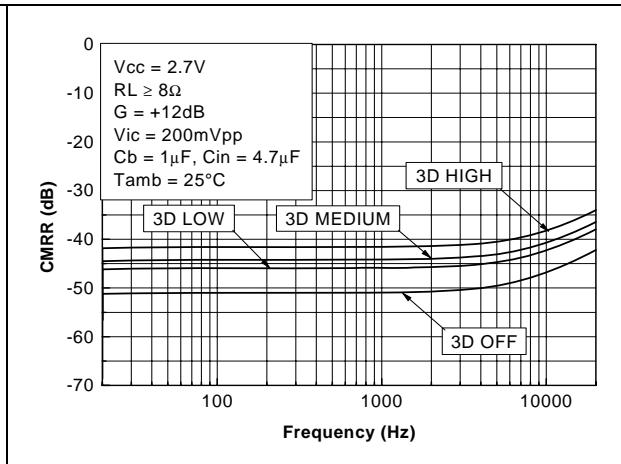

Figure 36. CMRR vs. common mode input voltage

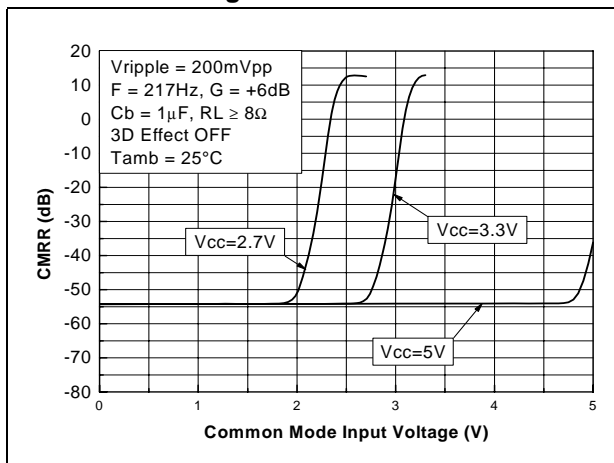

Figure 37. Crosstalk vs. frequency

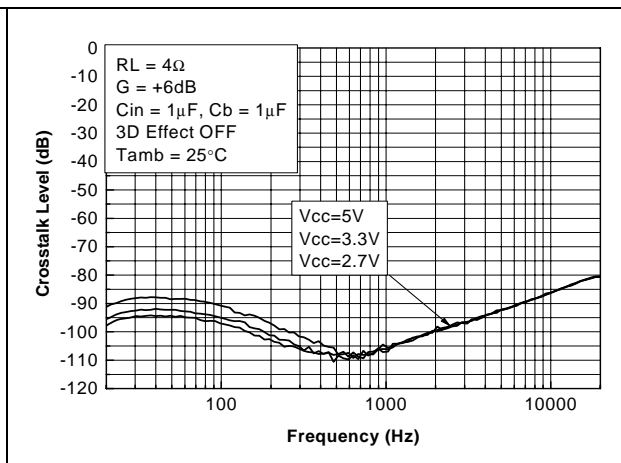

Figure 38. Crosstalk vs. frequency

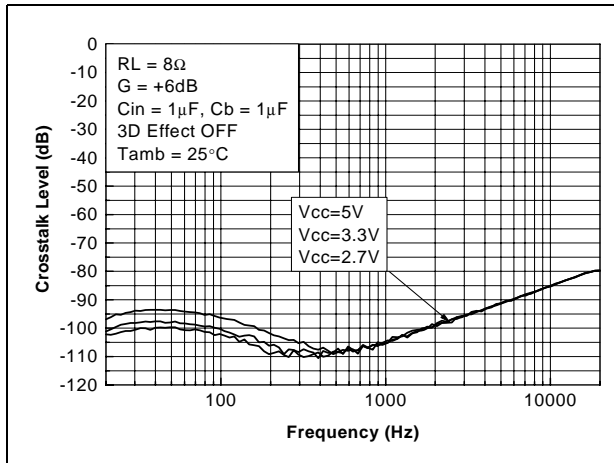

Figure 39. Crosstalk vs. frequency

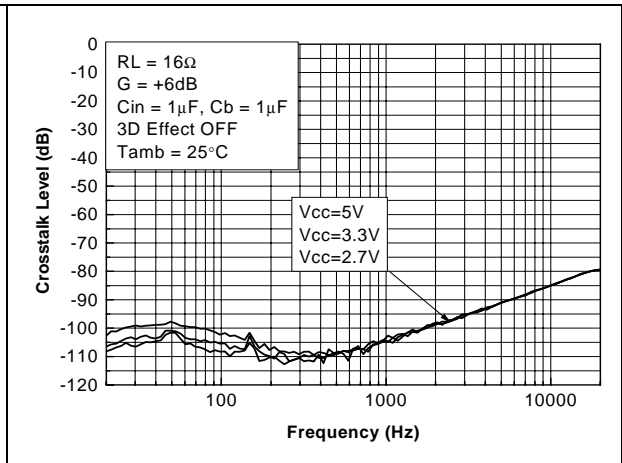

Figure 40. SNR vs. power supply voltage

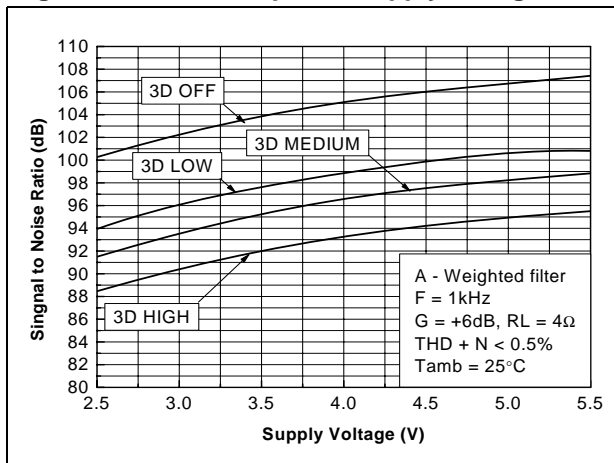

Figure 41. SNR vs. power supply voltage

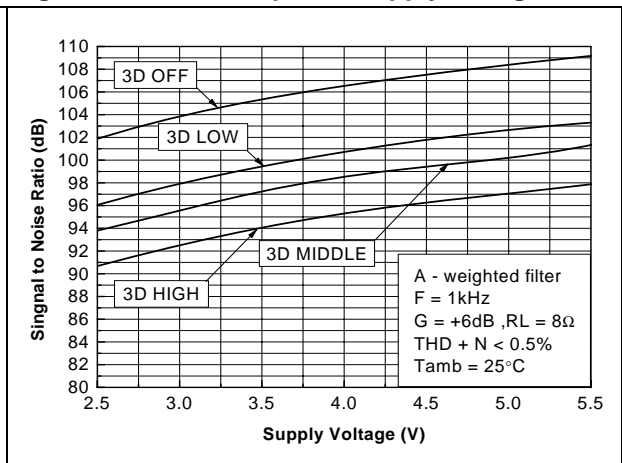

Figure 42. SNR vs. power supply voltage

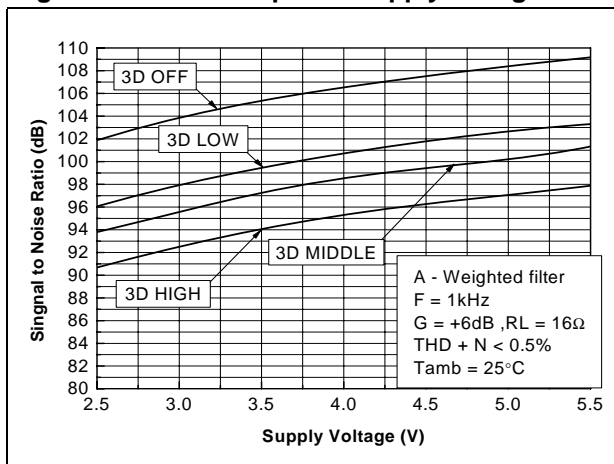

Figure 43. SNR vs. power supply voltage

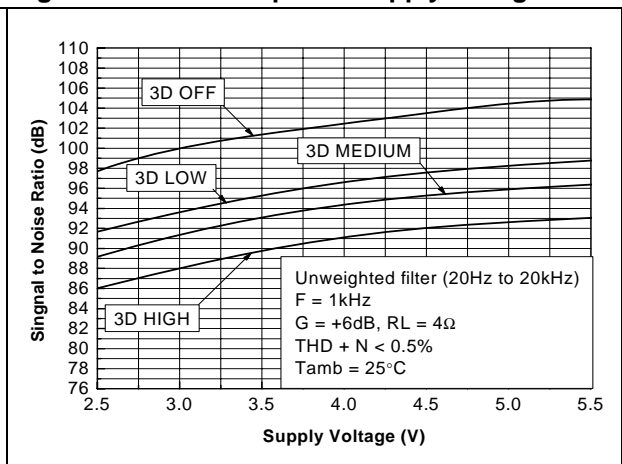

Figure 44. SNR vs. power supply voltage

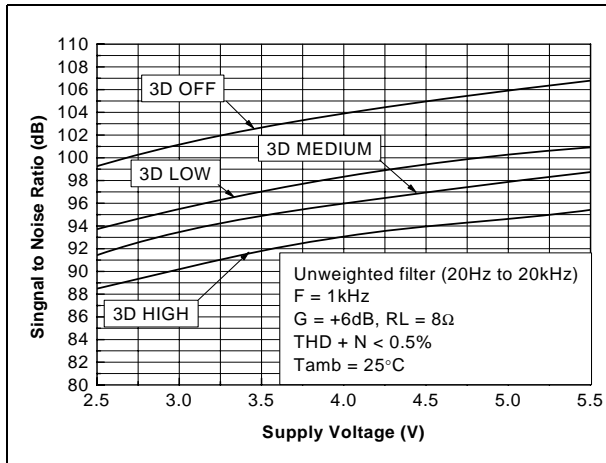

Figure 45. SNR vs. power supply voltage

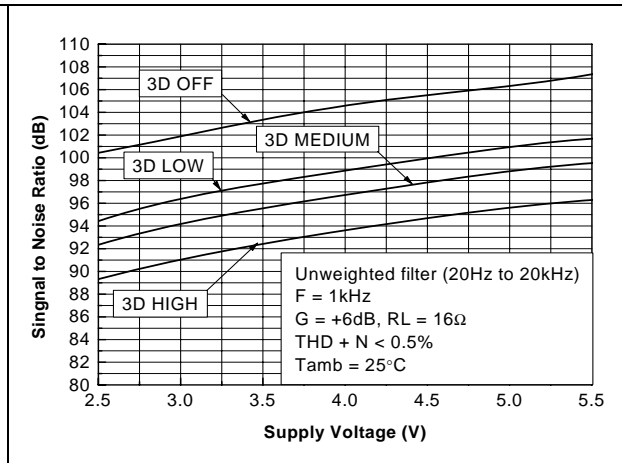

Figure 46. Differential DC output voltage vs. common mode input voltage

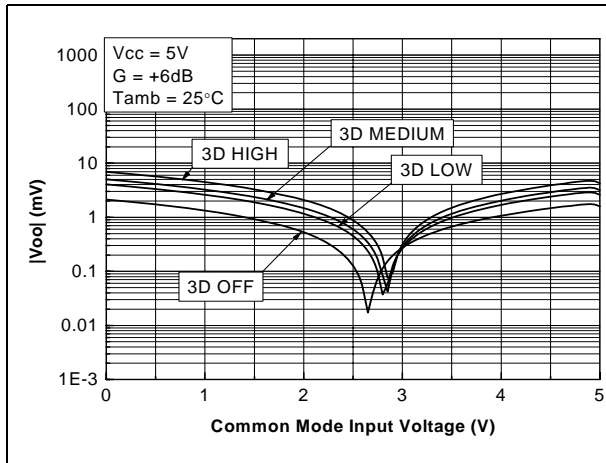

Figure 47. Differential DC output voltage vs. common mode input voltage

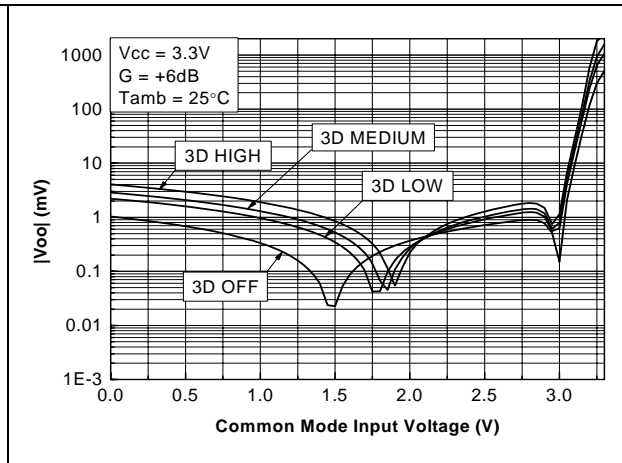

Figure 48. Differential DC output voltage vs. common mode input voltage

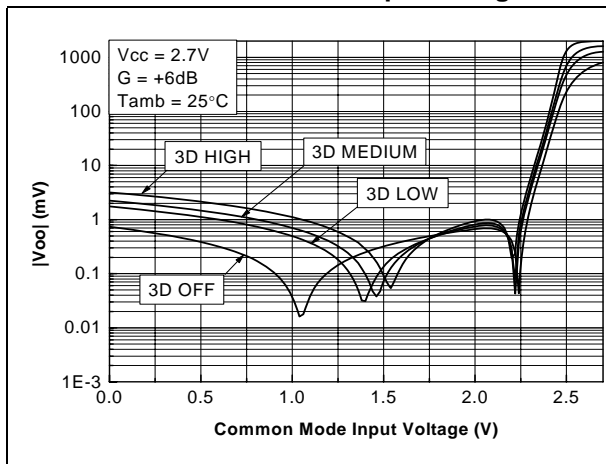

Figure 49. Current consumption vs. power supply voltage

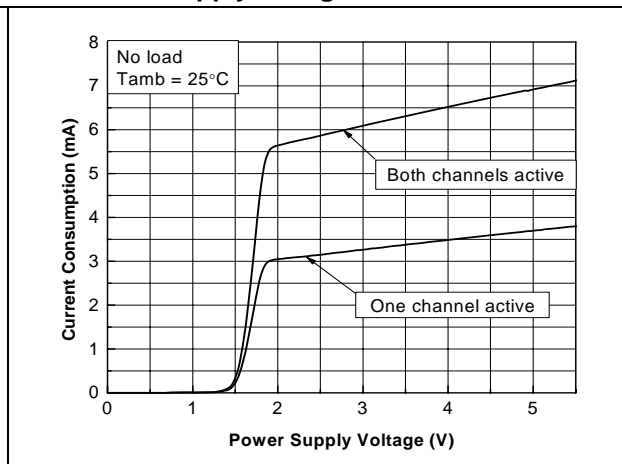



Figure 50. Current consumption vs. standby voltage

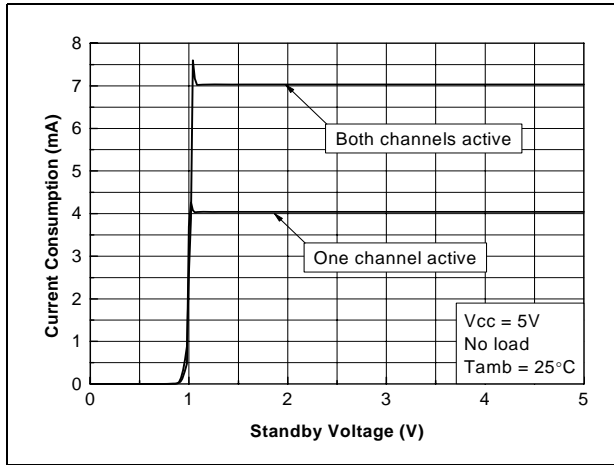

Figure 51. Current consumption vs. standby voltage

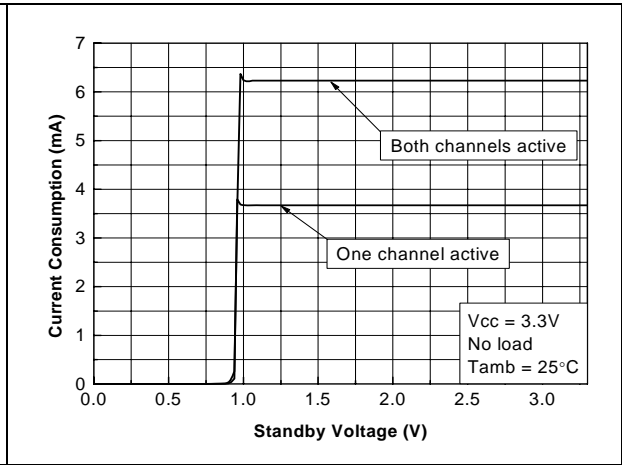

Figure 52. Current consumption vs. standby voltage

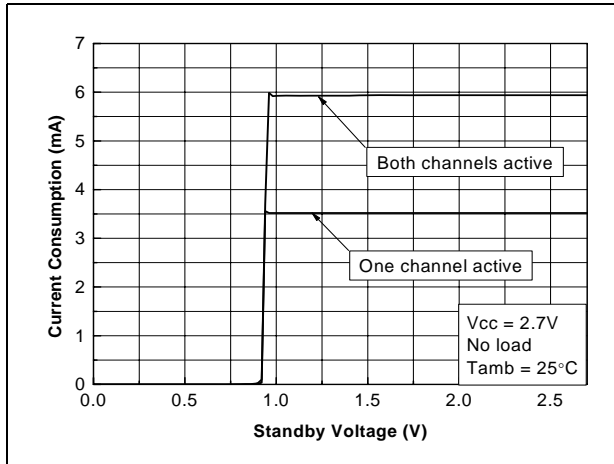

Figure 53. Standby current vs. power supply voltage

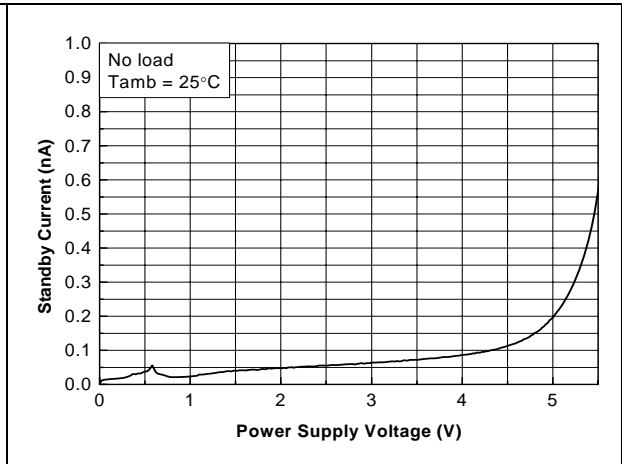

Figure 54. Frequency response

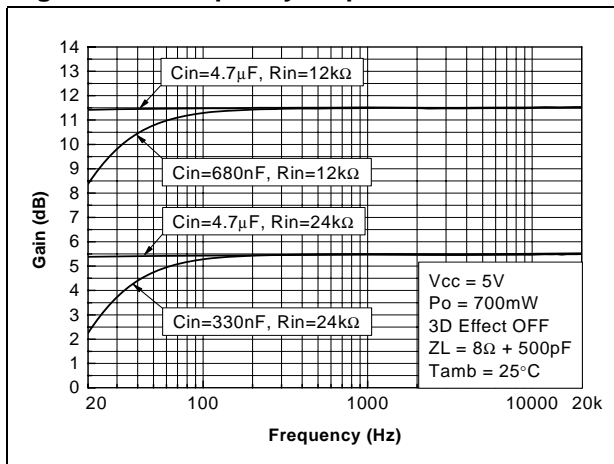

Figure 55. Frequency response

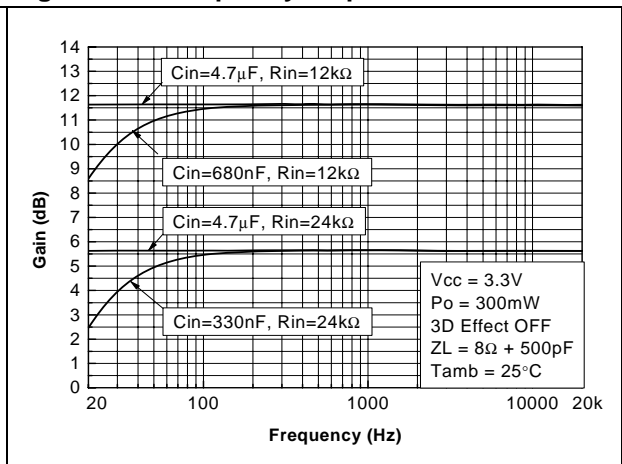

Figure 56. Frequency response

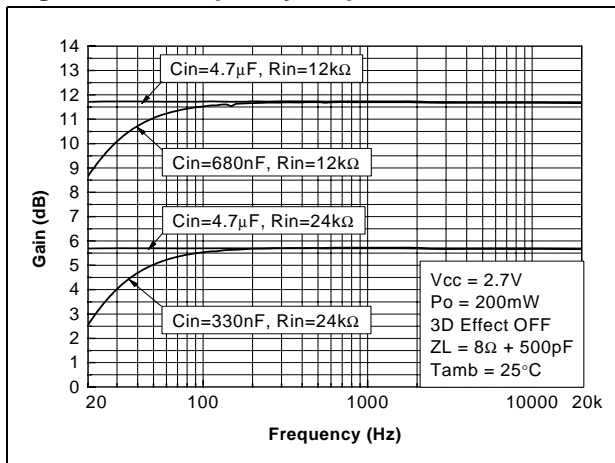

Figure 57. Output power vs. load resistance

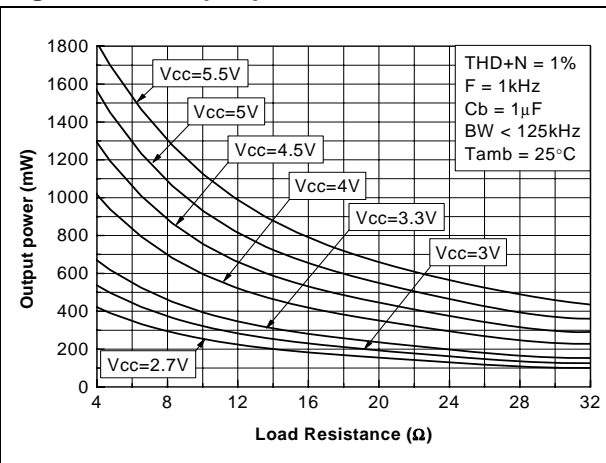

Figure 58. Output power vs. power supply voltage

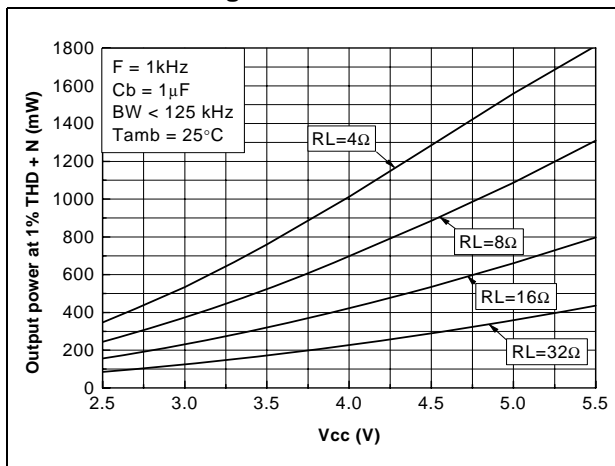

Figure 59. Output power vs. power supply voltage

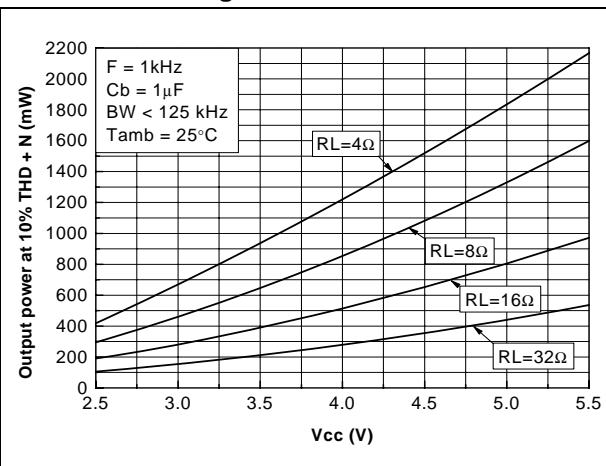

Figure 60. Power dissipation vs. output power

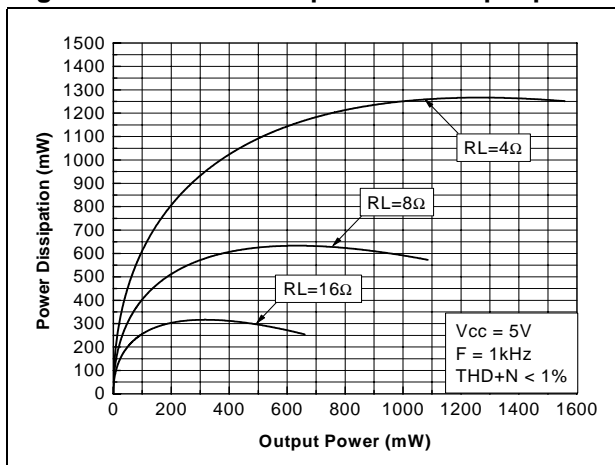

Figure 61. Power dissipation vs. output power

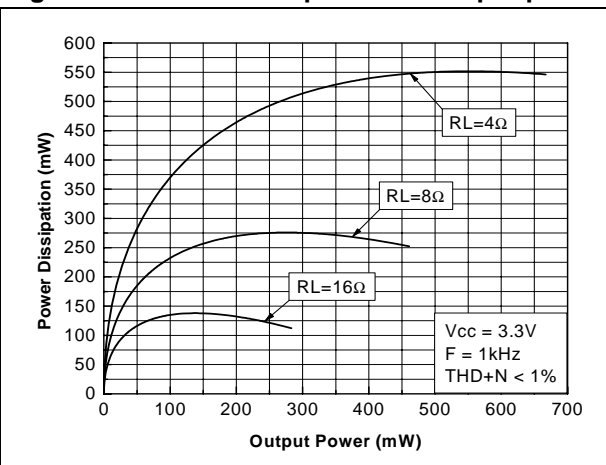

Figure 62. Power dissipation vs. output power Figure 63. Power derating curves

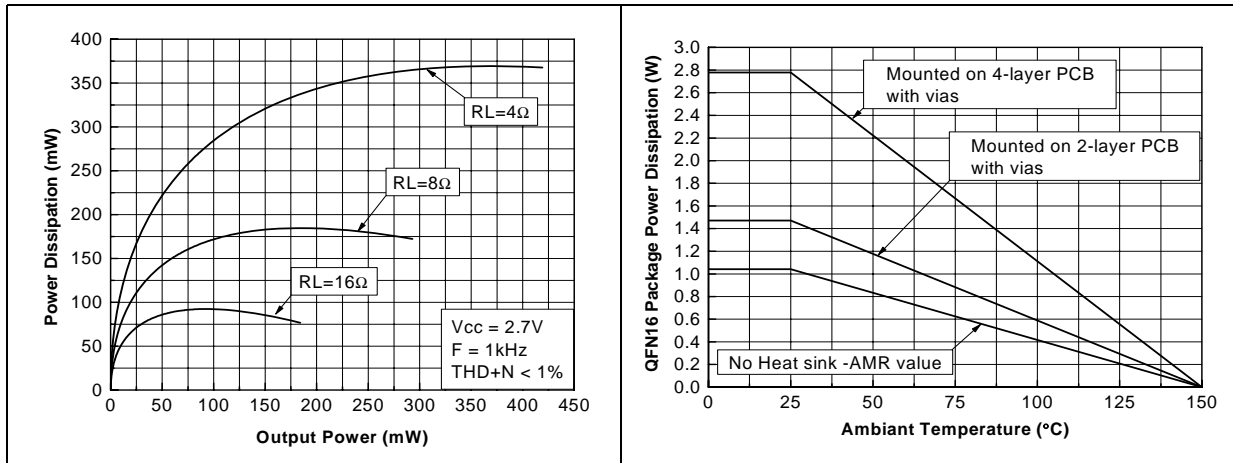

Table 8. Output noise, T<sub>amb</sub> = 25°C

Conditions	3D effect level	Unweighted filter (20Hz to 20kHz) V <sub>CC</sub> = 2.7V to 5.5V	A-weighted filter V <sub>CC</sub> = 2.7V to 5.5V
Inputs floating	OFF	10μVrms	6μVrms
Inputs floating	LOW	18μVrms	12μVrms
Inputs floating	MEDIUM	24μVrms	15μVrms
Inputs floating	HIGH	34μVrms	22μVrms
Inputs grounded, G=6dB	OFF	15μVrms	10μVrms
Inputs grounded, G=6dB	LOW	28μVrms	19μVrms
Inputs grounded, G=6dB	MEDIUM	36μVrms	24μVrms
Inputs grounded, G=6dB	HIGH	52μVrms	35μVrms
Inputs grounded, G=12dB	OFF	20μVrms	14μVrms
Inputs grounded, G=12dB	LOW	39μVrms	26μVrms
Inputs grounded, G=12dB	MEDIUM	50μVrms	33μVrms
Inputs grounded, G=12dB	HIGH	71μVrms	48μVrms

## 4 Application information

### 4.1 General description

The TS4997 integrates two monolithic full-differential input/output power amplifiers with two selectable standby pins dedicated for each channel. The gain of each channel is set by external input resistors.

The TS4997 also features 3D effect enhancements that can be programmed through a two digital input pin interface that allows changing 3D effect levels in three steps.

### 4.2 Differential configuration principle

The TS4997 also includes a common mode feedback loop that controls the output bias value to average it at  $V_{CC}/2$  for any DC common mode input voltage. This allows maximum output voltage swing, and therefore, to maximize the output power. Moreover, as the load is connected differentially instead of single-ended, output power is four times higher for the same power supply voltage.

The **advantages** of a full-differential amplifier are:

- High PSRR (power supply rejection ratio),
- High common mode noise rejection,
- Virtually no pops&clicks without additional circuitry, giving a faster startup time compared to conventional single-ended input amplifiers,
- Easier interfacing with differential output audio DAC,
- No input coupling capacitors required due to common mode feedback loop.

In theory, the filtering of the internal bias by an external bypass capacitor is not necessary. However, to reach maximum performance in all tolerance situations, it is recommended to keep this option.

The only constraint is that the differential function is directly linked to external resistor mismatching, therefore you must pay particular attention to this mismatching in order to obtain the best performance from the amplifier.

### 4.3 Gain in typical application schematic

A typical differential application is shown in [Figure 1 on page 3](#).

The value of the differential gain of each amplifier is dependent on the values of external input resistors  $R_{IN1}$  to  $R_{IN4}$  and of integrated feedback resistors with fixed value. In the flat region of the frequency-response curve (no  $C_{IN}$  effect), the differential gain of each channel is expressed by the relation given in [Equation 1](#).

#### Equation 1

$$A_{V_{diff}} = \frac{V_{O+} - V_{O-}}{Diff_{input+} - Diff_{input-}} = \frac{R_{feed}}{R_{IN}} = \frac{50k\Omega}{R_{IN}}$$

where  $R_{IN} = R_{IN1} = R_{IN2} = R_{IN3} = R_{IN4}$  expressed in  $k\Omega$  and  $R_{feed} = 50k\Omega$  (value of internal feedback resistors).

Due to the tolerance on the internal 50kΩ feedback resistors, the differential gain will be in the range (no tolerance on  $R_{IN}$ ):

$$\frac{40\text{k}\Omega}{R_{IN}} \leq A_{V_{diff}} \leq \frac{60\text{k}\Omega}{R_{IN}}$$

The difference of resistance between input resistors of each channel have direct influence on the PSRR, CMRR and other amplifier parameters. In order to reach maximum performance, we recommend matching the input resistors  $R_{IN1}$ ,  $R_{IN2}$ ,  $R_{IN3}$ , and  $R_{IN4}$  with a maximum tolerance of 1%.

*Note:* For the rest of this section,  $A_{V_{diff}}$  will be called  $A_V$  to simplify the mathematical expressions.

## 4.4 Common mode feedback loop limitations

As explained previously, the common mode feedback loop allows the output DC bias voltage to be averaged at  $V_{CC}/2$  for any DC common mode bias input voltage.

Due to the  $V_{ICM}$  limitation of the input stage (see [Table 3 on page 4](#)), the common mode feedback loop can fulfil its role only within the defined range. This range depends upon the values of  $V_{CC}$ ,  $R_{IN}$  and  $R_{feed}$  ( $A_V$ ). To have a good estimation of the  $V_{ICM}$  value, use the following formula:

### Equation 2

$$V_{ICM} = \frac{V_{CC} \times R_{IN} + 2 \times V_{ic} \times R_{feed}}{2 \times (R_{IN} + R_{feed})} = \frac{V_{CC} \times R_{IN} + 2 \times V_{ic} \times 50\text{k}\Omega}{2 \times (R_{IN} + 50\text{k}\Omega)} \text{ (V)}$$

with  $V_{CC}$  in volts,  $R_{IN}$  in kΩ and

$$V_{ic} = \frac{\text{Diff}_{input+} + \text{Diff}_{input-}}{2} \text{ (V)}$$

The result of the calculation must be in the range:

$$\text{GND} \leq V_{ICM} \leq V_{CC} - 1\text{V}$$

Due to the +/-20% tolerance on the 50kΩ feedback resistors  $R_{feed}$  (no tolerance on  $R_{IN}$ ), it is also important to check that the  $V_{ICM}$  remains in this range at the tolerance limits:

$$\frac{V_{CC} \times R_{IN} + 2 \times V_{ic} \times 40\text{k}\Omega}{2 \times (R_{IN} + 40\text{k}\Omega)} \leq V_{ICM} \leq \frac{V_{CC} \times R_{IN} + 2 \times V_{ic} \times 60\text{k}\Omega}{2 \times (R_{IN} + 60\text{k}\Omega)} \text{ (V)}$$

If the result of the  $V_{ICM}$  calculation is not in this range, an input coupling capacitor must be used.

**Example:**  $V_{CC} = 2.7\text{V}$ ,  $A_V = 2$ , and  $V_{ic} = 2.2\text{V}$ .

With internal resistors  $R_{feed} = 50\text{k}\Omega$ , calculated external resistors are  $R_{IN} = R_{feed}/A_V = 25\text{k}\Omega$ ,  $V_{CC} = 2.7\text{V}$  and  $V_{ic} = 2.2\text{V}$ , which gives  $V_{ICM} = 1.92\text{V}$ . Taking into account the tolerance on the feedback resistors, with  $R_{feed} = 40\text{k}\Omega$  the common mode input voltage is  $V_{ICM} = 1.87\text{V}$  and with  $R_{feed} = 60\text{k}\Omega$ , it is  $V_{ICM} = 1.95\text{V}$ .

These values are not in range from GND to  $V_{CC} - 1\text{V} = 1.7\text{V}$ , therefore input coupling capacitors are required. Alternatively, you can change the  $V_{ic}$  value.

### 4.5 Low frequency response

The input coupling capacitors block the DC part of the input signal at the amplifier inputs. In the low frequency region,  $C_{IN}$  starts to have an effect.  $C_{IN}$  and  $R_{IN}$  form a first-order high pass filter with a -3dB cut-off frequency.

$$F_{CL} = \frac{1}{2 \times \pi \times R_{IN} \times C_{IN}} \text{ (Hz)}$$

with  $R_{IN}$  expressed in  $\Omega$  and  $C_{IN}$  expressed in F.

So, for a desired -3dB cut-off frequency we can calculate  $C_{IN}$ :

$$C_{IN} = \frac{1}{2 \times \pi \times R_{IN} \times F_{CL}} \text{ (F)}$$

From [Figure 64](#), you can easily establish the  $C_{IN}$  value required for a -3 dB cut-off frequency for some typical cases.

**Figure 64. -3dB lower cut-off frequency vs. input capacitance**

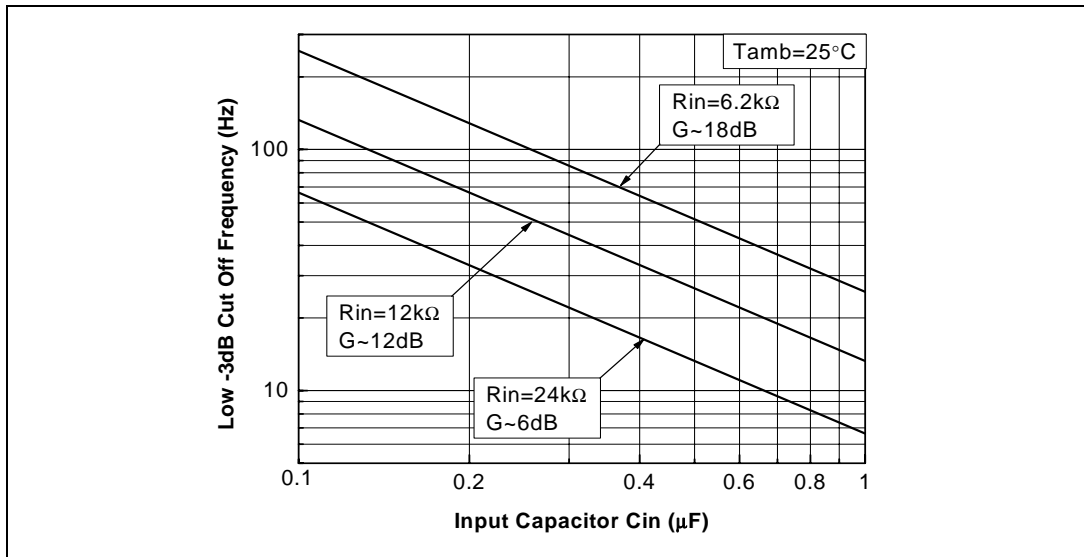

### 4.6 3D effect enhancement

The TS4997 features 3D audio effect which can be programmed at three discrete levels (LOW, MEDIUM, HIGH) through input pins 3D1 and 3D0 which provide a digital interface. The correspondence between the logic levels of this interface and 3D effect levels are shown in [Table 9](#).

The 3D audio effect applied to stereo audio signals evokes perception of spatial hearing and improves this effect in cases where the stereo speakers are too close to each other, such as in small handheld devices, or mobile equipment.

The perceived amount of 3D effect is also dependent on many factors such as speaker position, distance between speakers and listener, frequency spectrum of audio signal, or difference of signal between left and right channel. In some cases, the volume can increase when switching on the 3D effect. This factor is dependent on the composition of the stereo audio signal and its frequency spectrum.

Table 9. 3D effect settings

3D effect level	3D0	3D1
OFF	0	0
LOW	0	1
MEDIUM	1	0
HIGH	1	1

## 4.7 Power dissipation and efficiency

### Assumptions:

- Load voltage and current are sinusoidal ( $V_{out}$  and  $I_{out}$ )
- Supply voltage is a pure DC source ( $V_{CC}$ )

The output voltage is:

$$V_{out} = V_{peak} \sin \alpha \text{ (V)}$$

and

$$I_{out} = \frac{V_{out}}{R_L} \text{ (A)}$$

and

$$P_{out} = \frac{V_{peak}^2}{2R_L} \text{ (W)}$$

Therefore, the average current delivered by the supply voltage is:

### Equation 3

$$I_{ccAVG} = 2 \frac{V_{peak}}{\pi R_L} \text{ (A)}$$

The power delivered by the supply voltage is:

### Equation 4

$$P_{supply} = V_{CC} I_{ccAVG} \text{ (W)}$$

Therefore, the **power dissipated by each amplifier** is:

$$P_{diss} = P_{supply} - P_{out} \text{ (W)}$$

$$P_{diss} = \frac{2\sqrt{2}V_{CC}}{\pi\sqrt{R_L}} \sqrt{P_{out}} - P_{out} \text{ (W)}$$

and the maximum value is obtained when:

$$\frac{\partial P_{diss}}{\partial P_{out}} = 0$$

and its value is:

### Equation 5

$$P_{dissmax} = \frac{2V_{CC}^2}{\pi^2 R_L} \text{ (W)}$$

*Note:* This maximum value is only dependent on the power supply voltage and load values.

The **efficiency** is the ratio between the output power and the power supply:

### Equation 6

$$\eta = \frac{P_{out}}{P_{supply}} = \frac{\pi V_{peak}}{4V_{CC}}$$

The maximum theoretical value is reached when  $V_{peak} = V_{CC}$ , so:

$$\eta = \frac{\pi}{4} = 78.5\%$$

The TS4997 is stereo amplifier so it has two power amplifiers. Each amplifier produces heat due to its power dissipation. Therefore, the maximum die temperature is the sum of each amplifier's maximum power dissipation. It is calculated as follows:

- $P_{diss1}$  = Power dissipation of left channel power amplifier
- $P_{diss2}$  = Power dissipation of right channel power amplifier
- Total  $P_{diss} = P_{diss1} + P_{diss2}$  (W)

In most cases,  $P_{diss1} = P_{diss2}$ , giving:

$$\text{Total } P_{diss} = 2 \times P_{diss1} = \frac{4\sqrt{2}V_{CC}}{\pi\sqrt{R_L}} \sqrt{P_{out}} - 2P_{out} \text{ (W)}$$

The maximum die temperature allowable for the TS4997 is 150°C. In case of overheating, a thermal shutdown protection set to 150°C, puts the TS4997 in standby until the temperature of the die is reduced by about 5°C.

To calculate the maximum ambient temperature  $T_{amb}$  allowable, you need to know:

- the power supply voltage value,  $V_{CC}$
- the load resistor value,  $R_L$
- the package type,  $R_{THJA}$

**Example:**  $V_{CC}=5V$ ,  $R_L=8\Omega$ ,  $R_{THJAQFN16}=85^\circ\text{C/W}$  (with 2-layer PCB with vias).

Using the power dissipation formula given in [Equation 5](#), the maximum dissipated power per channel is:

$$P_{dissmax} = 633\text{mW}$$

And the power dissipated by both channels is:

$$\text{Total } P_{dissmax} = 2 \times P_{dissmax} = 1266\text{mW}$$



$T_{amb}$  is calculated as follows:

**Equation 7**

$$T_{amb} = 150^{\circ}\text{C} - R_{THJA} \times \text{Total}P_{dissmax}$$

Therefore, the maximum allowable value for  $T_{amb}$  is:

$$T_{amb} = 150 - 85 \times 2 \times 1.266 = 42.4^{\circ}\text{C}$$

If a 4-layer PCB with vias is used,  $R_{THJA} \text{ QFN16} = 45^{\circ}\text{C/W}$  and the maximum allowable value for  $T_{amb}$  in this case is:

$$T_{amb} = 150 - 45 \times 2 \times 1.266 = 93^{\circ}\text{C}$$

### 4.8 Footprint recommendation

Footprint soldering pad dimensions are given in [Figure 72 on page 31](#). As discussed in the previous section, the maximum allowable value for ambient temperature is dependent on the thermal resistance junction to ambient  $R_{THJA}$ . Decreasing the  $R_{THJA}$  value causes better power dissipation.

Based on best thermal performance, it is recommended to use 4-layer PCBs with vias to effectively remove heat from the device. It is also recommended to use vias for 2-layer PCBs to connect the package exposed pad to heatsink cooper areas placed on another layer.

For proper thermal conductivity, the vias must be plated through and solder-filled. Typical thermal vias have the following dimensions: 1.2mm pitch, 0.3mm diameter.

**Figure 65. QFN16 footprint recommendation**

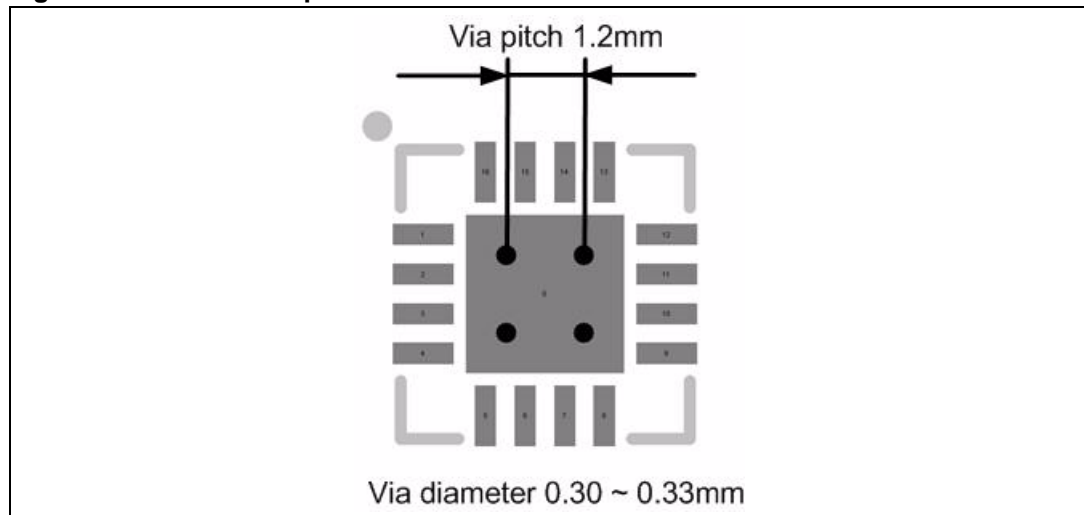

### 4.9 Decoupling of the circuit

Two capacitors are needed to correctly bypass the TS4997: a power supply bypass capacitor  $C_S$  and a bias voltage bypass capacitor  $C_b$ .

The  $C_S$  capacitor has particular influence on the THD+N at high frequencies (above 7kHz) and an indirect influence on power supply disturbances. With a value for  $C_S$  of 1 $\mu$ F, one can expect THD+N performance similar to that shown in the datasheet.

In the high frequency region, if  $C_S$  is lower than 1 $\mu$ F, then THD+N increases and disturbances on the power supply rail are less filtered.

On the other hand, if  $C_S$  is greater than 1 $\mu$ F, then those disturbances on the power supply rail are more filtered.

The  $C_b$  capacitor has an influence on the THD+N at lower frequencies, but also impacts PSRR performance (with grounded input and in the lower frequency region).

### 4.10 Standby control and wake-up time $t_{WU}$

The TS4997 has two dedicated standby pins (STBYL, STBYR). These pins allow to put each channel in standby mode or active mode independently. The amplifier is designed to reach close to zero pop when switching from one mode to the other.

When both channels are in standby ( $V_{STBYL} = V_{STBYR} = GND$ ), the circuit is in shutdown mode. When at least one of the two standby pins is released to put the device ON, the bypass capacitor  $C_b$  starts to be charged. Because  $C_b$  is directly linked to the bias of the amplifier, the bias will not work properly until the  $C_b$  voltage is correct. The time to reach this voltage is called the wake-up time or  $t_{WU}$  and is specified in [Table 4 on page 5](#), with  $C_b=1\mu$ F.

During the wake-up phase, the TS4997 gain is close to zero. After the wake-up time, the gain is released and set to its nominal value. If  $C_b$  has a value different from 1 $\mu$ F, then refer to the graph in [Figure 66](#) to establish the corresponding wake-up time.

When a channel is set to standby mode, the outputs of this channel are in high impedance state.

**Figure 66. Typical startup time vs. bypass capacitor**

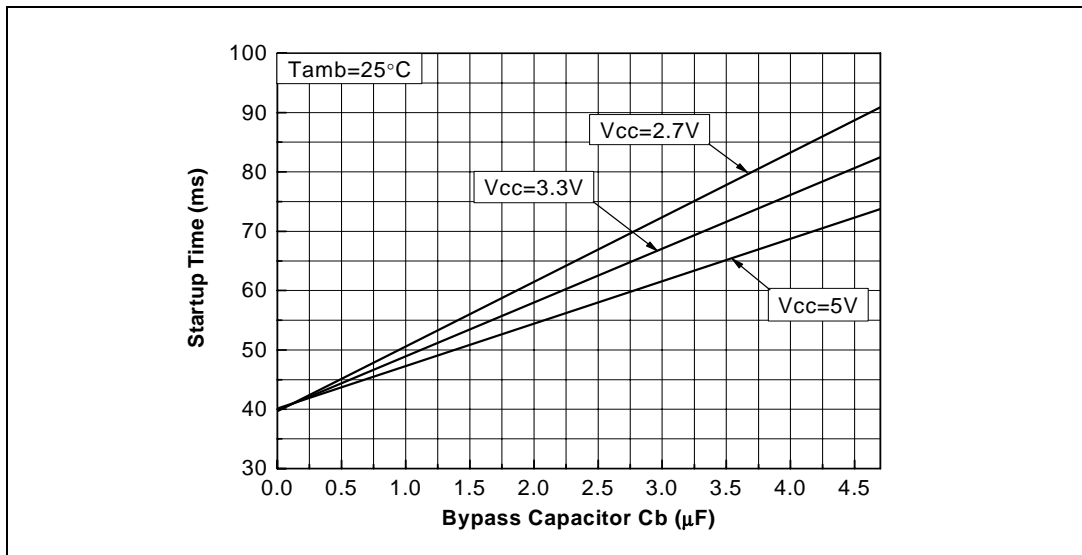

## 4.11 Shutdown time

When the standby command is activated (both channels put into standby mode), the time required to put the two output stages of each channel in high impedance and the internal circuitry in shutdown mode is a few microseconds.

*Note:* In shutdown mode when both channels are in standby, the Bypass pin and  $L_{IN+}$ ,  $L_{IN-}$ ,  $R_{IN+}$ ,  $R_{IN-}$  pins are shorted to ground by internal switches. This allows a quick discharge of  $C_b$  and  $C_{IN}$  capacitors.

## 4.12 Pop performance

Due to its fully differential structure, the pop performance of the TS4997 is close to perfect. However, due to mismatching between internal resistors  $R_{feed}$ , external resistors  $R_{IN}$  and external input capacitors  $C_{IN}$ , some noise might remain at startup. To eliminate the effect of mismatched components, the TS4997 includes pop reduction circuitry. With this circuitry, the TS4997 is close to zero pop for all possible common applications.

In addition, when the TS4997 is in standby mode, due to the high impedance output stage in this configuration, no pop is heard.

## 4.13 Single-ended input configuration

It is possible to use the TS4997 in a single-ended input configuration. However, input coupling capacitors are needed in this configuration. The schematic diagram in [Figure 67](#) shows an example of this configuration for a gain of +6dB set by the input resistors.

Figure 67. Typical single-ended input application

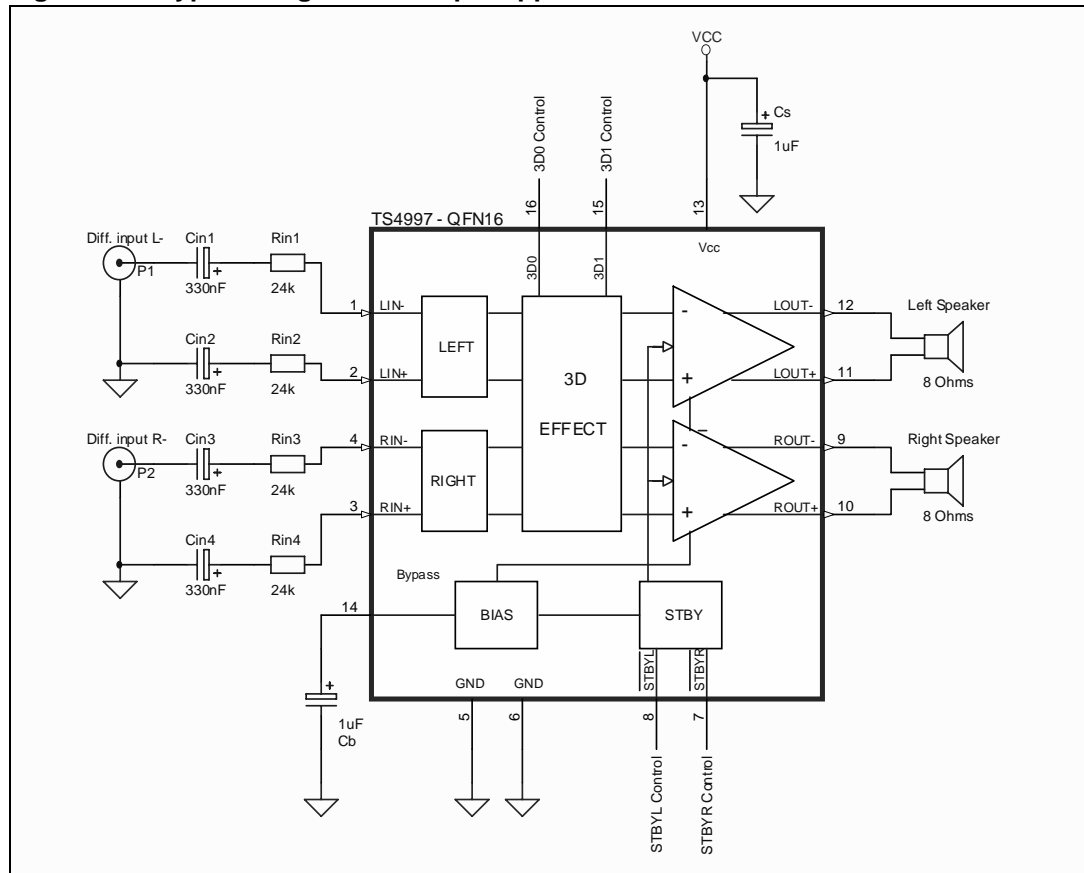

The component calculations remain the same for the gain. In single-ended input configuration, the formula is:

$$A_{VSE} = \frac{V_{O+} - V_{O-}}{V_e} = \frac{R_{feed}}{R_{IN}} = \frac{50k\Omega}{R_{IN}}$$

with  $R_{IN}$  expressed in  $k\Omega$

#### 4.14 Notes on PSRR measurement

##### What is the PSRR?

The PSRR is the power supply rejection ratio. The PSRR of a device is the ratio between a power supply disturbance and the result on the output. In other words, the PSRR is the ability of a device to minimize the impact of power supply disturbance to the output.

##### How is the PSRR measured?

The PSRR is measured as shown in [Figure 68](#).

Figure 68. PSRR measurement

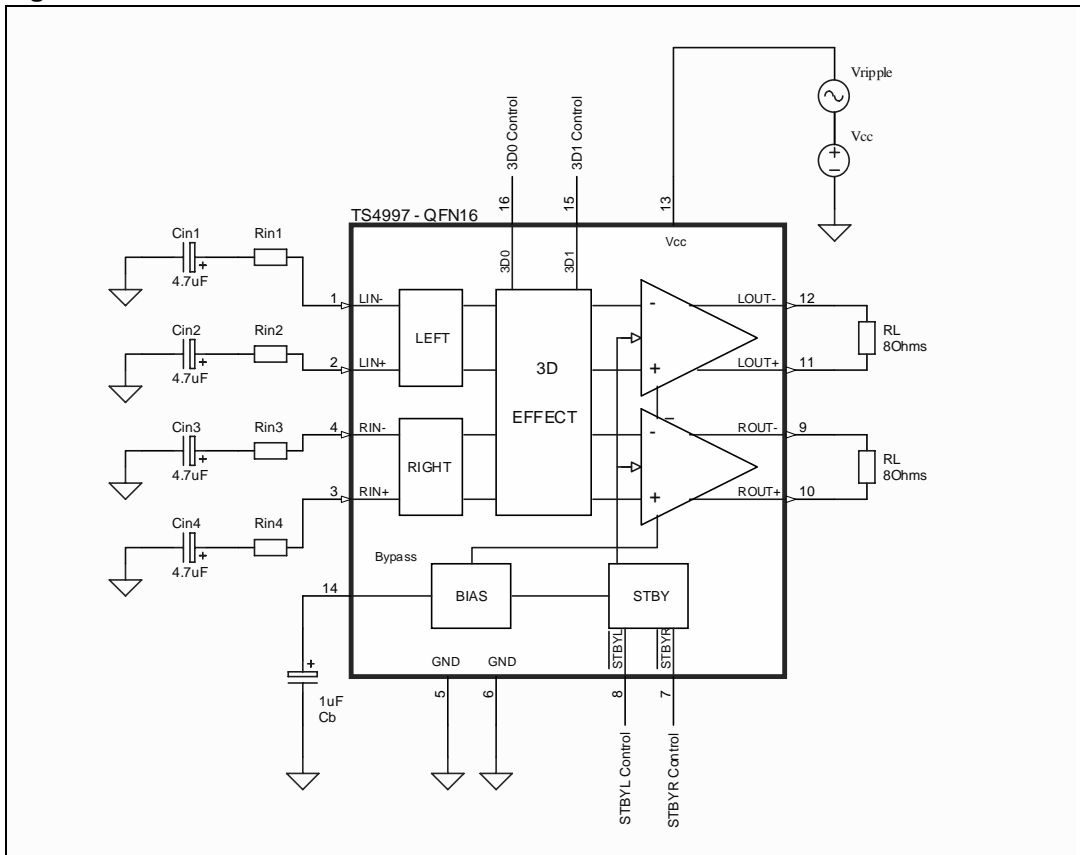

**Principles of operation**

- The DC voltage supply ( $V_{CC}$ ) is fixed
- The AC sinusoidal ripple voltage ( $V_{ripple}$ ) is fixed
- No bypass capacitor  $C_S$  is used

The PSRR value for each frequency is calculated as:

$$PSRR = 20 \times \text{Log} \left[ \frac{RMS_{(Output)}}{RMS_{(V_{ripple})}} \right] \text{ (dB)}$$

RMS is an rms selective measurement.

## 5 QFN16 package information

In order to meet environmental requirements, STMicroelectronics offers these devices in ECOPACK® packages. These packages have a Lead-free second level interconnect. The category of second level interconnect is marked on the package and on the inner box label, in compliance with JEDEC Standard JESD97. The maximum ratings related to soldering conditions are also marked on the inner box label. ECOPACK is an STMicroelectronics trademark. ECOPACK specifications are available at: [www.st.com](http://www.st.com).

Figure 69. QFN16 package

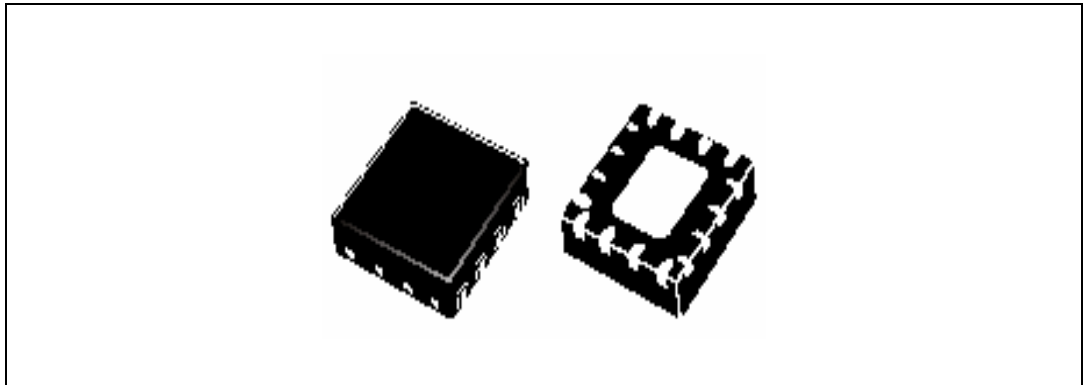

Figure 70. Pinout (top view)

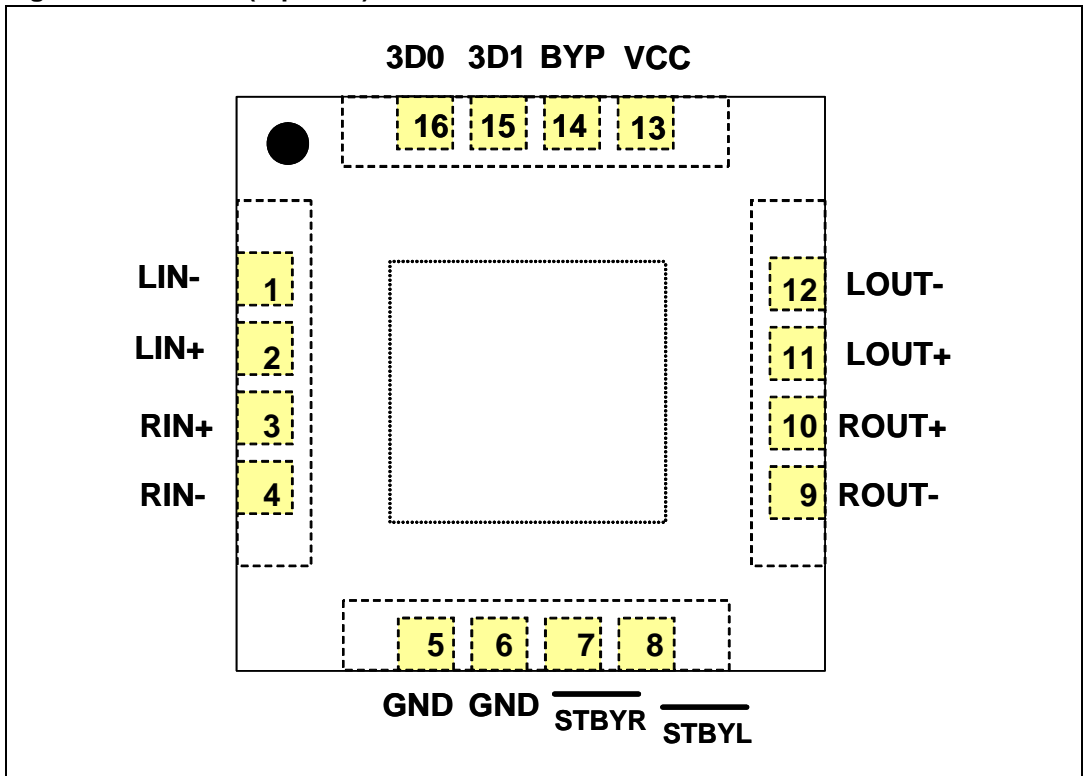

Figure 71. QFN16 4x4mm

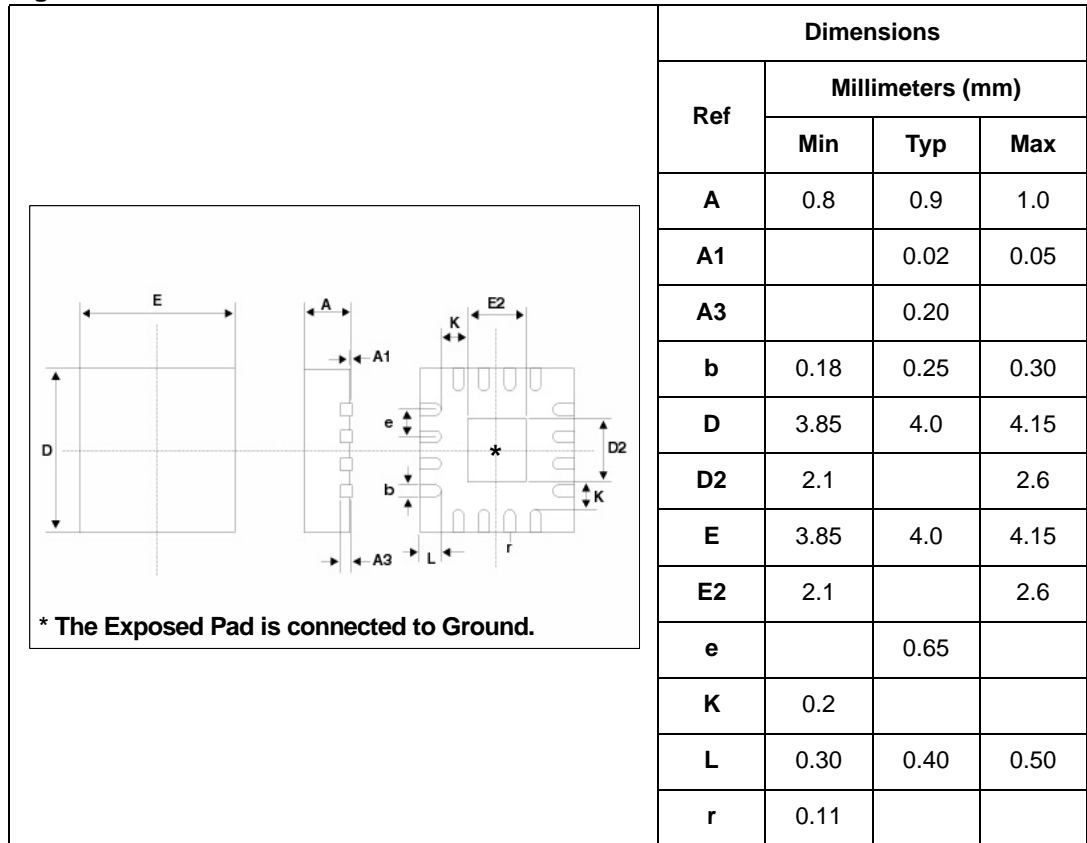
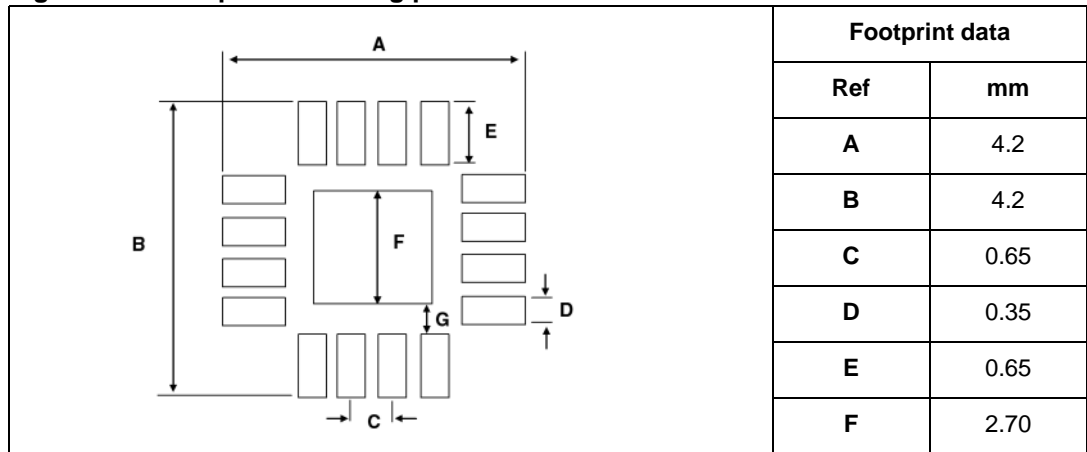

Figure 72. Footprint soldering pad



## 6 Ordering information

Table 10. Order codes

Part number	Temperature range	Package	Packaging	Marking
TS4997IQT	-40°C, +85°C	QFN16 4x4mm	Tape & reel	Q997



## 7 Revision history

Date	Revision	Changes
10-Jan-2007	1	Preliminary data.
20-Feb-2007	2	First release.

**Please Read Carefully:**

Information in this document is provided solely in connection with ST products. STMicroelectronics NV and its subsidiaries ("ST") reserve the right to make changes, corrections, modifications or improvements, to this document, and the products and services described herein at any time, without notice.

All ST products are sold pursuant to ST's terms and conditions of sale.

Purchasers are solely responsible for the choice, selection and use of the ST products and services described herein, and ST assumes no liability whatsoever relating to the choice, selection or use of the ST products and services described herein.

No license, express or implied, by estoppel or otherwise, to any intellectual property rights is granted under this document. If any part of this document refers to any third party products or services it shall not be deemed a license grant by ST for the use of such third party products or services, or any intellectual property contained therein or considered as a warranty covering the use in any manner whatsoever of such third party products or services or any intellectual property contained therein.

**UNLESS OTHERWISE SET FORTH IN ST'S TERMS AND CONDITIONS OF SALE ST DISCLAIMS ANY EXPRESS OR IMPLIED WARRANTY WITH RESPECT TO THE USE AND/OR SALE OF ST PRODUCTS INCLUDING WITHOUT LIMITATION IMPLIED WARRANTIES OF MERCHANTABILITY, FITNESS FOR A PARTICULAR PURPOSE (AND THEIR EQUIVALENTS UNDER THE LAWS OF ANY JURISDICTION), OR INFRINGEMENT OF ANY PATENT, COPYRIGHT OR OTHER INTELLECTUAL PROPERTY RIGHT.**

**UNLESS EXPRESSLY APPROVED IN WRITING BY AN AUTHORIZED ST REPRESENTATIVE, ST PRODUCTS ARE NOT RECOMMENDED, AUTHORIZED OR WARRANTED FOR USE IN MILITARY, AIR CRAFT, SPACE, LIFE SAVING, OR LIFE SUSTAINING APPLICATIONS, NOR IN PRODUCTS OR SYSTEMS WHERE FAILURE OR MALFUNCTION MAY RESULT IN PERSONAL INJURY, DEATH, OR SEVERE PROPERTY OR ENVIRONMENTAL DAMAGE. ST PRODUCTS WHICH ARE NOT SPECIFIED AS "AUTOMOTIVE GRADE" MAY ONLY BE USED IN AUTOMOTIVE APPLICATIONS AT USER'S OWN RISK.**

Resale of ST products with provisions different from the statements and/or technical features set forth in this document shall immediately void any warranty granted by ST for the ST product or service described herein and shall not create or extend in any manner whatsoever, any liability of ST.

ST and the ST logo are trademarks or registered trademarks of ST in various countries.

Information in this document supersedes and replaces all information previously supplied.

The ST logo is a registered trademark of STMicroelectronics. All other names are the property of their respective owners.

© 2007 STMicroelectronics - All rights reserved

STMicroelectronics group of companies

Australia - Belgium - Brazil - Canada - China - Czech Republic - Finland - France - Germany - Hong Kong - India - Israel - Italy - Japan - Malaysia - Malta - Morocco - Singapore - Spain - Sweden - Switzerland - United Kingdom - United States of America

[www.st.com](http://www.st.com)