

TS920E / TS621E (Under Development)

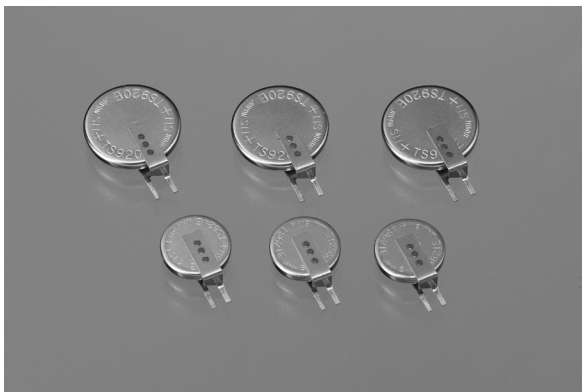

FEATURES

- Low-voltage rechargeable
- High capacity
- Long cycle life: at least 1000 cycles (20% D.O.D.)
- RoHS Compliant

TS lithium rechargeable batteries are high capacity 1.5V type non-reflowable rechargeable batteries that provide sufficient discharge capacity with a charge voltage of less than 2.0V.

SPECIFICATIONS

Type	Nominal Voltage (V)	Charge Voltage ^{*3} (V)	Nominal Capacity (Voltage Range V) (mAh)	Internal Impedance ^{*1} (Ω)	Standard Charge/Discharge Current (mA)	Cycle Life ^{*2} (Time)	Diameter (mm)	Height (mm)	Weight (g)
TS920E	1.5	1.6 to 3.0	5.5 (2.3 to 1.0)	20	0.05	1000 (20% D.O.D.) 100 (100% D.O.D.) ^{*4}	9.5	2.0	0.46
TS621E (Under development)	1.5	1.6 to 3.0	2.5 (2.3 to 1.0)				6.8	2.1	

*1. Value measured using an AC (Alternating Current) method in the fully charged state.

*2. Counts of charge and discharge repetition that maintains about 50% of the minimum guaranteed capacity

*3. A constant voltage charge is recommended, but due to a limit in the charge current, it is necessary to insert a resistor to regulate the charge current.

Please contact us for further details.

If a constant current charge is required, please contact us for more information.

*4. D.O.D. : Depth of Discharge

TS Lithium Rechargeable Batteries are not reflowable. Please mount them on PCB by hand soldering.

CHARACTERISTICS

• Charge/discharge characteristics

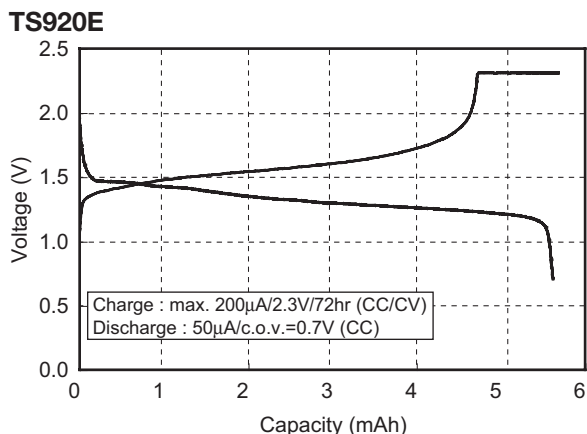

* c.o.v. : Cut off Voltage

CHARACTERISTICS

TS920E

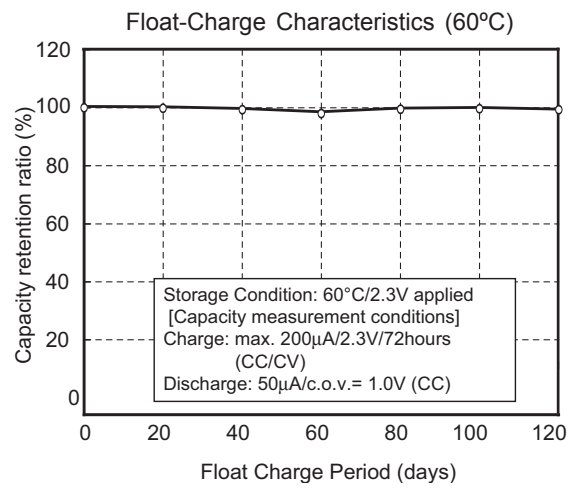
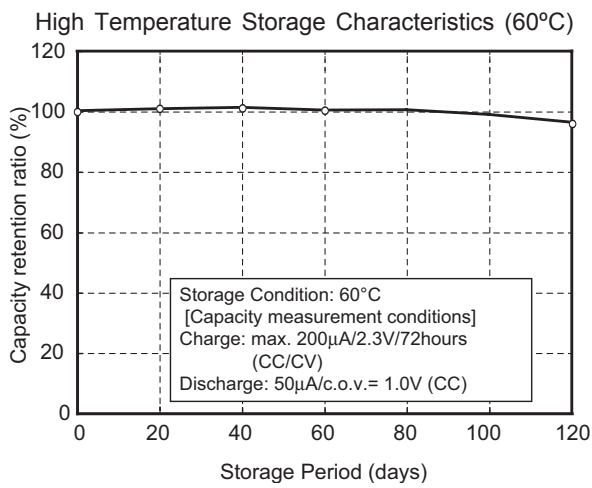
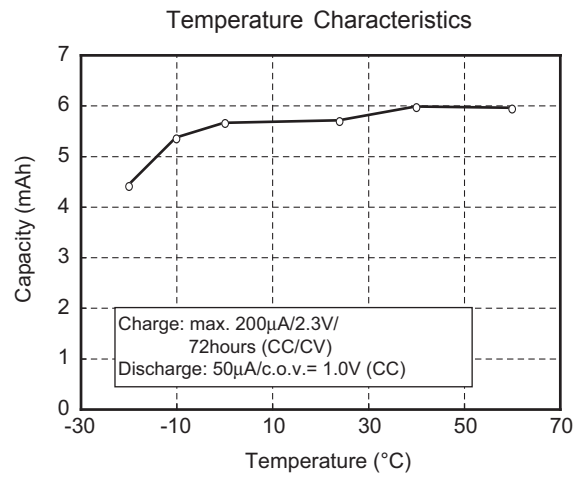
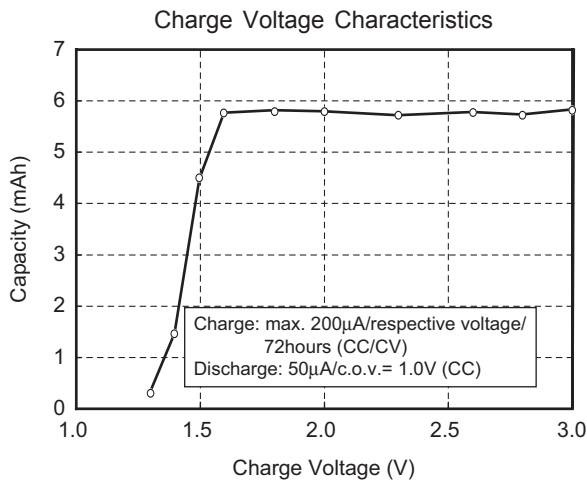

STANDARD TERMINALS

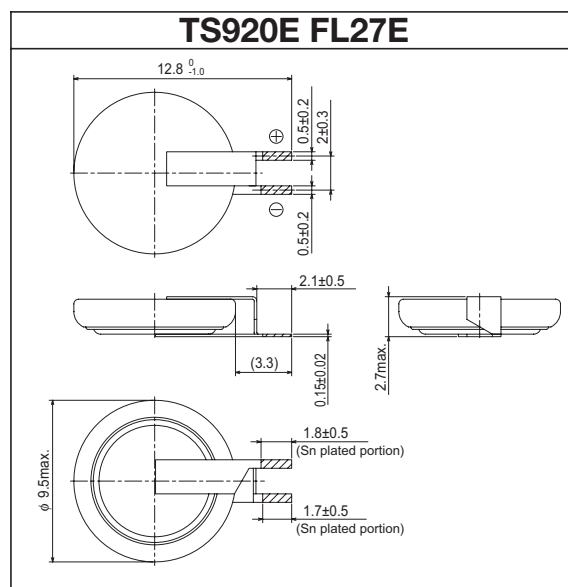

- Units: mm
- The hatched parts are tin plated (Sn: 100%).