

TSA65R190S1

650V 20A N-Channel SJ-MOSFET

General Description

Truesemi SJ-FET is new generation of high voltage MOSFET family that is utilizing an advanced charge balance mechanism for outstanding low on-resistance and lower gate charge performance.

This advanced technology has been tailored to minimize conduction loss, provide superior switching performance, and withstand extreme dv/dt rate and higher avalanche energy.

SJ-FET is suitable for various AC/DC power conversion in switching mode operation for higher efficiency.

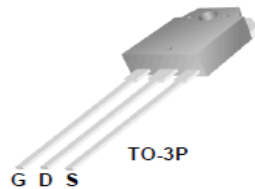

Features

- 700V @T_J = 150 °C
- Typ. R_{DS(on)} = 0.16Ω
- Ultra Low gate charge (typ. Q_g = 70nC)
- 100% avalanche tested

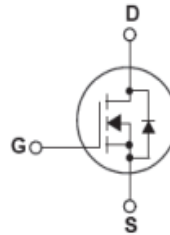

Absolute Maximum Ratings

Symbol	Parameter	Value	Unit
V _{DSS}	Drain-Source Voltage	650	V
I _D	Drain Current -Continuous (TC = 25°C) -Continuous (TC = 100°C)	20* 12.6*	A
I _{DM}	Drain Current – Pulsed (Note 1)	62	A
V _{GSS}	Gate-Source voltage	±30	V
E _{AS}	Single Pulsed Avalanche Energy (Note 2)	485	mJ
I _{AR}	Avalanche Current (Note 1)	3.5	A
E _{AR}	Repetitive Avalanche Energy (Note 1)	1	mJ
dv/dt	Peak Diode Recovery dv/dt (Note 3)	15	V/ns
P _D	Power Dissipation (TC = 25°C) -Derate above 25°C	151 1.67	W W/°C
T _J , T _{STG}	Operating and Storage Temperature Range	-55 to +150	°C
T _L	Maximum Lead Temperature for Soldering Purpose, 1/8" from Case for 5 Seconds	300	°C

* Drain current limited by maximum junction temperature.

Thermal Characteristics

Symbol	Parameter	Value	Unit
R _{θJC}	Thermal Resistance, Junction-to-Case	0.83	°C/W
R _{θCS}	Thermal Resistance, Case-to-Sink Typ.	0.5	°C/W
R _{θJA}	Thermal Resistance, Junction-to-Ambient	62	°C/W

Electrical Characteristics TC = 25 °C unless otherwise noted

Symbol	Parameter	Conditions	Min	Typ	Max	Unit
Off Characteristics						
BV _{DSS}	Drain-Source Breakdown Voltage	V _{GS} = 0V, I _D = 250μA, T _J = 25 °C	650	--	--	V
		V _{GS} = 0V, I _D = 250μA, T _J = 150 °C	--	700	--	V
ΔBV _{DSS} / ΔT _J	Breakdown Voltage Temperature Coefficient	I _D = 250μA, Referenced to 25 °C	--	0.6	--	V/°C
I _{DSS}	Zero Gate Voltage Drain Current	V _{DS} = 600V, V _{GS} = 0V V _{DS} = 600V, T _C = 150 °C	--	-- 10	1 --	μA μA
I _{GSSF}	Gate-Body Leakage Current, Forward	V _{GS} = 30V, V _{DS} = 0V	--	--	100	nA
I _{GSSR}	Gate-Body Leakage Current, Reverse	V _{GS} = -30V, V _{DS} = 0V	--	--	-100	nA
On Characteristics						
V _{GS(th)}	Gate Threshold Voltage	V _{DS} = V _{GS} , I _D = 250μA	2.5	--	4.5	V
R _{DS(on)}	Static Drain-Source On-Resistance	V _{GS} = 10V, I _D = 10A	--	0.16	0.19	Ω
g _{FS}	Forward Trans conductance	V _{DS} = 40V, I _D = 10A (Note 4)	--	16	--	S
Dynamic Characteristics						
C _{ISS}	Input Capacitance	V _{DS} = 25V, V _{GS} = 0V, f = 1.0MHz	--	1440	--	pF
C _{OSS}	Output Capacitance		--	370	--	pF
C _{RSS}	Reverse Transfer Capacitance		--	11	--	pF
t _{d(on)}	Turn-On Delay Time	V _{DD} = 400V, I _D = 10A R _G = 20Ω (Note 4 , 5)	--	15	--	ns
t _r	Turn-On Rise Time		--	11	--	ns
t _{d(off)}	Turn-Off Delay Time		--	110	--	ns
t _f	Turn-Off Fall Time		--	9	--	ns
Q _g	Total Gate Charge	V _{DS} = 480V, I _D = 10A V _{GS} = 10V (Note 4 , 5)	--	70	90	nC
Q _{gs}	Gate-Source Charge		--	7.8	--	nC
Q _{gd}	Gate-Drain Charge		--	9	--	nC
Drain-Source Diode Characteristics and Maximum Ratings						
I _S	Maximum Continuous Drain-Source Diode Forward Current		--	--	20	A
I _{SM}	Maximum Pulsed Drain-Source Diode Forward Current		--	--	60	A
V _{SD}	Drain-Source Diode Forward Voltage	V _{GS} = 0V, I _F = 10A	--	1	1.5	V
t _{rr}	Reverse Recovery Time	V _{GS} = 0V, I _F = 10A di _F /dt = 100A/μs (Note 4)	--	475	--	ns
Q _{rr}	Reverse Recovery Charge		--	5.8	--	μC
I _{rrm}	Peak reverse recovery Current		--	35	--	A

NOTES:

1. Repetitive Rating: Pulse width limited by maximum junction temperature
2. I_{AS} = 3.5A, V_{DD} = 50V, Starting T_J = 25 °C
3. I_{SD} ≤ 20A, di/dt ≤ 200A/μs, V_{DD} ≤ BV_{DSS}, Starting T_J = 25 °C
4. Pulse Test: Pulse width ≤ 300μs, Duty Cycle ≤ 2%
5. Essentially Independent of Operating Temperature Typical Characteristics

Typical Performance Characteristics

Power dissipation

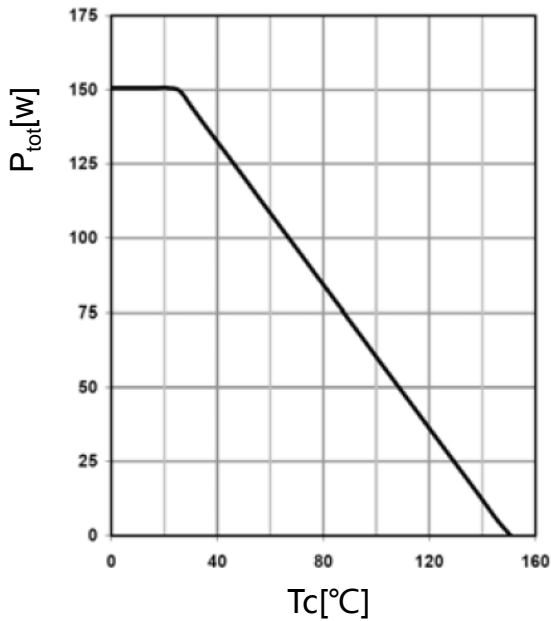

Max. transient thermal impedance

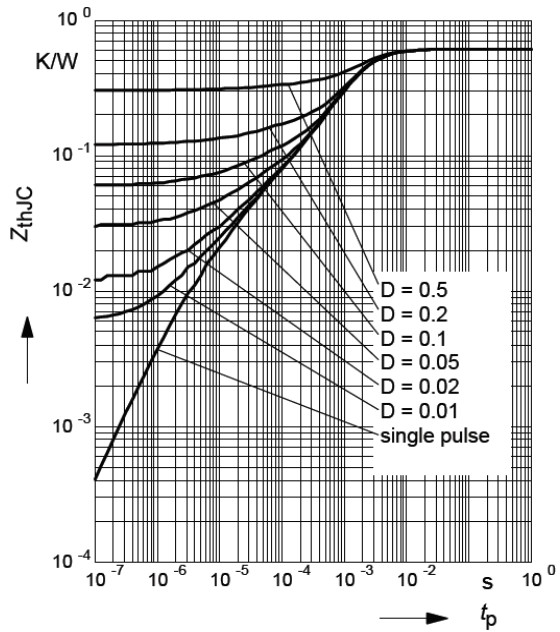

Safe operating area $T_C=25^\circ\text{C}$

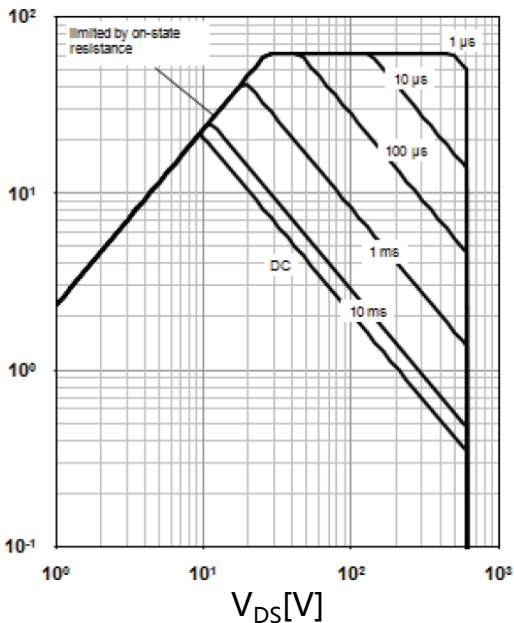

$I_D = f(V_{DS}); T_C = 25^\circ\text{C}; V_{GS} > 7\text{V}; D = 0; \text{parameter } t_p$

Typ. output characteristic

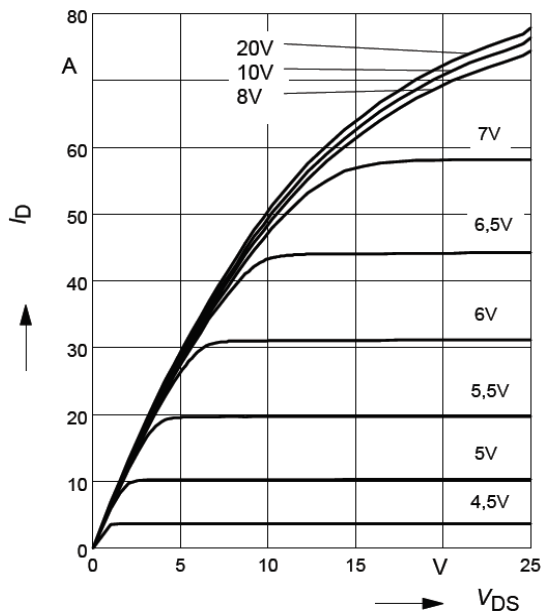

$I_D = f(V_{DS}); T_j = 25^\circ\text{C}; \text{parameter } t_p = 10\mu\text{s}, V_{GS}$

Typical Performance Characteristics

Typ. output characteristic

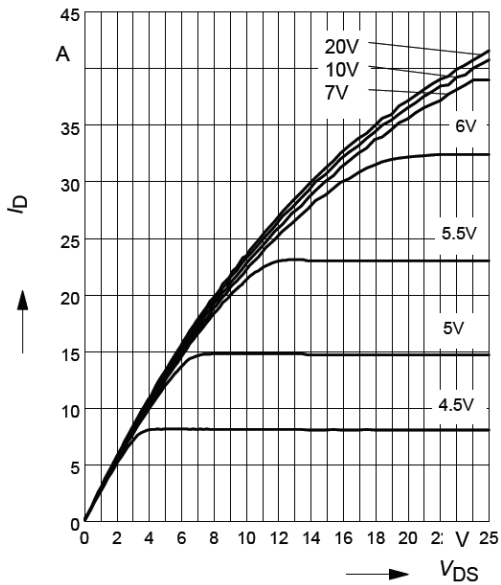

$I_D=f(V_{DS}); T_j=150\text{ }^\circ\text{C};$
parameter $t_p=10\mu\text{s}, V_{GS}$

Typ. Drain-Source on resistance

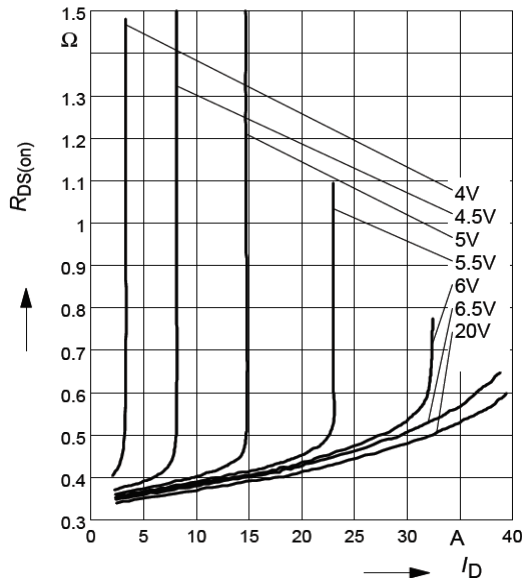

$R_{Dson}=f(I_D); T_j=150\text{ }^\circ\text{C};$ parameter V_{GS}

Typ. Drain-Source on resistance

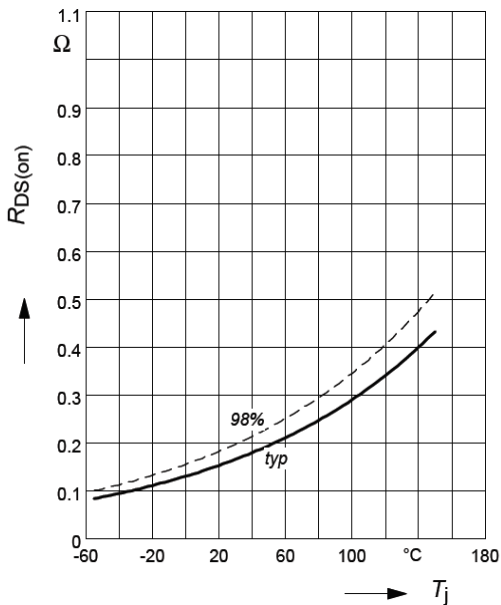

$R_{Dson}=f(T_j); T_j=150\text{ }^\circ\text{C};$ parameter
 $I_D=13.1\text{ A } V_{GS}=10\text{ V}$

Typ. Transfer characteristic

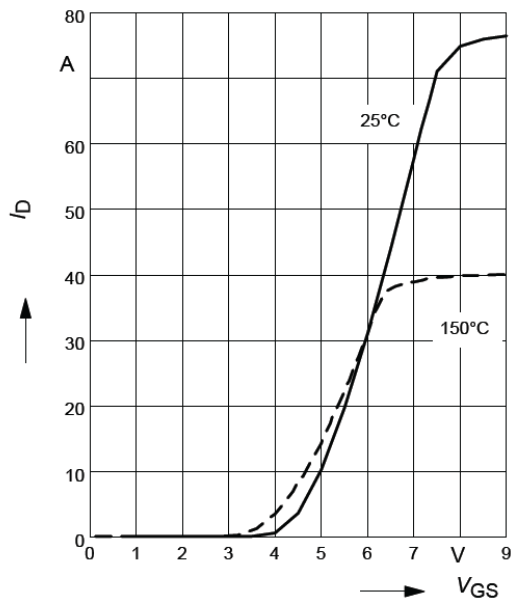

$I_D=f(V_{DS}); V_{DS}>2 \times I_D \times R_{DS(on)max};$
parameter $t_p=10\mu\text{s},$

Typical Performance Characteristics

Forward characteristics of reverse diode

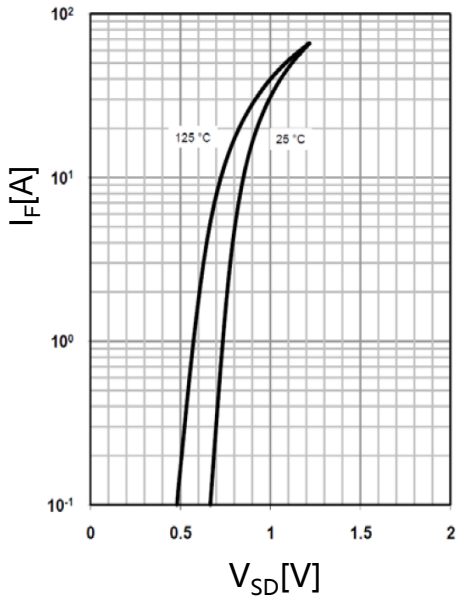

$I_F = f(V_{SD});$ parameter: T_j

Typ. gate charge

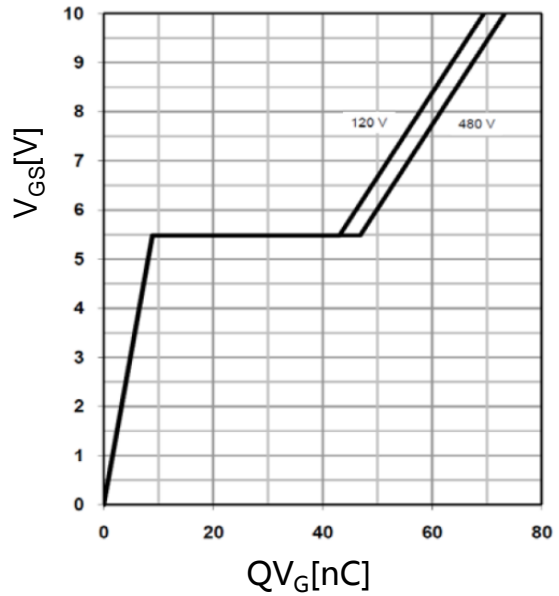

$V_{GS} = f(Q_g), I_D = 11 \text{ A pulsed}$

Avalanche energy

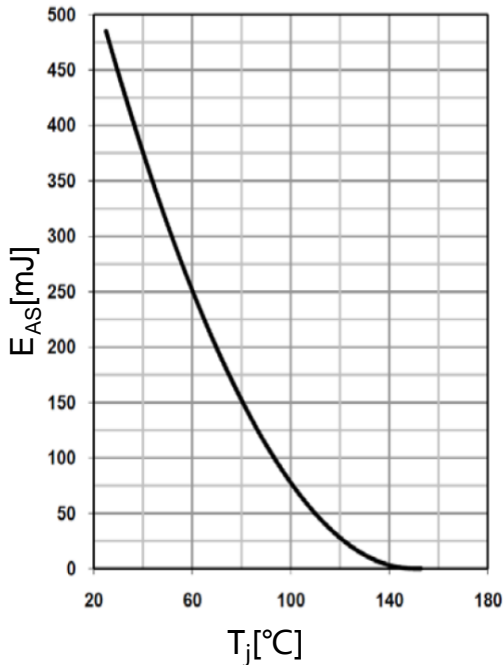

$E_{AS} = f(T_j); I_D = 3.5 \text{ A}; V_{DD} = 50 \text{ V}$

Drain-source breakdown voltage

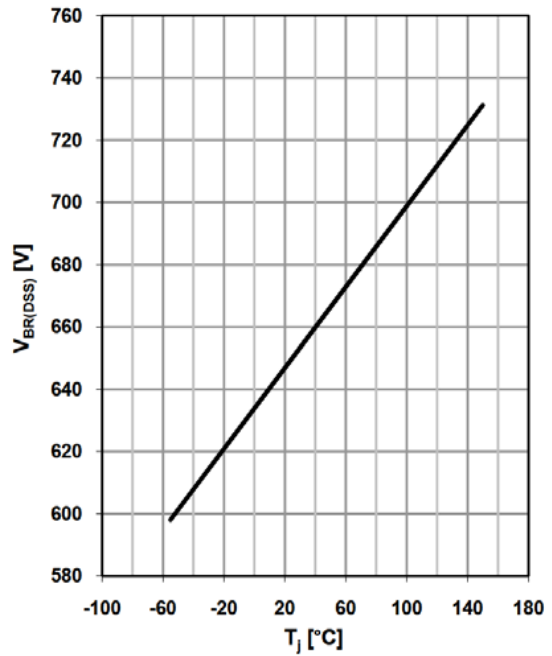

$V_{BR(DSS)} = f(T_j); I_D = 1.0 \text{ mA}$

Typical Performance Characteristics

Typ. capacitances

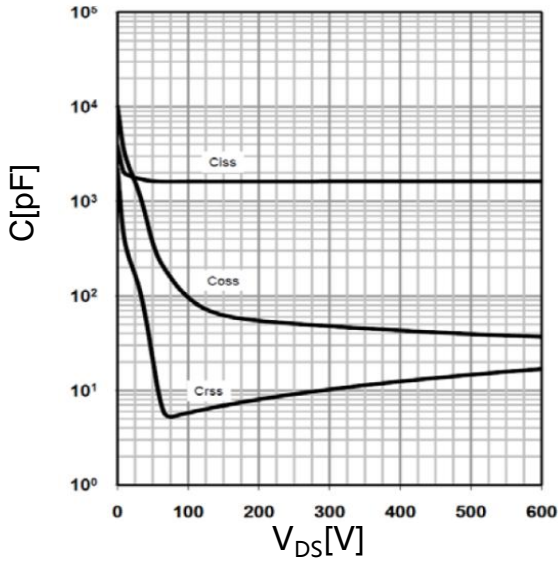

$C=f(V_{DS}); V_{GS}=0 V; f=1 MHz$

Typ. C_{oss} stored energy

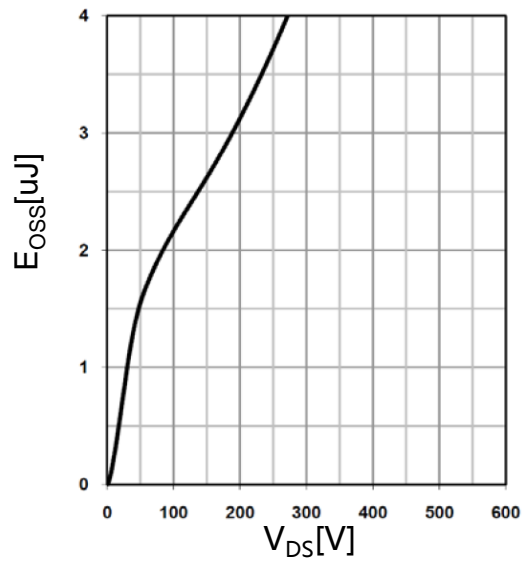

$E_{OSS}=f(V_{DS})$

Test circuits

Switching times test circuit and waveform for inductive load

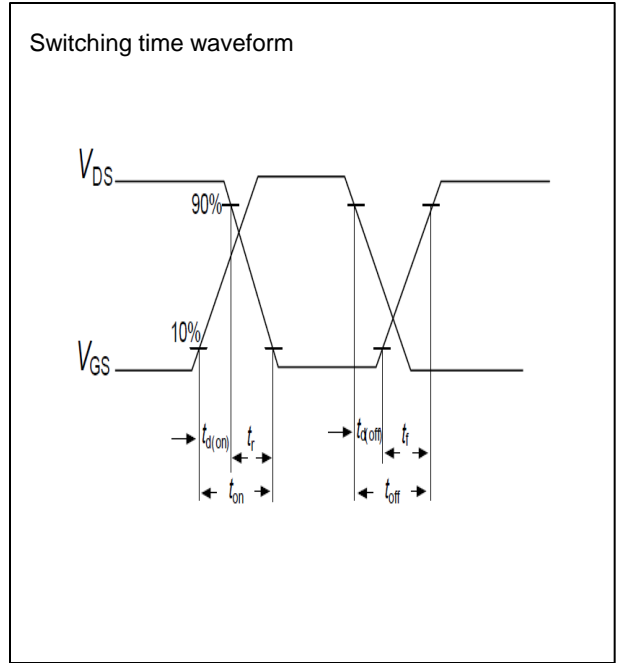
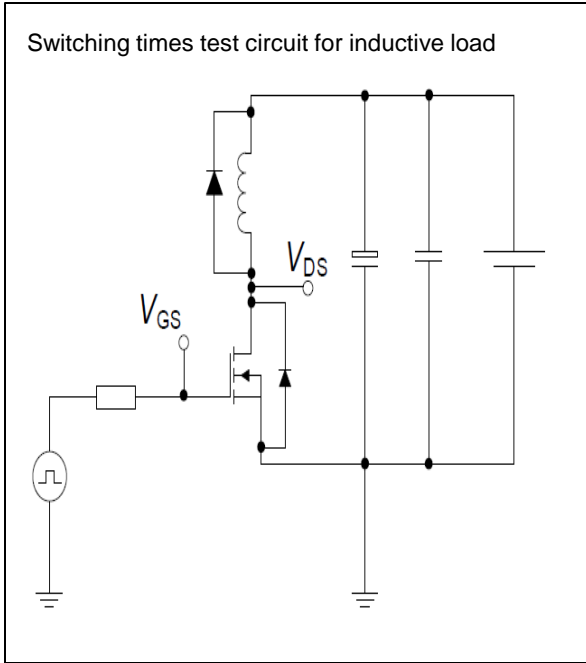

Unclamped inductive load test circuit and waveform

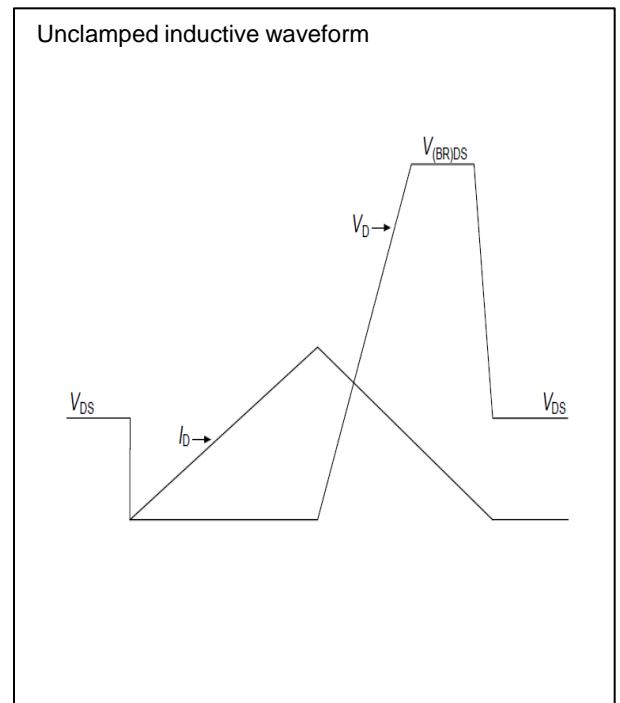
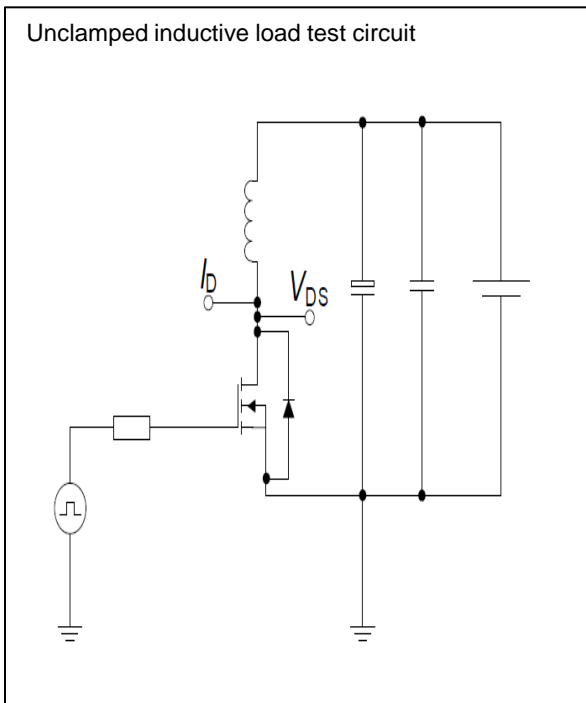

Test circuits

Test circuit and waveform for diode characteristics

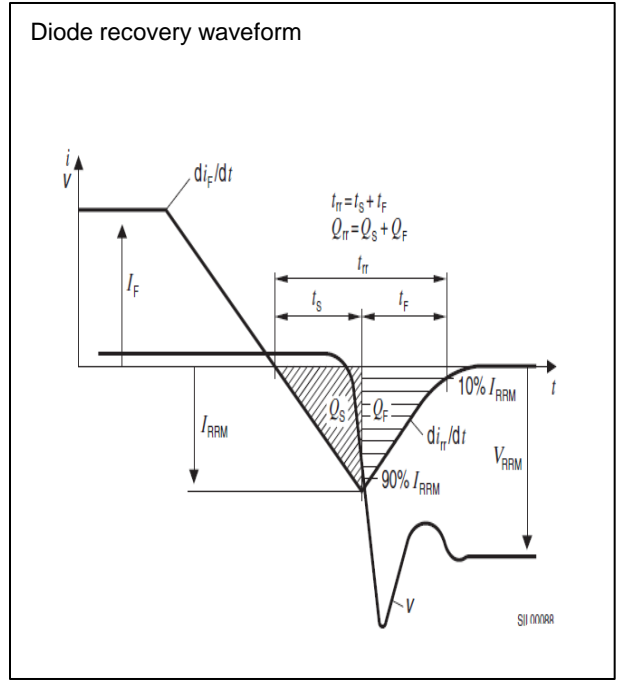
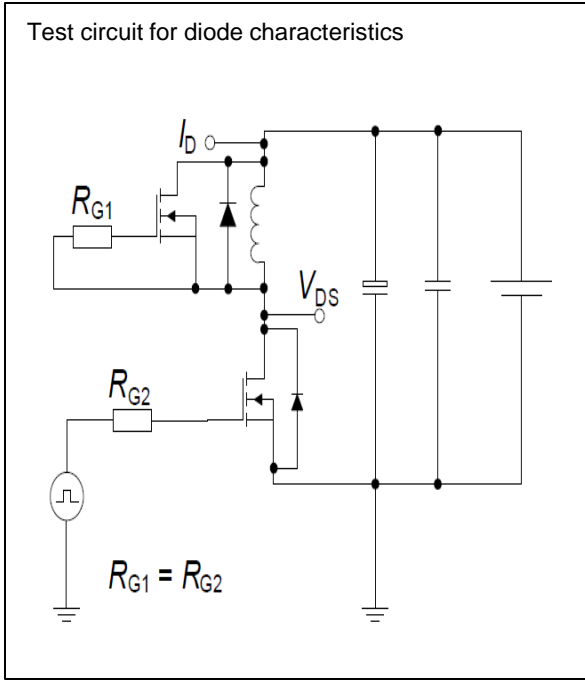

Package Outline TO-3P

TSA65R190S1 650V 20A N-Channel SJ-MOSFET

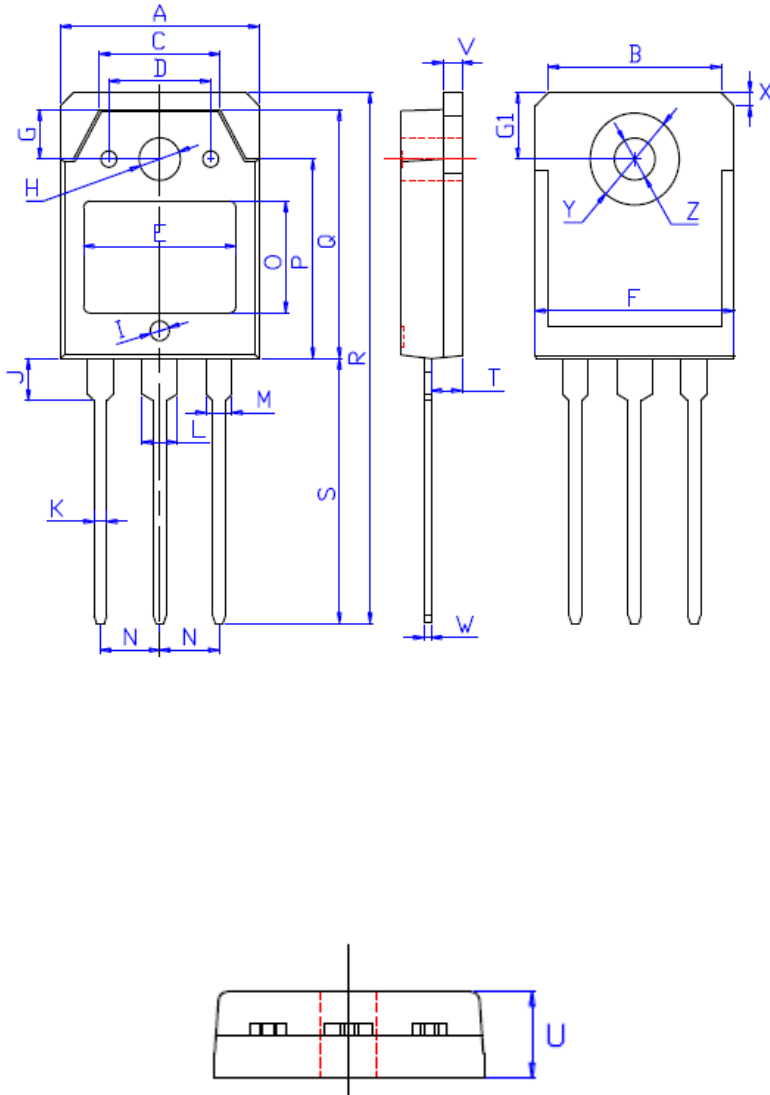

DIM	MILLIMETERS
A	15.60±0.30
B	13.60±0.30
C	9.50±0.30
D	8.00±0.30
E	11.85±0.30
F	15.65±0.30
G	3.80±0.30
G1	5.00±0.30
H	Φ 3.50±0.30
I	Φ 1.50±0.30 深 0.15±0.15
J	3.20±0.30
K	1.00±0.15
L	3.10±0.15
M	2.10±0.15
N	5.45±0.30
O	8.40±0.30
P	13.90±0.30
Q	18.70±0.30
R	40.00±0.60
S	20.00±0.40
T	2.40±0.30
U	4.80±0.30
V	1.50±0.15
W	0.60±0.15
X	1.80±0.40
Y	7.00±0.30
Z	3.20±0.30