

- 2, 2, 3, 3-Input (Active Pullup)
- 2, 2, 3, 3-Input (Passive Pullup)

Features

- VERSATILE CONFIGURATION
- ACTIVE PULLUP ON 325 OUTPUTS
- 5 mA DRIVE CURRENT IN "1" STATE MAKES 325 IDEAL FOR DRIVING LINES UP TO 10 FEET
- 326 OUTPUTS ARE COLLECTOR OR'ABLE

General Description

The 325 and 326 each contain two 2-input gates and two 3-input gates. The active pullup and 5 mA output drive current of the 325 allow it to drive moderately long lines with no loss of noise immunity. The 326 has passive pullup resistors on the chip, so that outputs may be collector OR'd.

Logic Diagram

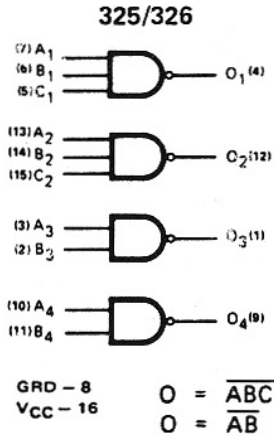

Equivalent Circuits

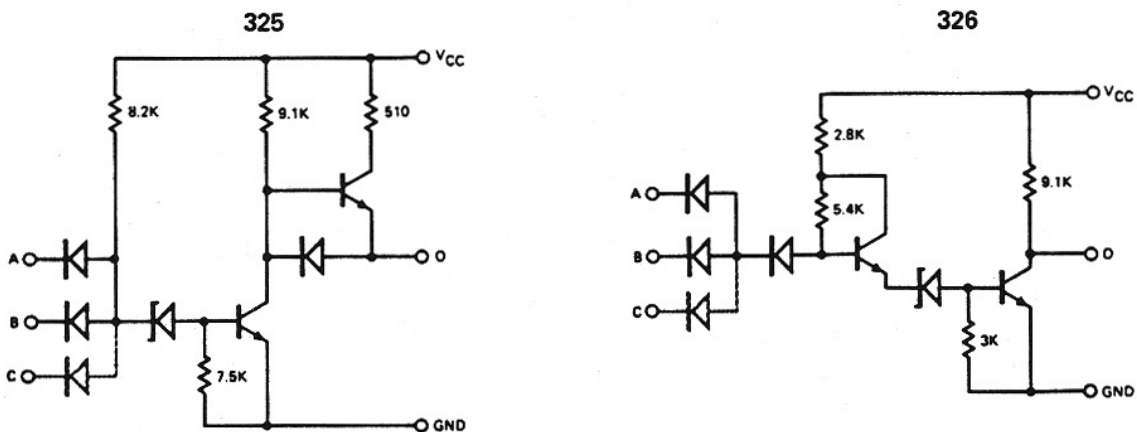

Specifications

325

I_{CC} (WORST-CASE)	15 mA @ 13V, 20 mA @ 16V	
t_{PD} I/O FUNCTION FOR t_{PD}	200 ns A+O-	300 ns A-O+

326

I_{CC} (WORST-CASE)	28 mA @ 13V, 40 mA @ 16V	
t_{PD} I/O FUNCTION FOR t_{PD}	200 ns A+O-	600 ns A-O+

www.DataSheet4U.com

NOTE:

I_{CC} is tested at $V_{CC} + 1$ Volt (+13V for C type and +16V for A type) and is guaranteed across the applicable temp range. t_{PD} is guaranteed at $V_{CC} \pm 1V$ and across the applicable temp range with the output loaded with 5 unit loads. See page 12 for electrical summary data.

Switching Time Waveforms

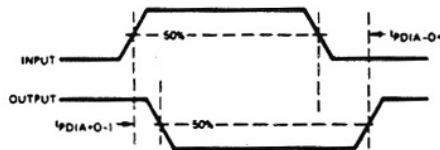

Loading Table

325/326

PINS	FUNCTION	LOADING
A-C 0	Inputs Outputs	1 UL 5 UL 7 UL (326 with supplemental 10K Ω pullup resistor)

Typical Performance Characteristics

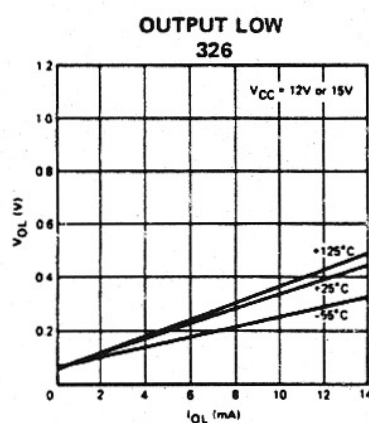
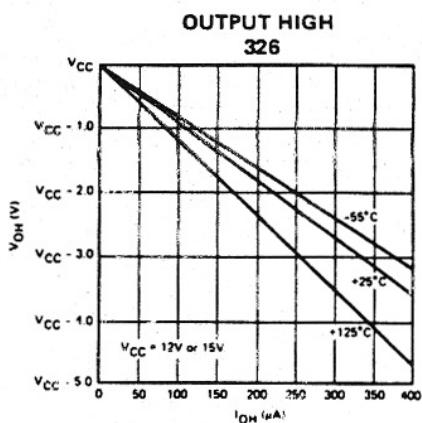
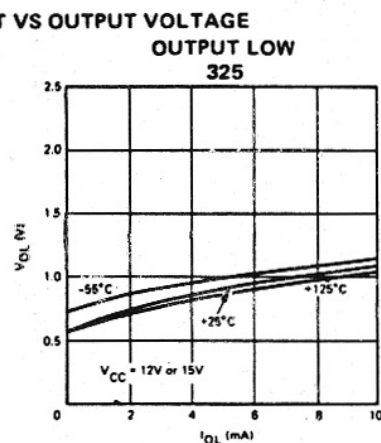
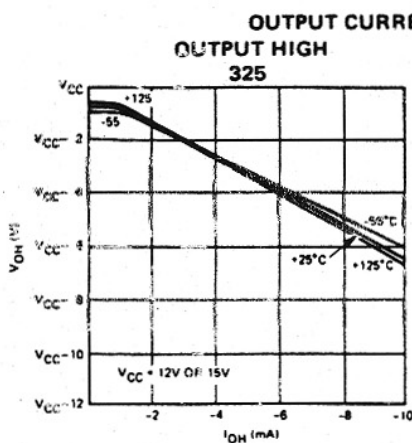
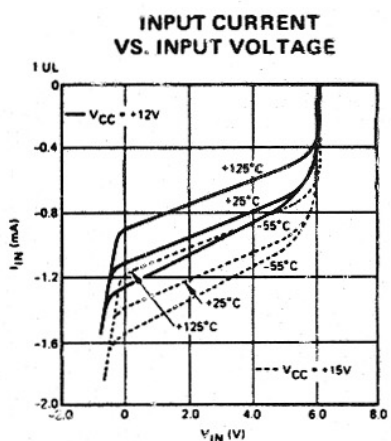

www.DataSheet4U.com

Typical Applications

See applications notes for instructions on selecting external resistors and collector OR'ing passive pullup outputs.

DIGITAL DIFFERENTIAL LINE RECEIVER

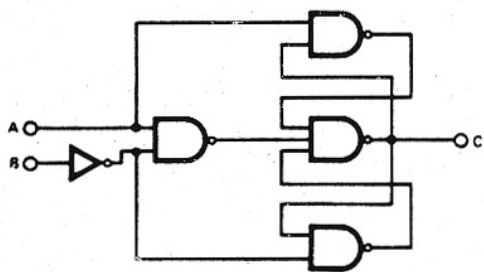

TRUTH TABLE

A	B	C
0	0	N.C.
0	1	0
1	0	1
1	1	N.C.

This circuit accepts only complementary input signals. Any noise common to A and B is rejected, providing additional noise immunity.

POWER-UP RESET CIRCUIT

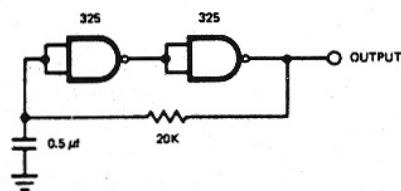

The output goes low briefly when power is first applied, then remains normally high. Use this circuit, for example, to generate a flip-flop reset pulse in systems that must start up at zero.