

TSF70R210S1

700V 20A N-Channel SJ-MOSFET

General Description

Truesemi SJ-FET is new generation of high voltage MOSFET family that is utilizing an advanced charge balance mechanism for outstanding low on-resistance and lower gate charge performance. This advanced technology has been tailored to minimize conduction loss, provide superior switching performance, and withstand extreme dv/dt rate and higher avalanche energy. SJ-FET is suitable for various AC/DC power conversion in switching mode operation for higher efficiency.

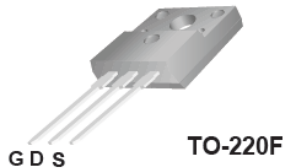

Features

- 750V @ $T_J = 150^\circ\text{C}$
- Typ. $R_{DS(on)} = 0.19\Omega$
- Ultra Low gate charge (typ. $Q_g = 70\text{nC}$)
- 100% avalanche tested



Absolute Maximum Ratings

Symbol	Parameter	Value	Unit
V_{DSS}	Drain-Source Voltage	700	V
I_D	Drain Current	-Continuous ($TC = 25^\circ\text{C}$)	20*
		-Continuous ($TC = 100^\circ\text{C}$)	12.6*
I_{DM}	Drain Current – Pulsed (Note 1)	62*	A
V_{GSS}	Gate-Source voltage	± 30	V
E_{AS}	Single Pulsed Avalanche Energy (Note 2)	485	mJ
I_{AR}	Avalanche Current (Note 1)	3.5	A
E_{AR}	Repetitive Avalanche Energy (Note 1)	1	mJ
dv/dt	Peak Diode Recovery dv/dt (Note 3)	15	V/ns
P_D	Power Dissipation ($TC = 25^\circ\text{C}$)	-Derate above 25°C	35
			0.3
T_J, T_{STG}	Operating and Storage Temperature Range	-55 to +150	$^\circ\text{C}$
T_L	Maximum Lead Temperature for Soldering Purpose, 1/8" from Case for 5 Seconds	300	$^\circ\text{C}$

* Drain current limited by maximum junction temperature.

Thermal Characteristics

Symbol	Parameter	Value	Unit
$R_{\theta JC}$	Thermal Resistance, Junction-to-Case	3.7	$^\circ\text{C/W}$
$R_{\theta CS}$	Thermal Resistance, Case-to-Sink Typ.	--	$^\circ\text{C/W}$
$R_{\theta JA}$	Thermal Resistance, Junction-to-Ambient	80	$^\circ\text{C/W}$

Electrical Characteristics TC = 25 °C unless otherwise noted

Symbol	Parameter	Conditions	Min	Typ	Max	Unit
Off Characteristics						
BV _{DSS}	Drain-Source Breakdown Voltage	V _{GS} = 0V, I _D = 250μA, T _J = 25 °C	700	--	--	V
		V _{GS} = 0V, I _D = 250μA, T _J = 150 °C	--	750	--	V
ΔBV _{DSS} / ΔT _J	Breakdown Voltage Temperature Coefficient	I _D = 250μA, Referenced to 25 °C	--	0.6	--	V/°C
I _{DSS}	Zero Gate Voltage Drain Current	V _{DS} = 700V, V _{GS} = 0V -T _J = 150 °C	--	-- 10	1 --	μA μA
I _{GSSF}	Gate-Body Leakage Current, Forward	V _{GS} = 30V, V _{DS} = 0V	--	--	100	nA
I _{GSSR}	Gate-Body Leakage Current, Reverse	V _{GS} = -30V, V _{DS} = 0V	--	--	-100	nA
On Characteristics						
V _{GS(th)}	Gate Threshold Voltage	V _{DS} = V _{GS} , I _D = 250μA	2.5	--	4.5	V
R _{DS(on)}	Static Drain-Source On-Resistance	V _{GS} = 10V, I _D = 10A	--	0.19	0.21	Ω
g _{FS}	Forward Trans conductance	V _{DS} = 40V, I _D = 10A (Note 4)	--	16	--	S
Dynamic Characteristics						
C _{iss}	Input Capacitance	V _{DS} = 25V, V _{GS} = 0V, f = 1.0MHz	--	1440	--	pF
C _{oss}	Output Capacitance		--	370	--	pF
C _{rss}	Reverse Transfer Capacitance		--	11	--	pF
Switching Characteristics						
t _{d(on)}	Turn-On Delay Time	V _{DD} = 400V, I _D = 10A R _G = 20Ω (Note 4, 5)	--	15	--	ns
t _r	Turn-On Rise Time		--	11	--	ns
t _{d(off)}	Turn-Off Delay Time		--	110	--	ns
t _f	Turn-Off Fall Time		--	9	--	ns
Q _g	Total Gate Charge	V _{DS} = 480V, I _D = 10A V _{GS} = 10V (Note 4, 5)	--	70	90	nC
Q _{gs}	Gate-Source Charge		--	7.8	--	nC
Q _{gd}	Gate-Drain Charge		--	9	--	nC
Drain-Source Diode Characteristics and Maximum Ratings						
I _S	Maximum Continuous Drain-Source Diode Forward Current		--	--	20	A
I _{SM}	Maximum Pulsed Drain-Source Diode Forward Current		--	--	60	A
V _{SD}	Drain-Source Diode Forward Voltage	V _{GS} = 0V, I _F = 10A	--	1	1.5	V
t _{rr}	Reverse Recovery Time	V _{GS} = 0V, I _F = 10A di _F /dt = 100A/μs (Note 4)	--	475	--	ns
Q _{rr}	Reverse Recovery Charge		--	5.8	--	μC
I _{rrm}	Peak reverse recovery Current				35	--

NOTES:

1. Repetitive Rating: Pulse width limited by maximum junction temperature
2. I_{AS}=3.5A, V_{DD}=50V, Starting T_J=25 °C
3. I_{SD}≤20A, di/dt ≤ 200A/us, V_{DD} ≤ BV_{DSS}, Starting T_J = 25 °C
4. Pulse Test: Pulse width ≤ 300us, Duty Cycle ≤ 2%
5. Essentially Independent of Operating Temperature Typical Characteristics

Typical Performance Characteristics

Power dissipation

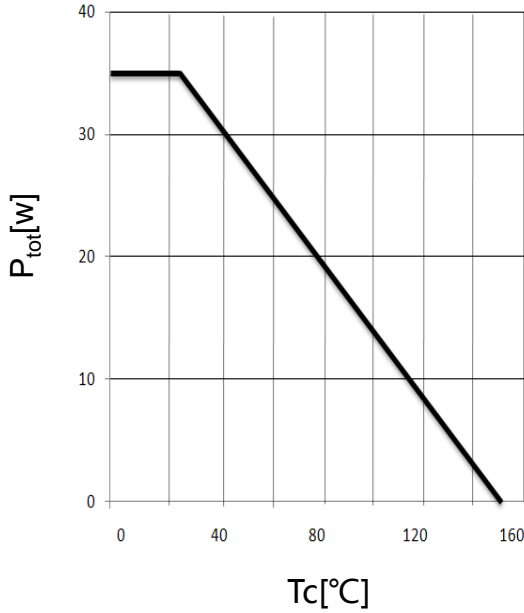

Max. transient thermal impedance

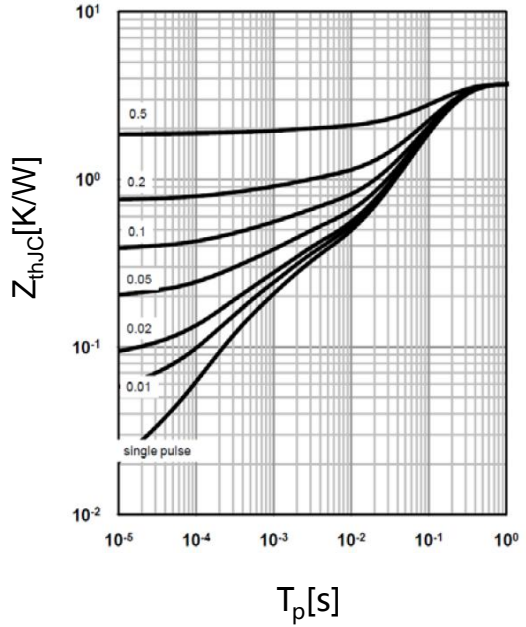

Safe operating area $T_C=25\text{ }^\circ\text{C}$

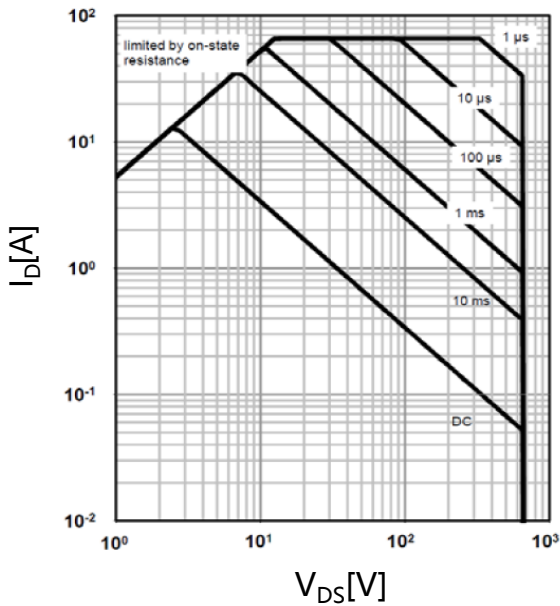

$I_D=f(V_{DS}); T_C=25\text{ }^\circ\text{C}; V_{GS} > 7V;$
 $D=0;$ parameter t_p

Safe operating area $T_C=80\text{ }^\circ\text{C}$

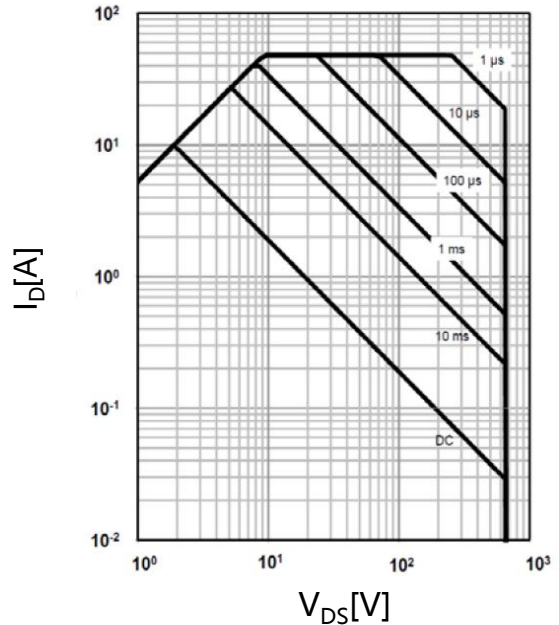

$I_D=f(V_{DS}); T_C=80\text{ }^\circ\text{C}; V_{GS} > 7V;$
 $D=0;$ parameter t_p

Typical Performance Characteristics

Typ. output characteristics $T_j=25\text{ }^\circ\text{C}$

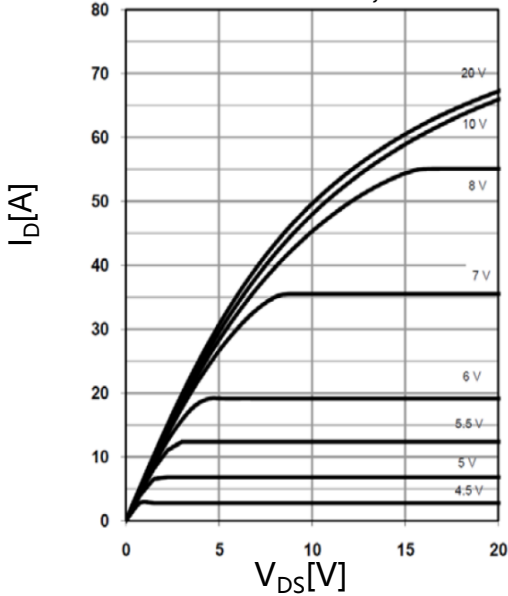

$I_D=f(V_{DS}); T_j=25\text{ }^\circ\text{C}$; parameter: V_{GS}

Typ. output characteristics $T_j=125\text{ }^\circ\text{C}$

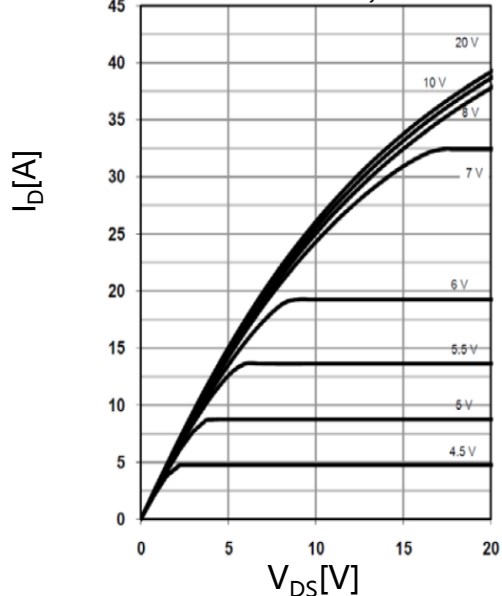

$I_D=f(V_{DS}); T_j=125\text{ }^\circ\text{C}$; parameter: V_{GS}

Typ. drain-source on-state resistance

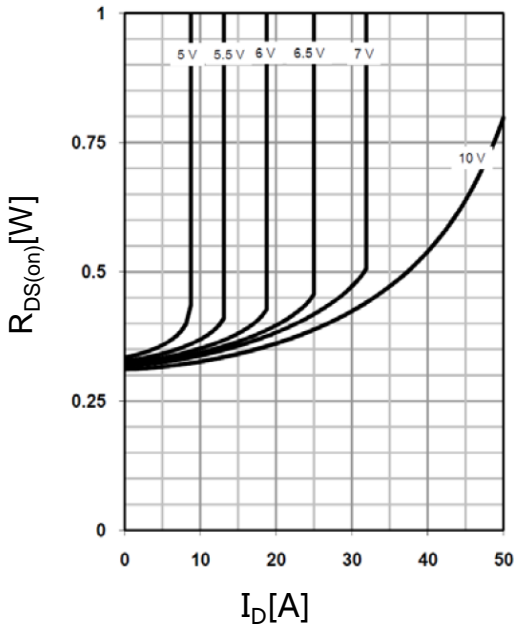

$R_{DS(on)}=f(I_D); T_j=125\text{ }^\circ\text{C}$;
parameter: V_{GS}

Typ. drain-source on-state resistance

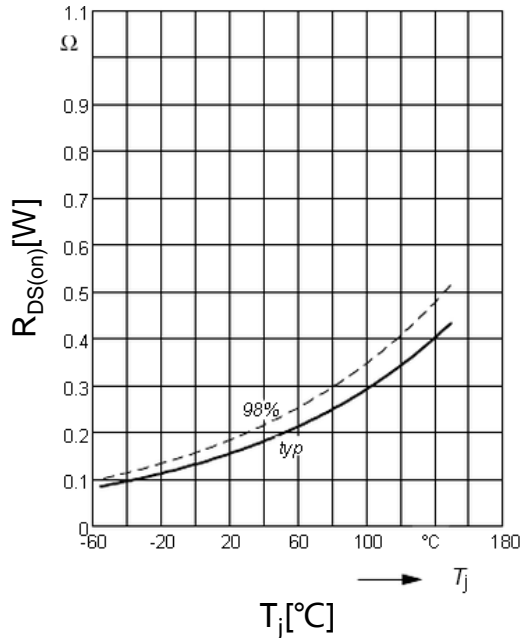

$R_{DS(on)}=f(T_j); I_D=7.3\text{ A}; V_{GS}=10\text{ V}$

Typical Performance Characteristics

Typ. transfer characteristics

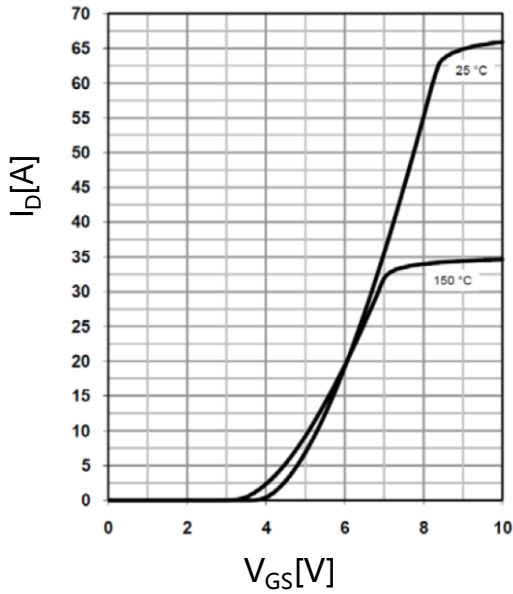

$I_D = f(V_{GS}); V_{DS} = 20V$

Typ. gate charge

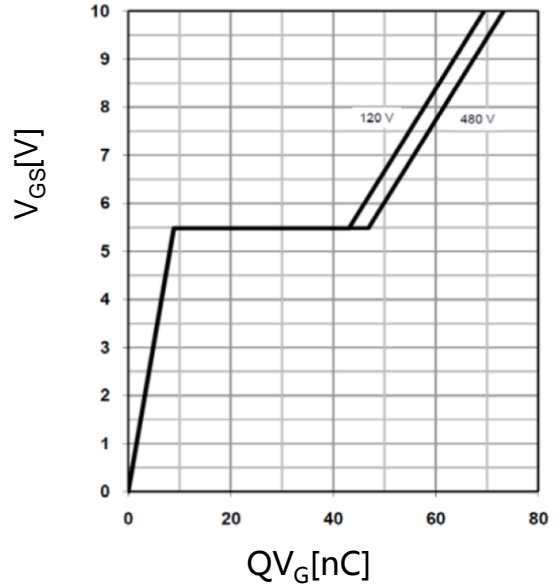

$V_{GS} = f(Q_g), I_D = 11A \text{ pulsed}$

Avalanche energy

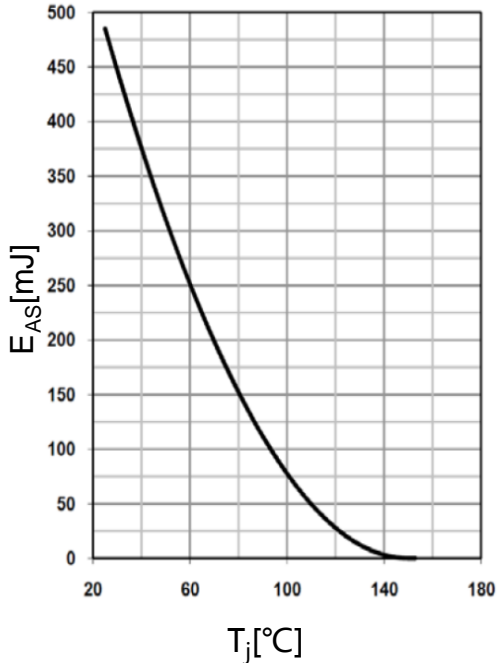

$E_{AS} = f(T_j); I_D = 3.5A; V_{DD} = 50V$

Drain-source breakdown voltage

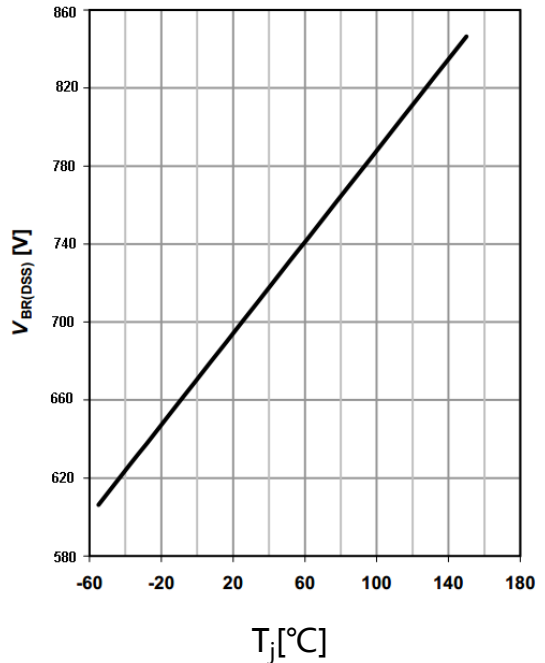

$V_{BR(DSS)} = f(T_j); I_D = 1.0mA$

Typical Performance Characteristics

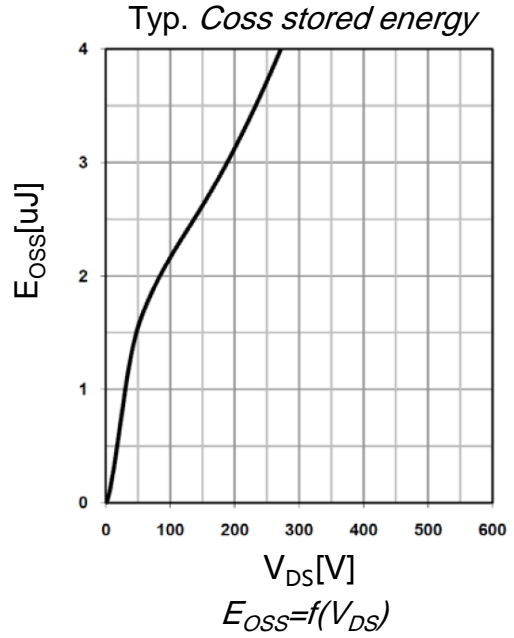
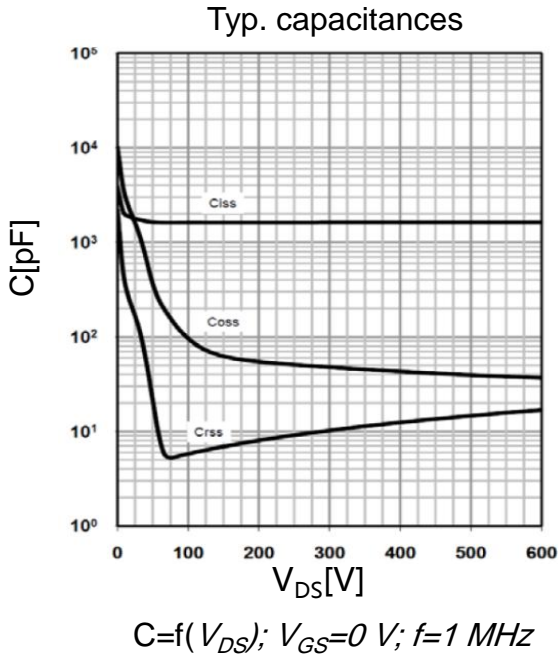

Forward characteristics of reverse diode

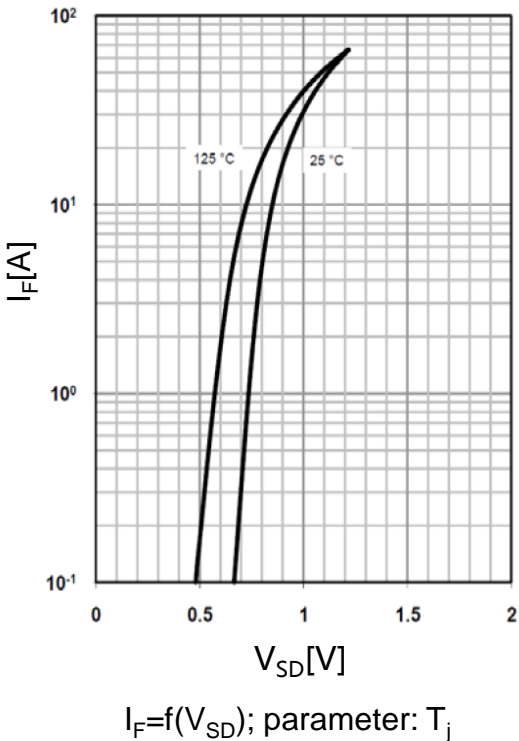

Test circuits

Switching times test circuit and waveform for inductive load

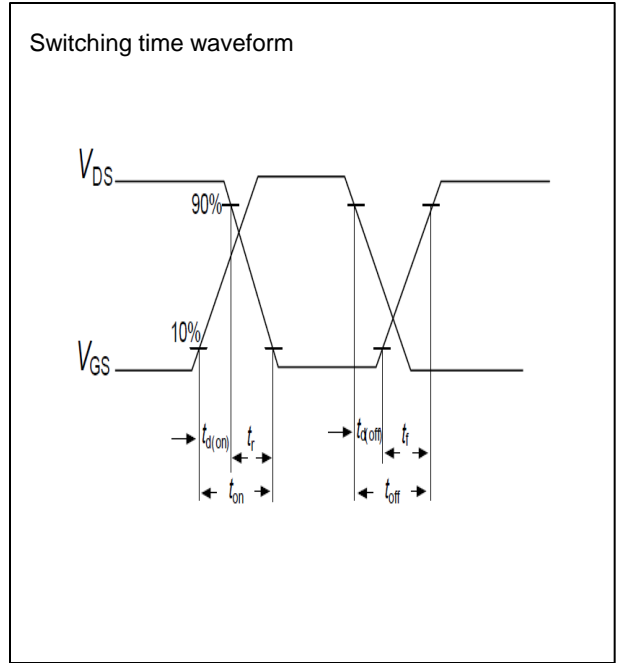
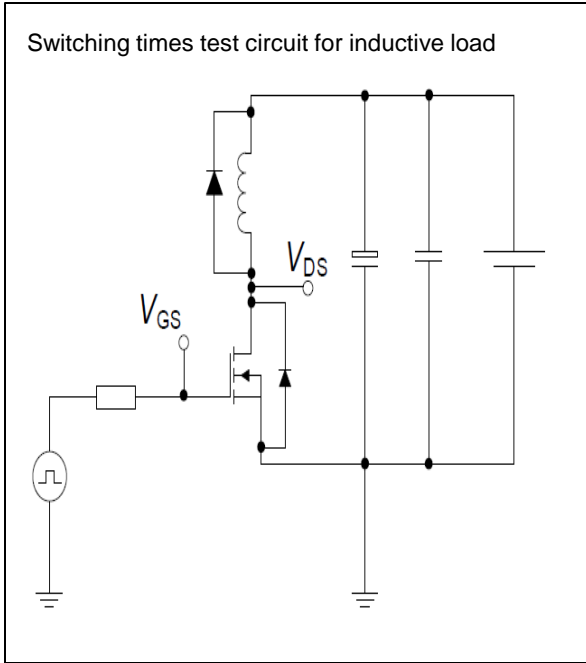

Unclamped inductive load test circuit and waveform

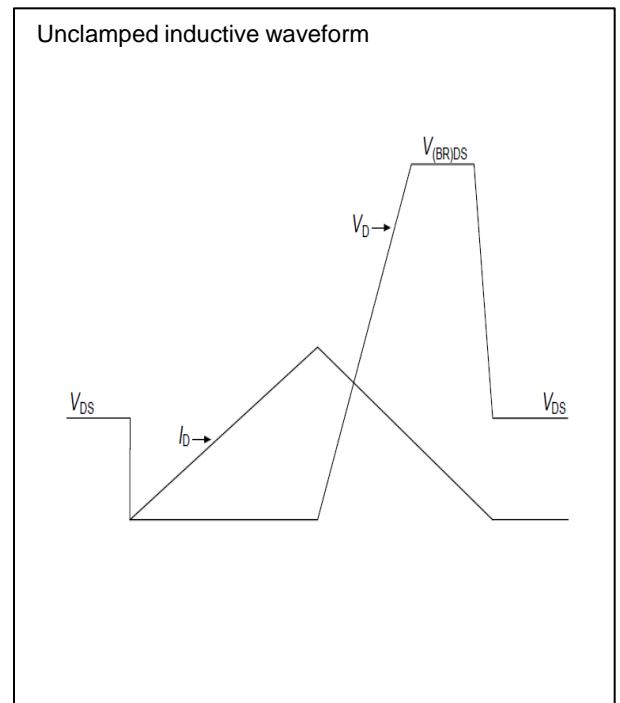
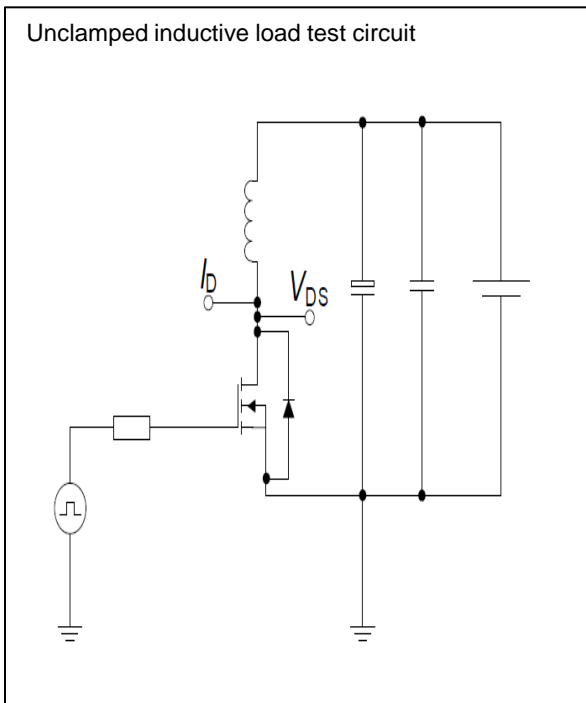

Test circuits

Test circuit and waveform for diode characteristics

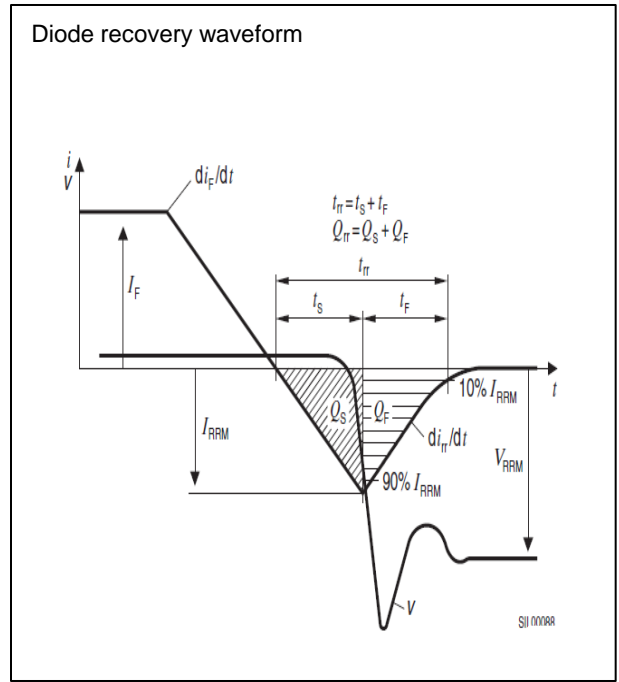
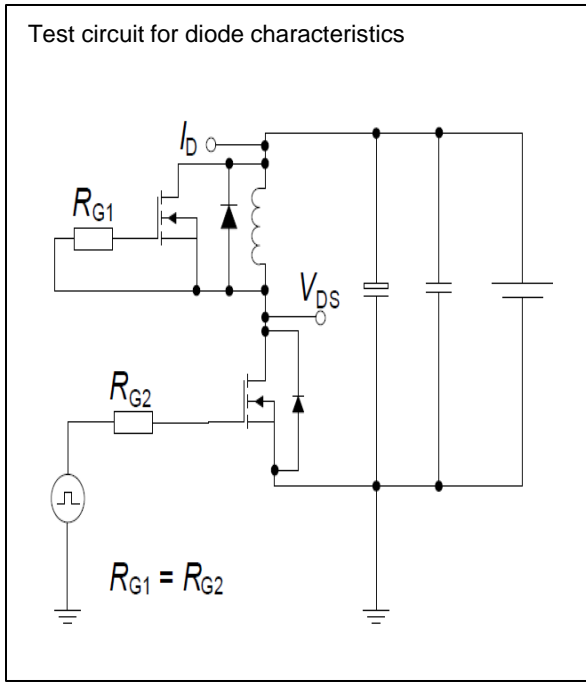

Package Outline TO-220F

TSF70R210S1 700V 20A N-Channel SJ-MOSFET

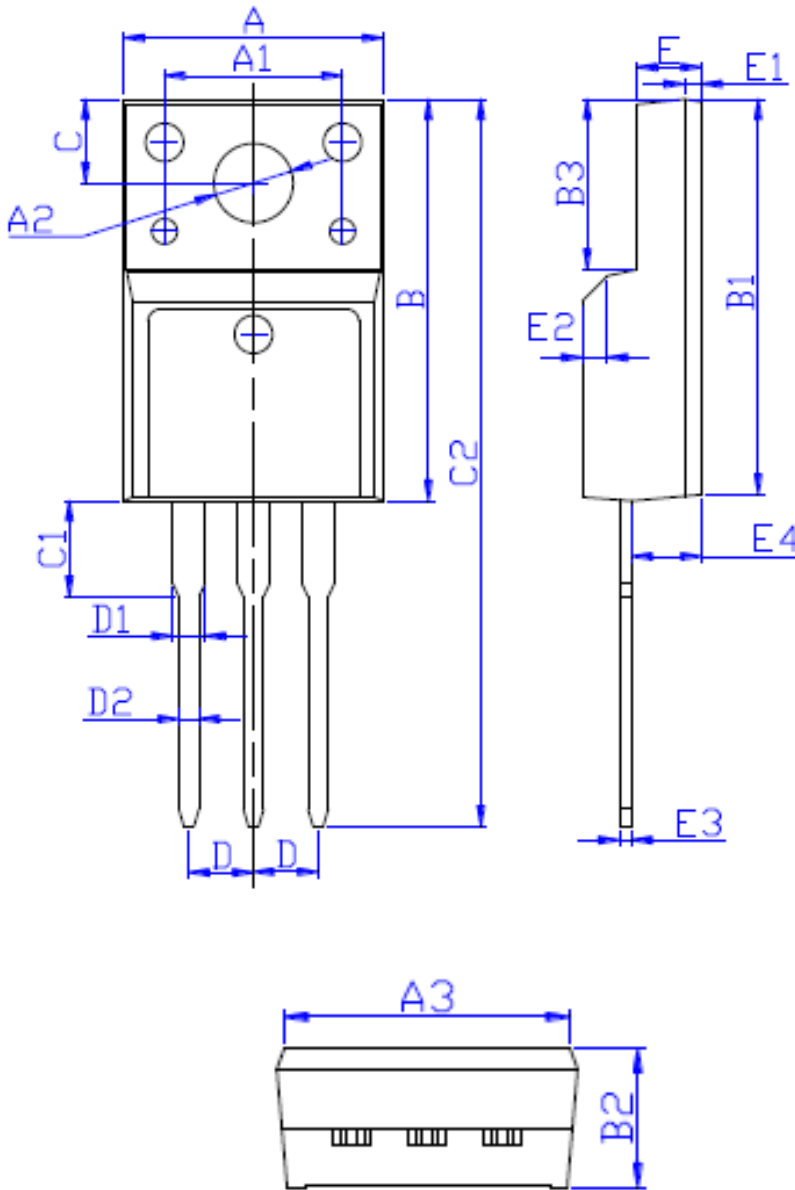

DIM	MILLIMETERS
A	10.16 ± 0.30
A1	7.00 ± 0.20
A2	3.12 ± 0.20
A3	9.70 ± 0.30
B	15.90 ± 0.50
B1	15.60 ± 0.50
B2	4.70 ± 0.30
B3	6.70 ± 0.30
C	3.30 ± 0.25
C1	3.25 ± 0.30
C2	28.70 ± 0.50
D	Typical 2.54
D1	1.47 (MAX)
D2	0.80 ± 0.20
E	2.55 ± 0.25
E1	0.70 ± 0.25
E2	1.0 × 45°
E3	0.50 ± 0.20
E4	2.75 ± 0.30