

### TO-3PN

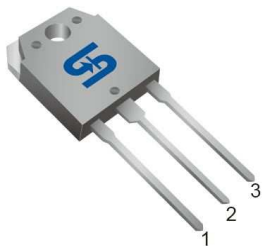

#### Pin Definition:

1. Gate
2. Collector
3. Emitter

### PRODUCT SUMMARY

$V_{CES}$ (V)	$V_{GES}$ (V)	$I_C$ (A)
1200	$\pm 20$	15

### General Description

The TSG15N120CN using proprietary trench design and advanced NPT technology, the 1200V NPT IGBT offers superior conduction and switching performances, high avalanche ruggedness and easy parallel operation. This device is well suited for the resonant or soft switching application such as induction heating, microwave oven, etc.

### Features

- 1200V NPT Trench Technology
- High Speed Switching
- Low Conduction Loss

### Ordering Information

Part No.	Package	Packing
TSG15N120CN C0	TO-3PN	30pcs / Tube

### Block Diagram

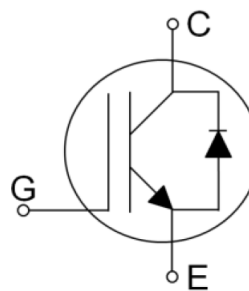

NPT Trench IGBT

### Absolute Maximum Rating ( $T_A=25^\circ\text{C}$ unless otherwise noted)

Parameter	Symbol	Limit	Unit	
Collector-Emitter Voltage	$V_{CES}$	1200	V	
Gate-Emitter Voltage	$V_{GES}$	$\pm 20$	V	
Continuous Current	$I_C$	$T_C=25^\circ\text{C}$	30	A
		$T_C=100^\circ\text{C}$	15	A
Pulsed Collector Current *	$I_{CM}$	45	A	
Diode Forward Current ( $T_C=100^\circ\text{C}$ )	$I_F$	15	A	
Diode Pulse Forward Current	$I_{FM}$	45	A	
Max Power Dissipation	$P_D$	$T_J=25^\circ\text{C}$	184	W
		$T_J=100^\circ\text{C}$	74	
Operating Junction Temperature	$T_J$	-55 to +150	$^\circ\text{C}$	
Storage Temperature Range	$T_{STG}$	-55 to +150	$^\circ\text{C}$	

\* Repetitive rating: Pulse width limited by max. junction temperature

### Thermal Performance

Parameter	Symbol	Limit	Unit
Thermal Resistance - Junction to Case	IGBT	0.68	°C/W
	DIODE	3.7	
Thermal Resistance - Junction to Ambient	$R_{\theta JA}$	40	

### Electrical Specifications (T<sub>C</sub>=25°C unless otherwise noted)

Parameter	Conditions	Symbol	Min	Typ	Max	Unit	
<b>Static</b>							
Collector-Emitter Breakdown Voltage	V <sub>GE</sub> = 0V, I <sub>C</sub> = 1mA	BV <sub>CES</sub>	1200	--	--	V	
Zero Gate Voltage Collector Current	V <sub>CE</sub> = 1200V, V <sub>GE</sub> = 0V	I <sub>CES</sub>	--	--	1	mA	
Gate-Emitter Leakage Current	V <sub>GE</sub> = 20V, V <sub>CE</sub> = 0V	I <sub>GES</sub>	--	--	±250	nA	
Gate-Emitter Threshold Voltage	V <sub>GE</sub> = V <sub>CE</sub> , I <sub>C</sub> = 15mA	V <sub>GE(TH)</sub>	3.0	5.0	7.0	V	
Collector-Emitter Saturation Voltage	V <sub>GE</sub> = 15V, I <sub>C</sub> = 15A, T <sub>J</sub> = 25°C	V <sub>CE(SAT)</sub>	--	1.9	--	V	
	V <sub>GE</sub> = 15V, I <sub>C</sub> = 15A, T <sub>J</sub> = 125°C	V <sub>CE(SAT)</sub>	--	2.2	--	V	
<b>Dynamic</b>							
Input Capacitance	V <sub>CE</sub> = 30V, V <sub>GE</sub> = 0V, f = 1.0MHz	C <sub>IES</sub>	--	2650	--	pF	
Output Capacitance		C <sub>OES</sub>	--	150	--		
Reverse Transfer Capacitance		C <sub>RES</sub>	--	96	--		
<b>Switching</b>							
Turn-On Delay Time	V <sub>CC</sub> = 600V, I <sub>C</sub> = 15A, R <sub>G</sub> = 10Ω, V <sub>GE</sub> = 15V Inductive Load, T <sub>J</sub> = 25°C	t <sub>d(on)</sub>	--	34	--	nS	
Rise Time		t <sub>r</sub>	--	106	--		
Turn-Off Delay Time		t <sub>d(off)</sub>	--	192	--		
Fall Time		t <sub>f</sub>	--	94	--		
Turn-On Switching Loss		Inductive Load, T <sub>J</sub> = 25°C	E <sub>on</sub>	--	2.10	--	mJ
Turn-Off Switching Loss			E <sub>off</sub>	--	0.54	--	
Total Switching Loss			E <sub>ts</sub>	--	2.64	--	
Turn-On Delay Time		V <sub>CC</sub> = 600V, I <sub>C</sub> = 15A, R <sub>G</sub> = 10Ω, V <sub>GE</sub> = 15V Inductive Load, T <sub>J</sub> = 125°C	t <sub>d(on)</sub>	--	31	--	nS
Rise Time			t <sub>r</sub>	--	107	--	
Turn-Off Delay Time	t <sub>d(off)</sub>		--	204	--		
Fall Time	t <sub>f</sub>		--	86	--		
Turn-On Switching Loss	Inductive Load, T <sub>J</sub> = 125°C		E <sub>on</sub>	--	2.20	--	mJ
Turn-Off Switching Loss			E <sub>off</sub>	--	0.93	--	
Total Switching Loss			E <sub>ts</sub>	--	3.13	--	
Total Gate Charge	V <sub>CC</sub> = 600V, I <sub>C</sub> = 15A, V <sub>GE</sub> = 15V		Q <sub>g</sub>	--	110	--	nC
Gate-Emitter Charge			Q <sub>ge</sub>	--	15	--	
Gate-Collector Charge		Q <sub>gc</sub>	--	40	--		

**Electrical Specifications of the DIODE** ( $T_c=25^\circ\text{C}$  unless otherwise noted)

Parameter	Conditions		Symbol	Min	Typ	Max	Unit
Diode Forward Voltage	$I_F = 15\text{A}$ ,	$T_J=25^\circ\text{C}$	$V_{FM}$	--	2.0	--	V
		$T_J=125^\circ\text{C}$		--	2.2	--	V
Reverse Recovery Time	$I_F = 15\text{A}$ , $di/dt=200\text{A}/\mu\text{s}$	$T_J=25^\circ\text{C}$	$t_{fr}$	--	200	--	ns
		$T_J=125^\circ\text{C}$		--	270	--	
Reverse Recovery Current		$T_J=25^\circ\text{C}$	$I_{fr}$	--	22	--	A
		$T_J=125^\circ\text{C}$		--	28	--	
Reverse Recovery Charge	$T_J=25^\circ\text{C}$	$Q_{fr}$	--	2230	--	nC	
	$T_J=125^\circ\text{C}$		--	3750	--		

**Electrical Characteristics Curve** ( $T_c = 25^\circ\text{C}$ , unless otherwise noted)

**Output Characteristics**

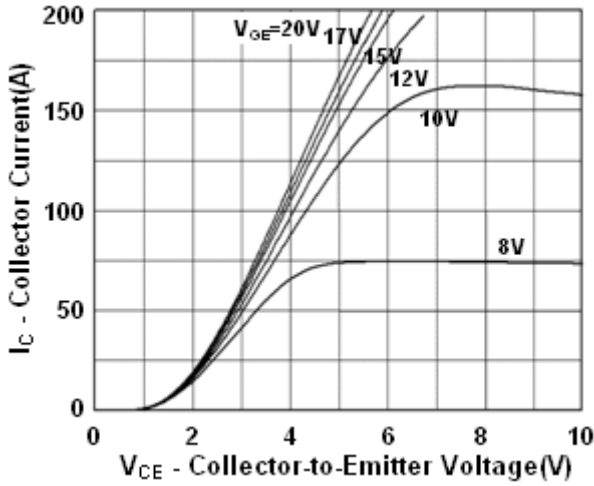

**Saturation voltage characteristics**

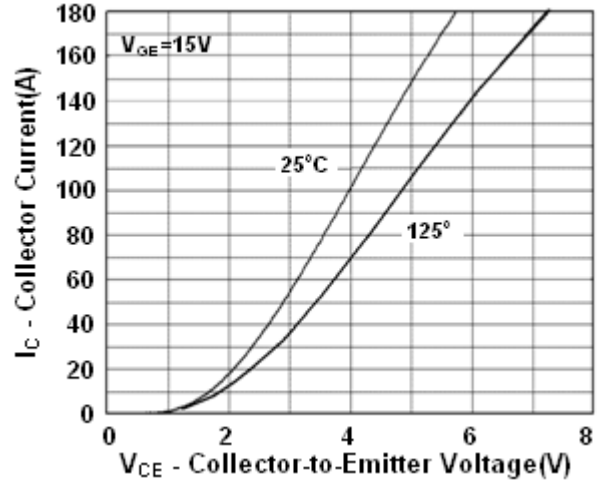

**Saturation voltage vs. collector current**

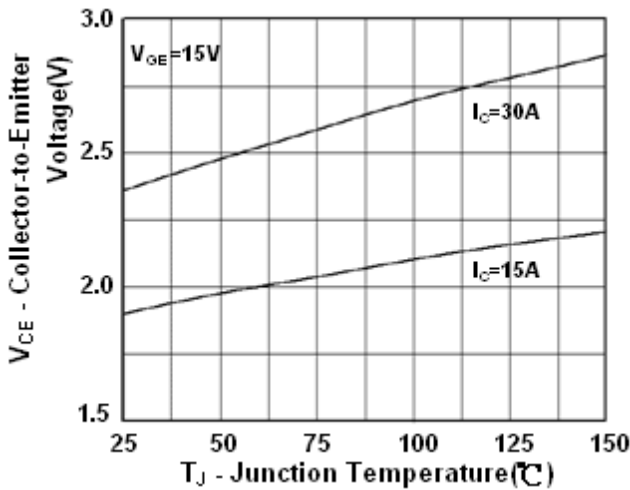

**Saturation voltage vs. gate bias**

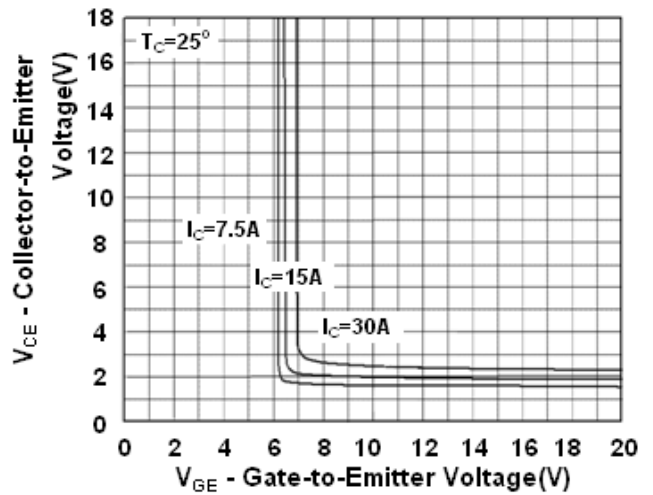

**Saturation voltage vs. gate bias**

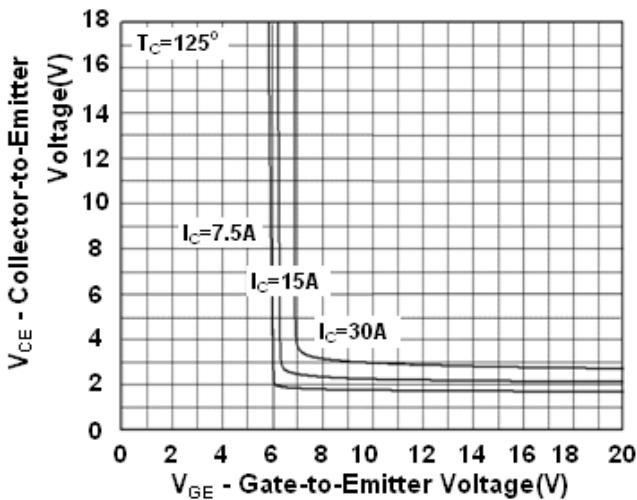

**Capacitance characteristics**

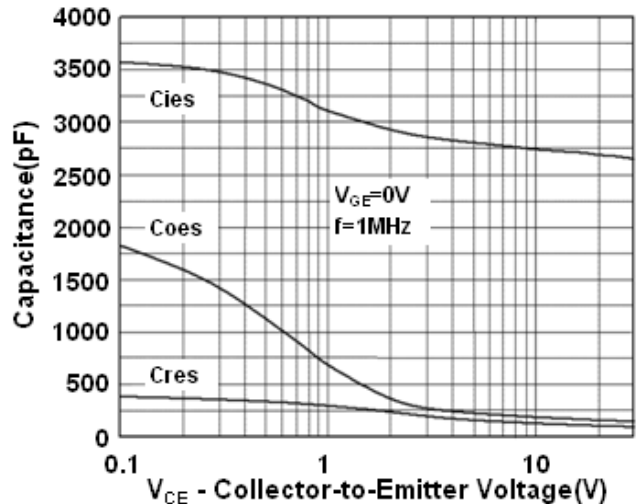

**Electrical Characteristics Curve** ( $T_a = 25^\circ\text{C}$ , unless otherwise noted)

**Turn on time vs. gate resistance**

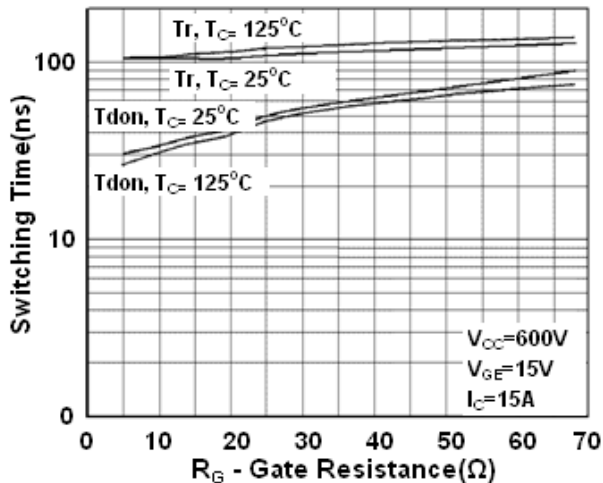

**Turn off time vs. gate resistance**

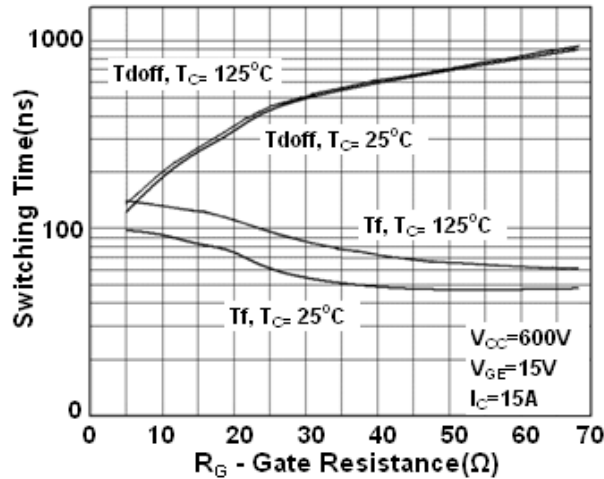

**Switching loss vs. gate resistance**

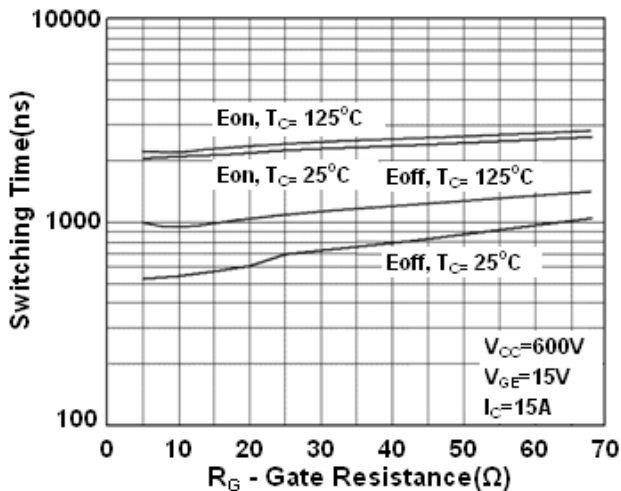

**Turn on time vs. collector current**

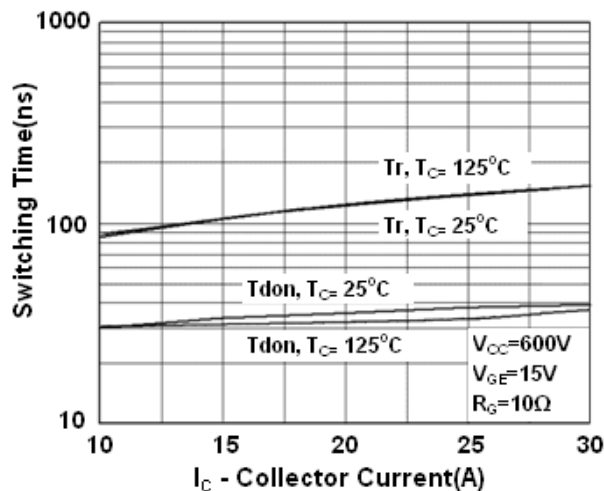

**Turn off time vs. collector current**

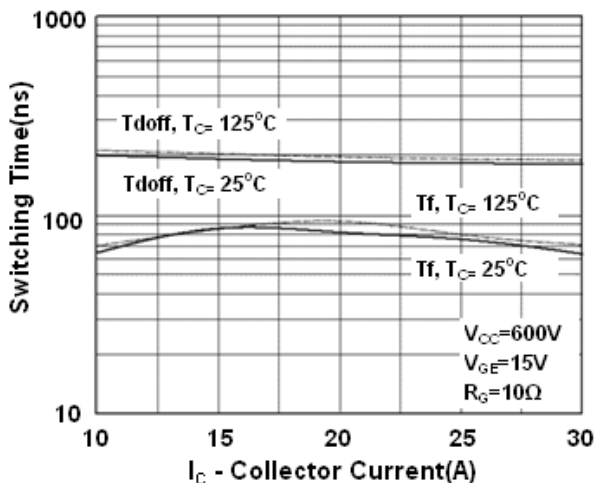

**Switching loss vs. collector current**

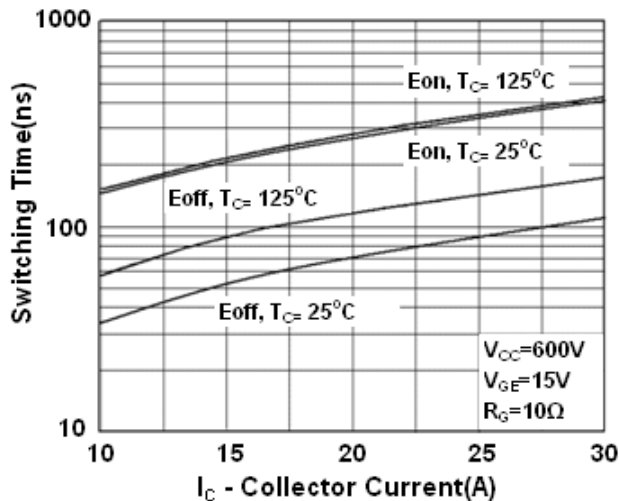

**Electrical Characteristics Curve** ( $T_c = 25^\circ\text{C}$ , unless otherwise noted)

**Gate charge characteristics**

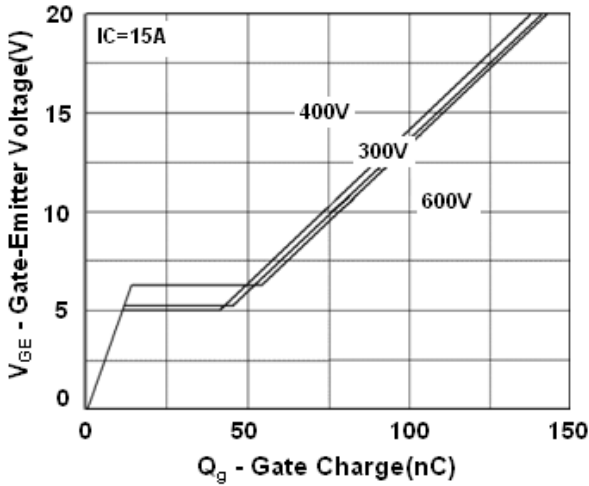

**SOA Characteristics**

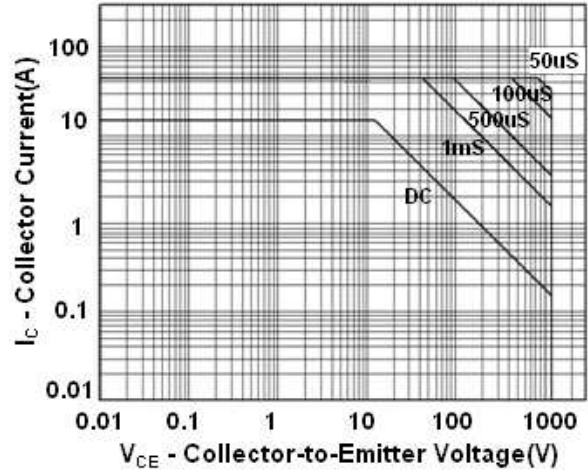

**RBSOA**

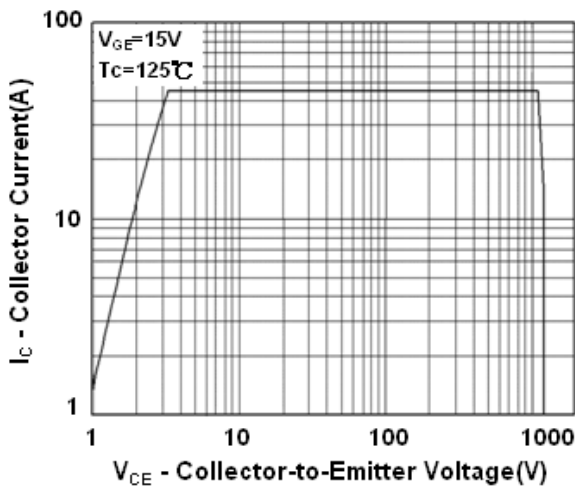

**Conduction characteristics**

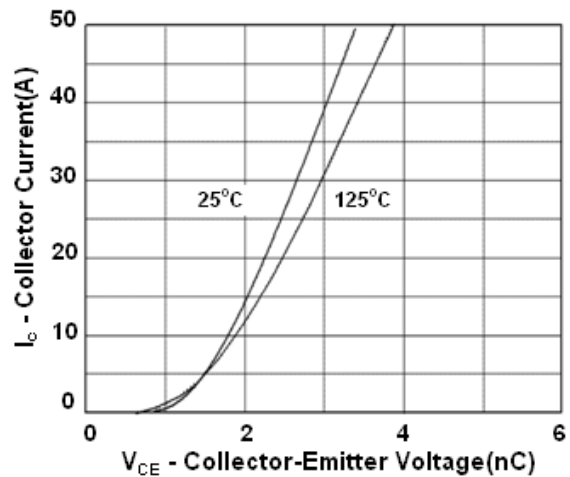

**Reverse recovery current vs. forward current**

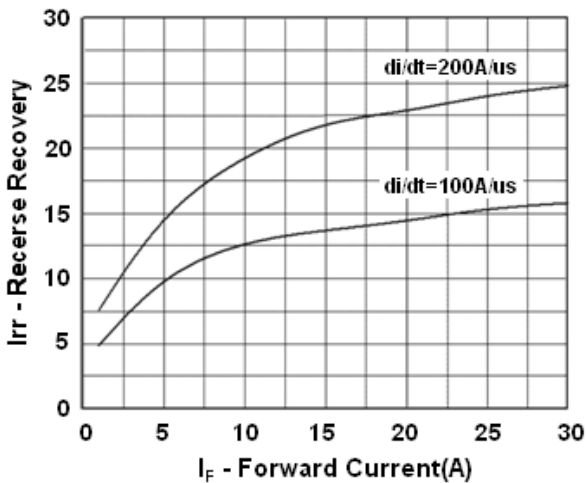

**Stored recovery charge vs. forward current**

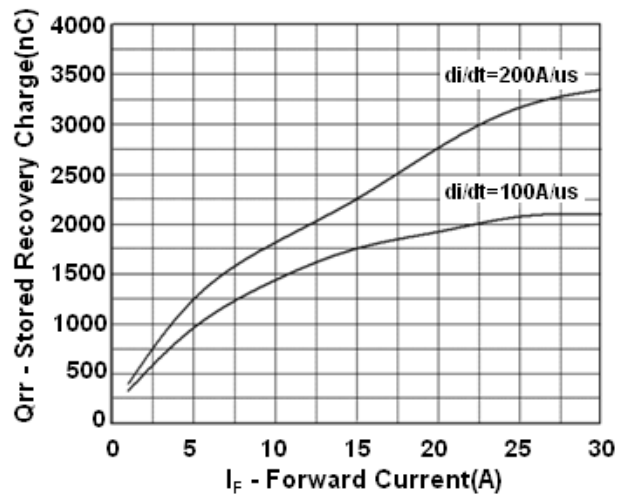

**Electrical Characteristics Curve** ( $T_a = 25^\circ\text{C}$ , unless otherwise noted)

Reverse recovery time vs. forward current

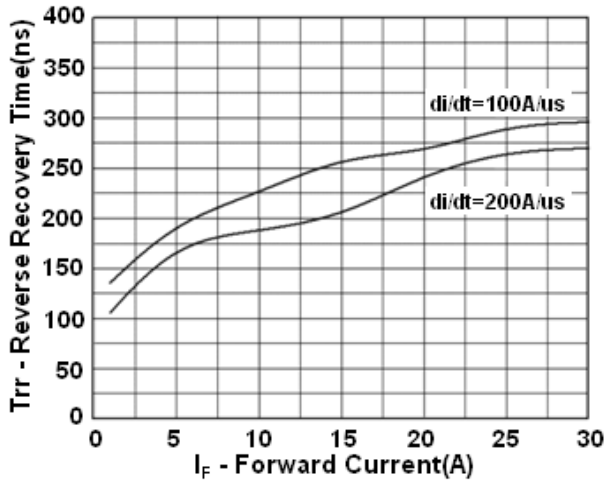

Normalized Thermal Transient Impedance, Junction-to-Ambient

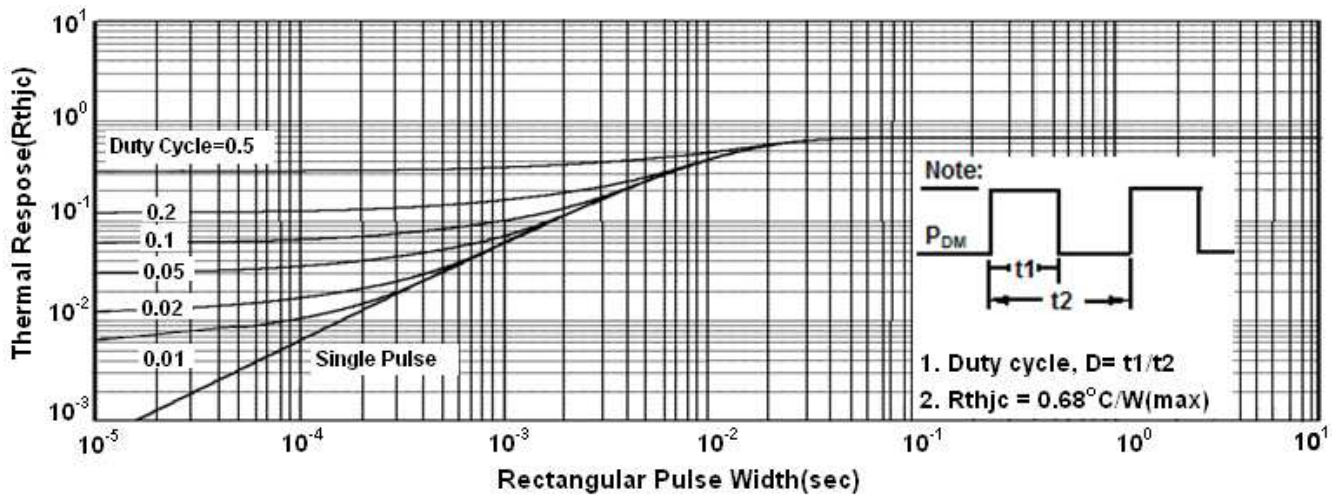

## TO-3PN Mechanical Drawing

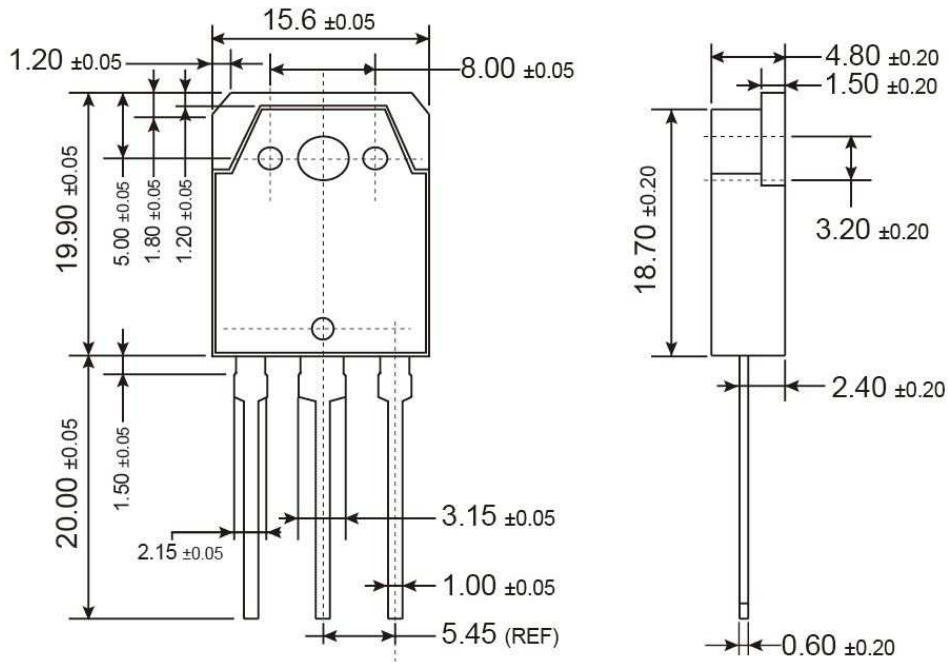

Unit: Millimeters



## Notice

Specifications of the products displayed herein are subject to change without notice. TSC or anyone on its behalf, assumes no responsibility or liability for any errors or inaccuracies.

Information contained herein is intended to provide a product description only. No license, express or implied, to any intellectual property rights is granted by this document. Except as provided in TSC's terms and conditions of sale for such products, TSC assumes no liability whatsoever, and disclaims any express or implied warranty, relating to sale and/or use of TSC products including liability or warranties relating to fitness for a particular purpose, merchantability, or infringement of any patent, copyright, or other intellectual property right.

The products shown herein are not designed for use in medical, life-saving, or life-sustaining applications. Customers using or selling these products for use in such applications do so at their own risk and agree to fully indemnify TSC for any damages resulting from such improper use or sale.