



# TSH343

## 280MHz Single-Supply Triple Video Buffer

- Bandwidth: 280MHz
- 5V single-supply operation
- Internal input DC level shifter
- No input capacitor required
- Internal gain of 6dB for a matching between 3 channels
- Very low harmonic distortion
- Slew rate: 780V/ $\mu$ s
- Specified for 150 $\Omega$  and 100 $\Omega$  loads
- Tested on 5V power supply
- Data min. and max. are tested during production

### Description

The TSH343 is a triple single-supply video buffer featuring an internal gain of 6dB and a large bandwidth of 280MHz.

The main advantage of this circuit is that its input DC level shifter allows for video signals on 75 $\Omega$  video lines without damage to the synchronization tip of the video signal, while using a single 5V power supply with no input capacitor. The DC level shifter is internally fixed and optimized to keep the output video signals between low and high output rails in the best position for the greatest linearity. *Chapter 4* of this datasheet gives technical support when using the TSH343 as Y-Pb-Pr driver for video DAC output on a video line (see TSH344 for RGB signals).

The TSH343 is available in the compact SO8 plastic package for optimum space-saving.

### Order Codes

Part Number	Temperature Range	Package	Packing	Marking
TSH343ID	-40°C to +85°C	SO-8	Tube	TSH343I
TSH343IDT			Tape & Reel	TSH343I

### Pin Connections (top view)

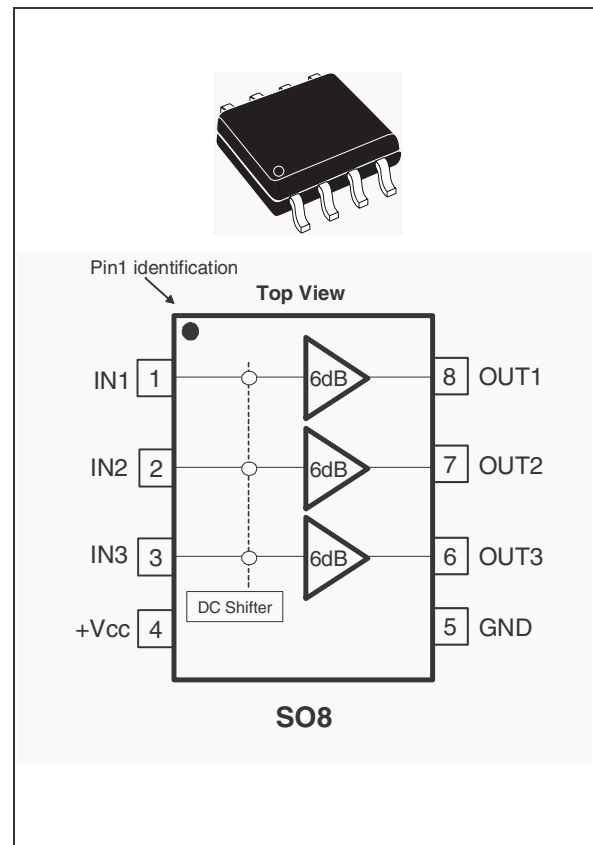

### Applications

- High-end video systems
- High Definition TV (HDTV)
- Broadcast and graphic video
- Multimedia products

# 1 Absolute Maximum Ratings

**Table 1. Key parameters and their absolute maximum ratings**

Symbol	Parameter	Value	Unit
$V_{CC}$	Supply voltage <sup>(1)</sup>	6	V
$V_{in}$	Input Voltage Range <sup>(2)</sup>	0 to +1.4	V
$T_{oper}$	Operating Free Air Temperature Range	-40 to +85	°C
$T_{std}$	Storage Temperature	-65 to +150	°C
$T_j$	Maximum Junction Temperature	150	°C
$R_{thjc}$	SO8 Thermal Resistance Junction to Case	28	°C/W
$R_{thja}$	SO8 Thermal Resistance Junction to Ambient Area	157	°C/W
$P_{max.}$	Maximum Power Dissipation (@ $T_a=25^{\circ}C$ ) for $T_j=150^{\circ}C$	800	mW
ESD	CDM: Charged Device Model	2	kV
	HBM: Human Body Model	1.5	kV
	MM: Machine Model	200	V

1. All voltage values, except differential voltage, are with respect to network terminal.
2. The magnitude of input and output voltage must never exceed  $V_{CC} + 0.3V$ .

**Table 2. Operating conditions**

Symbol	Parameter	Value	Unit
$V_{CC}$	Power Supply Voltage	3 to 5.5 <sup>(1)</sup>	V

1. Tested in full production at 0V/5V single power supply

## 2 Electrical Characteristics

**Table 3.  $V_{CC} = +5V$  Single Supply,  $T_{amb} = 25^{\circ}C$  (unless otherwise specified)**

Symbol	Parameter	Test Condition	Min.	Typ.	Max.	Unit
<b>DC Performance</b>						
$V_{DC}$	Input DC shift	$R_L = 150\Omega$ , $T_{amb}$	0.4	0.6	0.8	mV
		$-40^{\circ}C < T_{amb} < +85^{\circ}C$		0.53		
$I_{ib}$	Input Bias Current	$T_{amb}$ , input to GND		18.2	35	$\mu A$
		$-40^{\circ}C < T_{amb} < +85^{\circ}C$		20.7		
$R_{in}$	Input Resistance	$T_{amb}$		4		$G\Omega$
$C_{in}$	Input Capacitance	$T_{amb}$		1		pF
$I_{CC}$	Supply Current per Buffer	no Load, input to GND		14.4	18	mA
		$-40^{\circ}C < T_{amb} < +85^{\circ}C$		14.9		
PSRR	Power Supply Rejection Ratio $20 \log (\Delta V_{out} / \Delta V_{CC})$ (see <a href="#">Figure 25</a> and <a href="#">Figure 26</a> )	input to GND, $F = 1MHz$ $C_{LF}=470nF$ $C_{HF}=100\mu F$		70		dB
G	DC Voltage Gain	$R_L = 150\Omega$ , $V_{in} = 1V$	1.92	1.99	2.05	V/V
DG	Variation of the DC Voltage Gain between inputs of 0.3V and 1V	Input step from 0.3V to 1V		0.26	0.8	%
$MG_1$	Gain Matching between 3 channels	Input = 1V		0.5	2	%
$MG_{0.3}$	Gain Matching between 3 channels	Input = 0.3V		0.5	2	%
<b>Dynamic Performance and Output Characteristics</b>						
Bw	-3dB Bandwidth	Small Signal $V_{out} = 20mVp$ $R_L = 150\Omega$	160	280		MHz
	Gain Flatness @ 0.1dB	Small Signal $V_{out} = 20mVp$ $R_L = 150\Omega$		65		
FPBW	Full Power Bandwidth	$V_{out} = 2V_{p-p}$ , $V_{ICM} = 0.5V$ , $R_L = 150\Omega$	130	200		MHz
D	Delay between each channel (see <a href="#">Figure 30</a> )	0 to 30MHz		0.5		ns
SR	Slew Rate <sup>(1)</sup>	Input step from 0V to 1V, $R_L = 150\Omega$	500	780		V/ $\mu s$
$V_{OH}$	High Level Output Voltage	$V_{in DC} = +1.5V$ , $R_L = 150\Omega$	3.7	3.9		V
$V_{OL}$	Low Level Output Voltage	$R_L = 150\Omega$		40		mV
$I_{OUT}$	Output Current	$V_{out} = 2V$ , $T_{amb}$	45	90		mA
		$-40^{\circ}C < T_{amb} < +85^{\circ}C$		82		
	Output Short Circuit Current ( $I_{source}$ )			100		mA

Table 3.  $V_{CC} = +5V$  Single Supply,  $T_{amb} = 25^{\circ}C$  (unless otherwise specified)

Symbol	Parameter	Test Condition	Min.	Typ.	Max.	Unit
<b>Noise and Distortion</b>						
eN	Total Input Voltage Noise	$F = 100kHz, R_{IN} = 50\Omega$		29		nV/ $\sqrt{Hz}$
		10kHz to 30MHz 10kHz to 100MHz		158 290		$\mu V_{rms}$
HD2	2nd Harmonic Distortion	$V_{out} = 2V_{p-p}, R_L = 150\Omega$ $F = 10MHz$ $F = 30MHz$		-58 -45		dBc
HD3	3rd Harmonic Distortion	$V_{out} = 2V_{p-p}, R_L = 150\Omega$ $F = 10MHz$ $F = 30MHz$		-72 -50		dBc

1. Non-tested value. Guaranteed value by design.

Figure 1. Frequency response

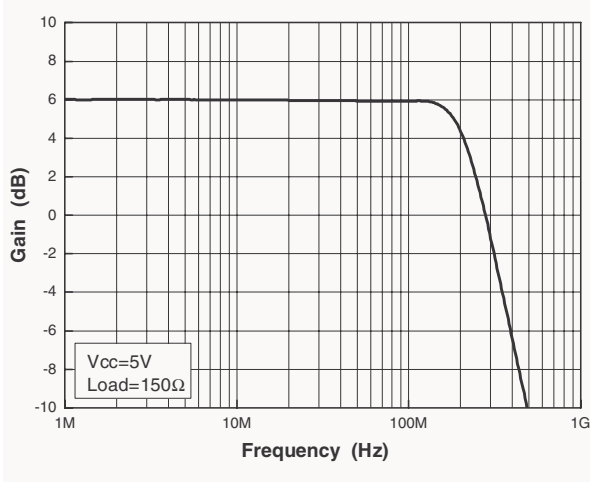

Figure 2. Gain flatness

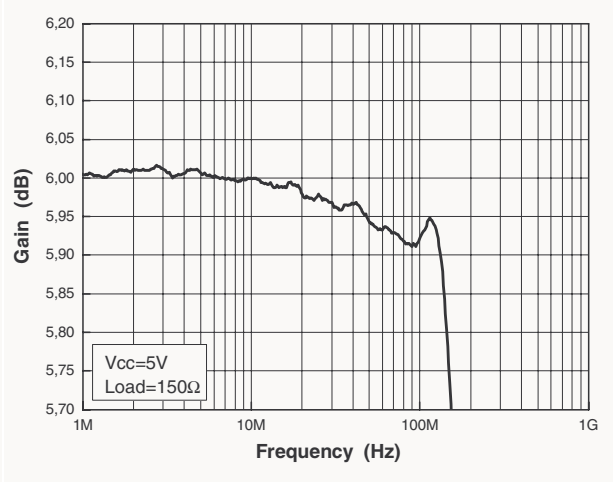

Figure 3. Cross-talk vs. frequency (amp1)

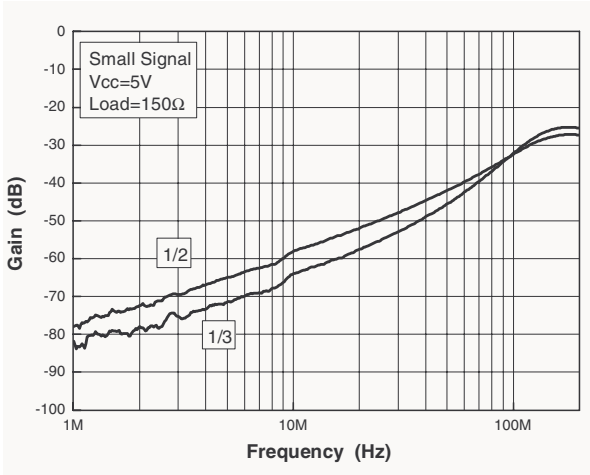

Figure 4. Cross-talk vs. frequency (amp2)

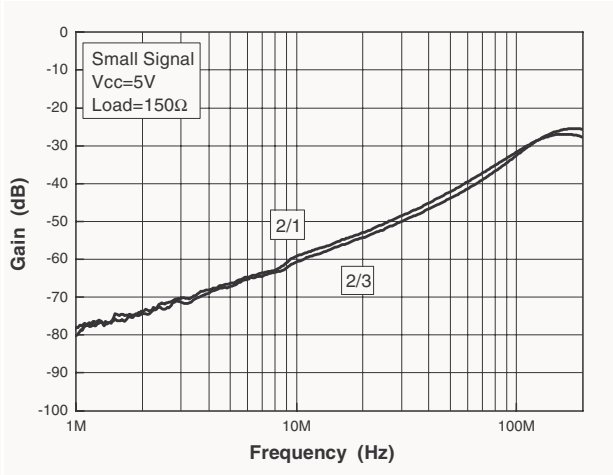

Figure 5. Cross-talk vs. frequency (amp3)

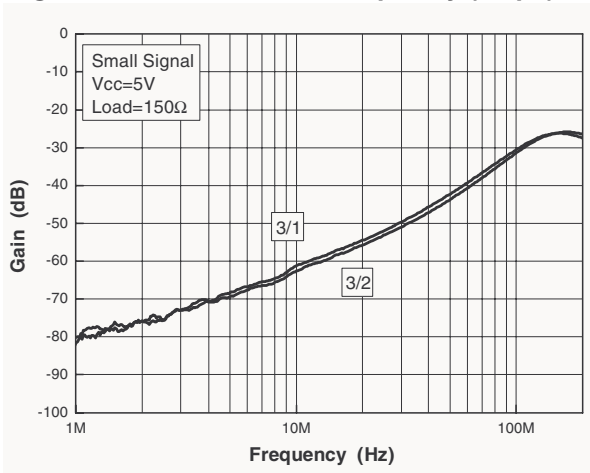

Figure 6. Input noise vs. frequency

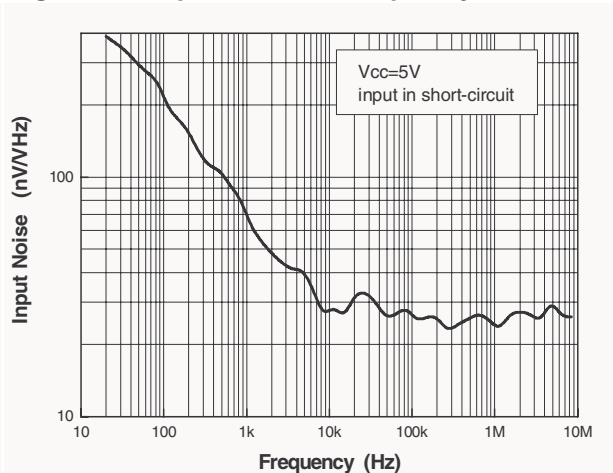

Figure 7. Distortion on 150Ω load - 10MHz

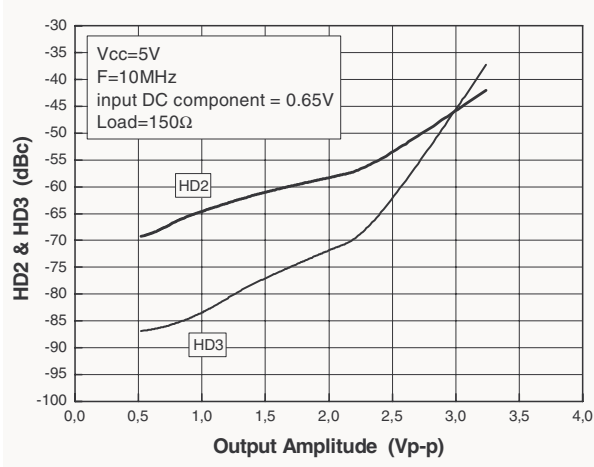

Figure 8. Distortion on 100Ω load - 10MHz

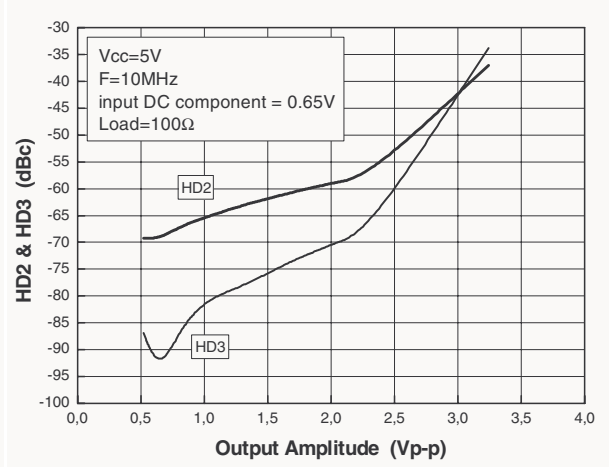

Figure 9. Distortion on 150Ω load - 30MHz

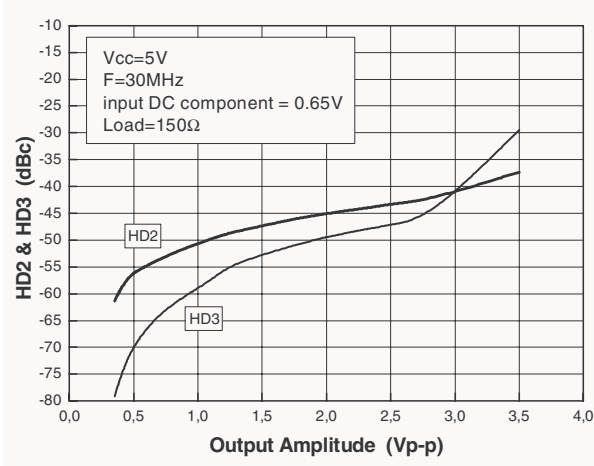

Figure 10. Distortion on 100Ω load - 30MHz

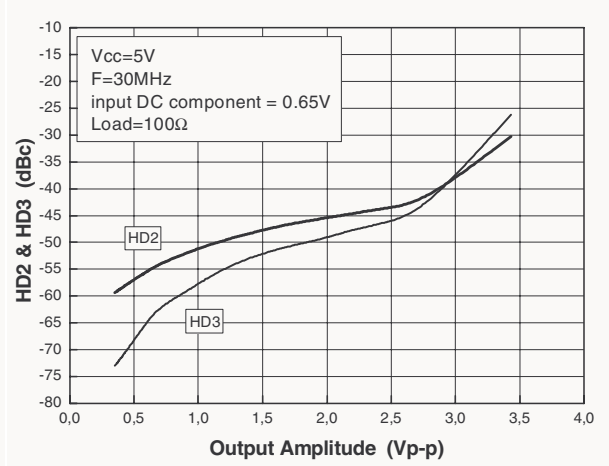

Figure 11. Output DC shift vs. frequency

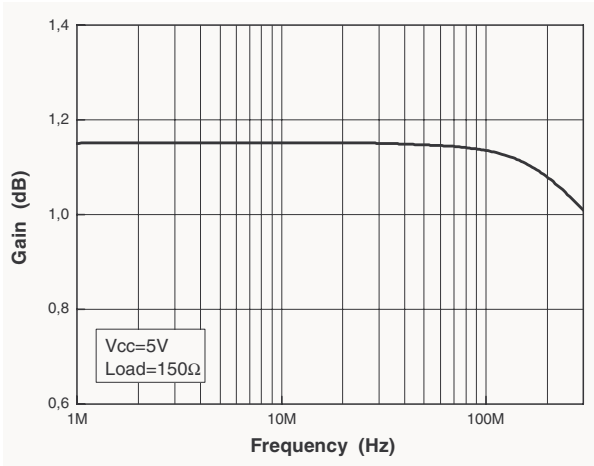

Figure 12. Slew rate

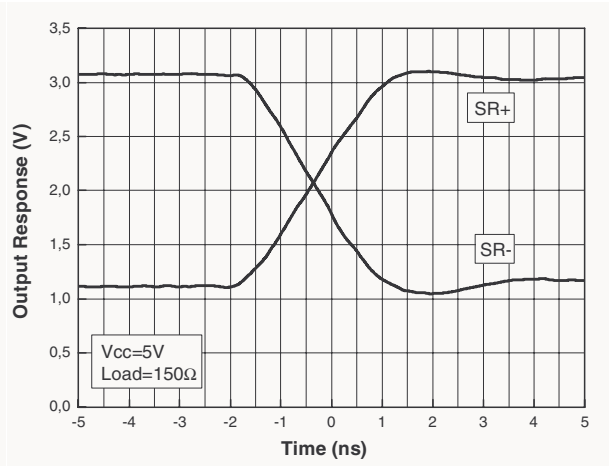

Figure 13. Reverse isolation vs. frequency

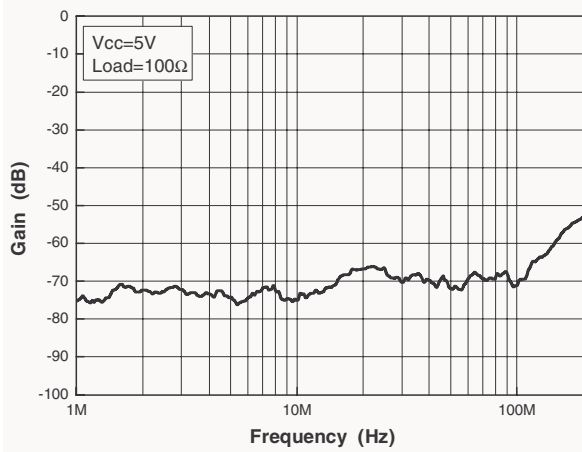

Figure 14. Bandwidth vs. temperature

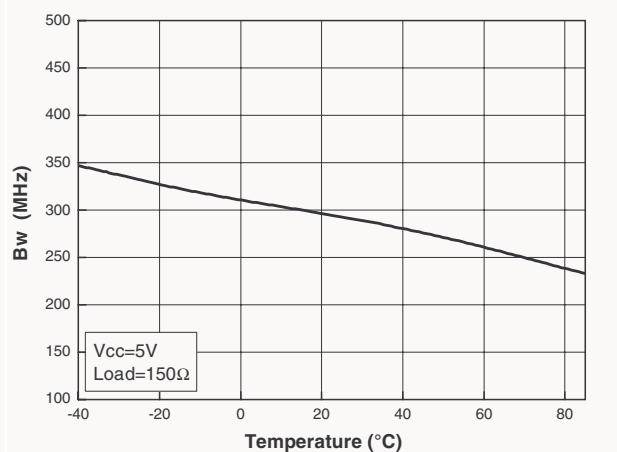

Figure 15. Quiescent current vs. Supply

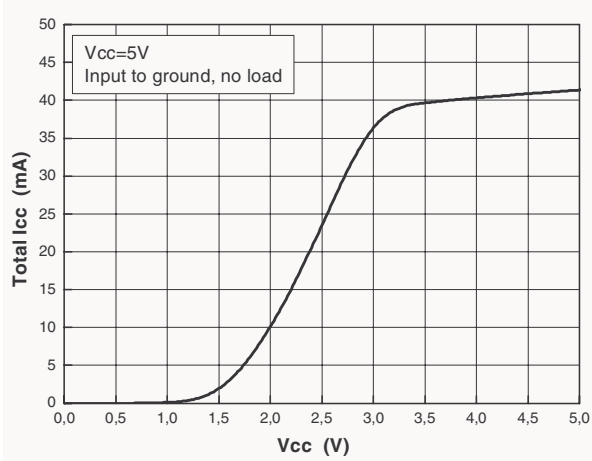

Figure 16. Input DC shift vs. temperature

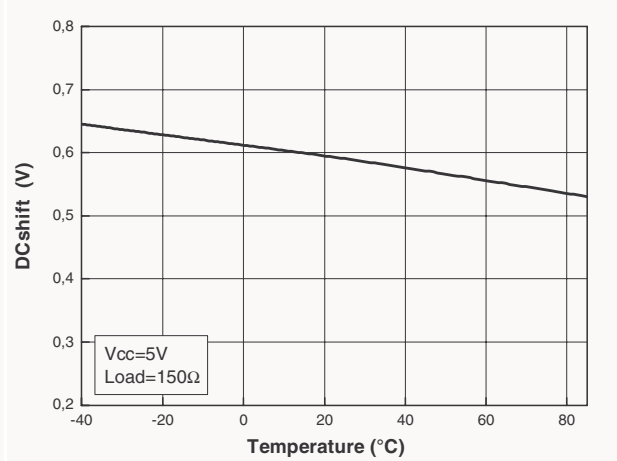

Figure 17. Isource vs. output voltage

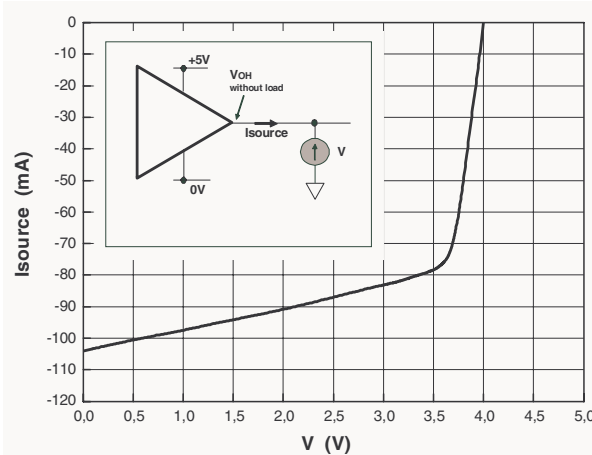

Figure 18. Voltage gain vs. temperature

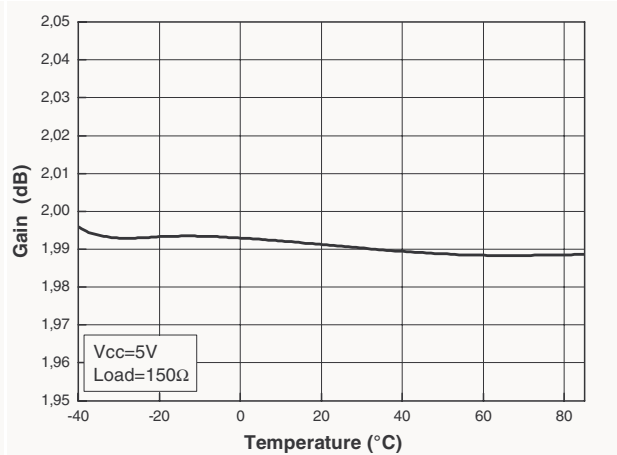

Figure 19. I<sub>BIAS</sub> vs. temperature

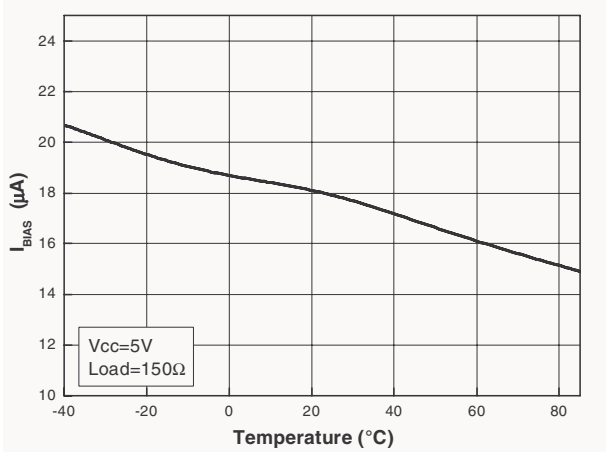

Figure 20. Gain deviation vs. temperature

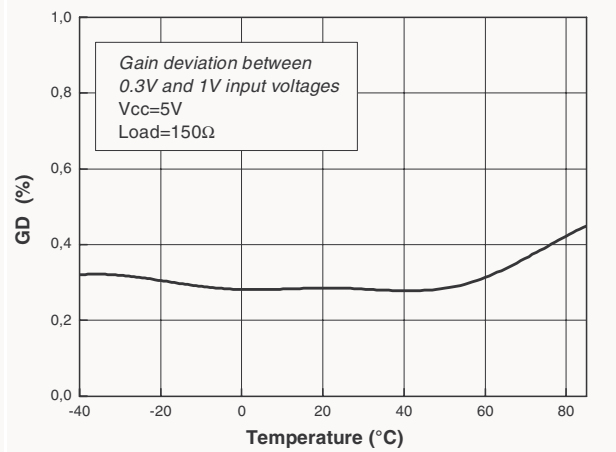

Figure 21. Supply current vs. temperature

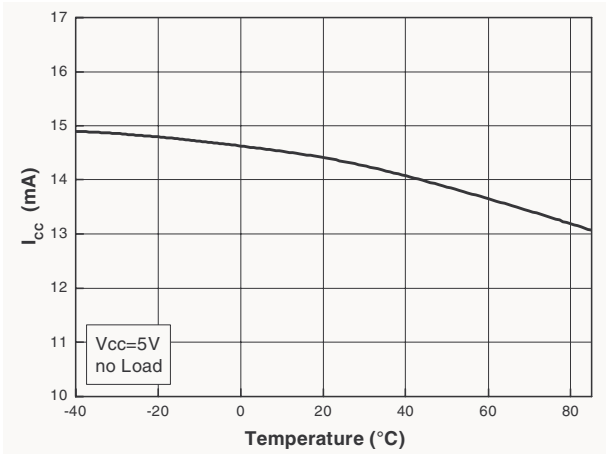

Figure 22. Output current vs. temperature

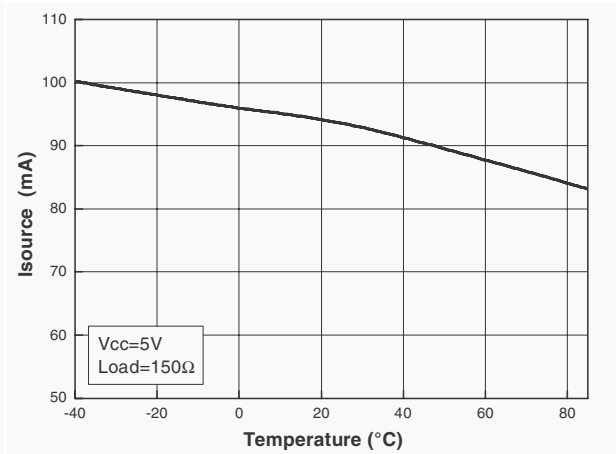

Figure 23. Output higher rail vs. temperature

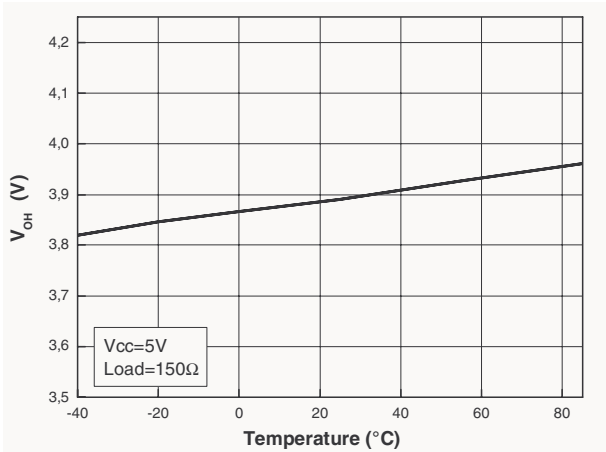
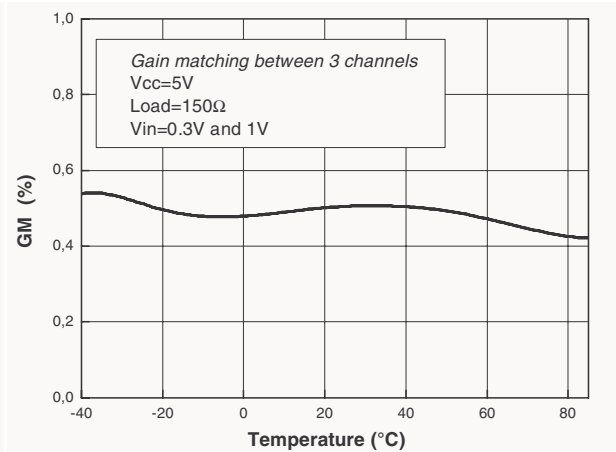

Figure 24. Gain matching vs. temperature





### 3 Power Supply Considerations and improvement of the PSRR

Correct power supply bypassing is very important for optimizing performance in low and high-frequency ranges. Bypass capacitors should be placed as close as possible to the IC pin (pin 4) to improve high-frequency bypassing. A capacitor ( $C_{LF}$ ) greater than 100uF is necessary to improve the PSRR in low frequencies. For better quality bypassing, a capacitor of 470nF ( $C_{HF}$ ) is added using the same implementation conditions to improve the PSRR in the higher frequencies.

**Figure 25. Circuit for power supply bypassing**

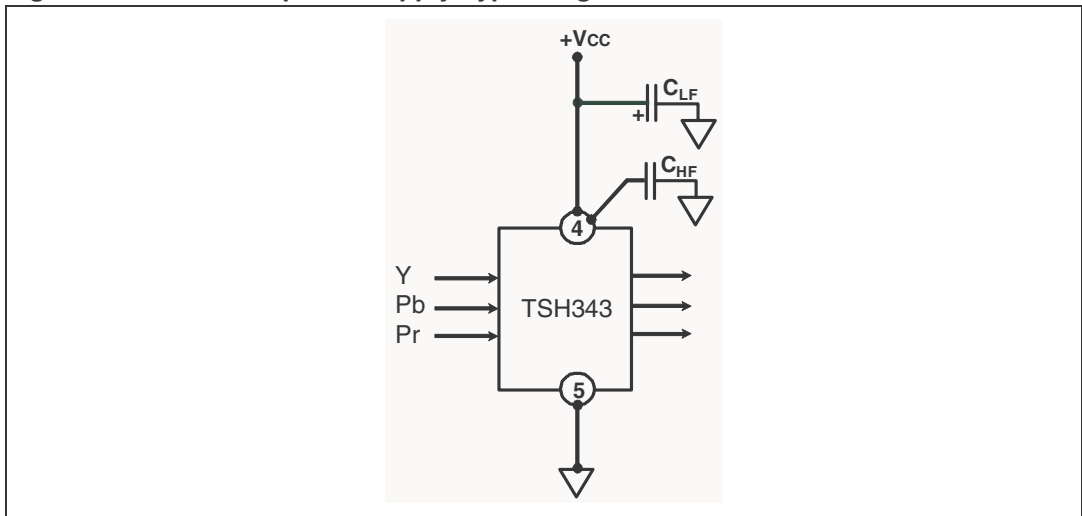

The following graph in *Figure 26* shows the evolution of the PSRR against the frequency when the power supply decoupling is achieved carefully or not.

**Figure 26. PSRR improvement**

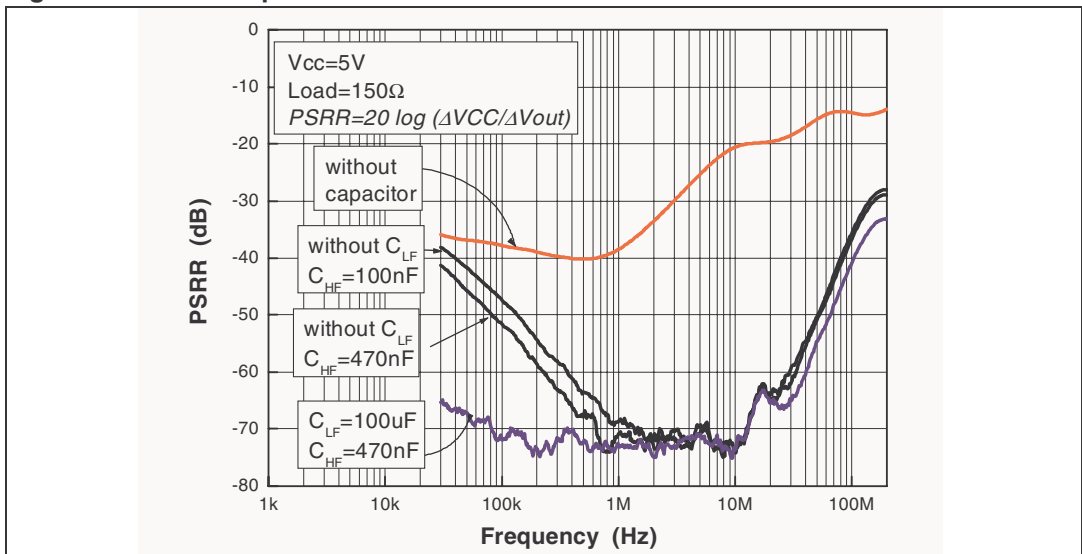

# 4 Using the TSH343 to Drive Y-Pb-Pr Video Components

Figure 27. Shapes of video signals coming from DACs

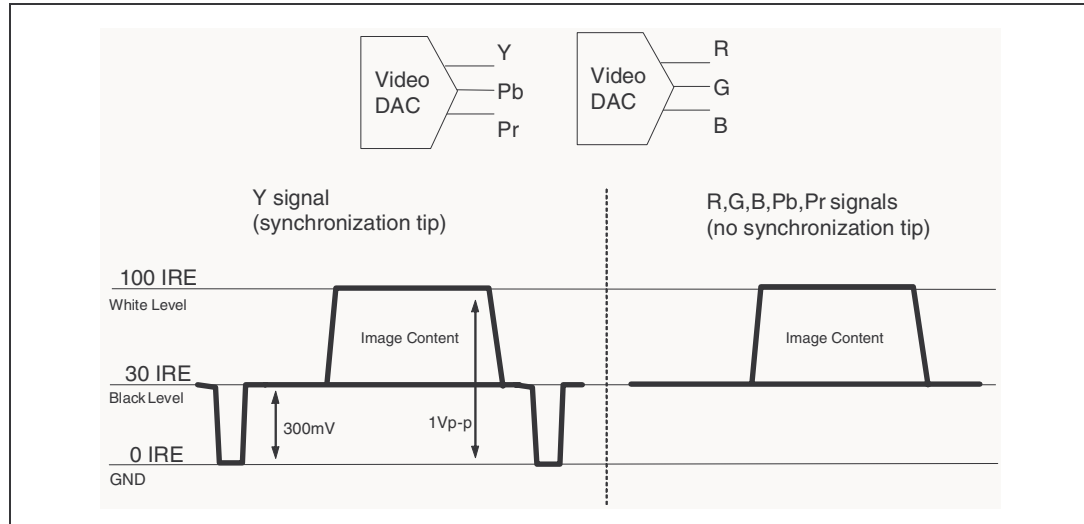

Figure 28. Implementation of the video driver on output video DACs

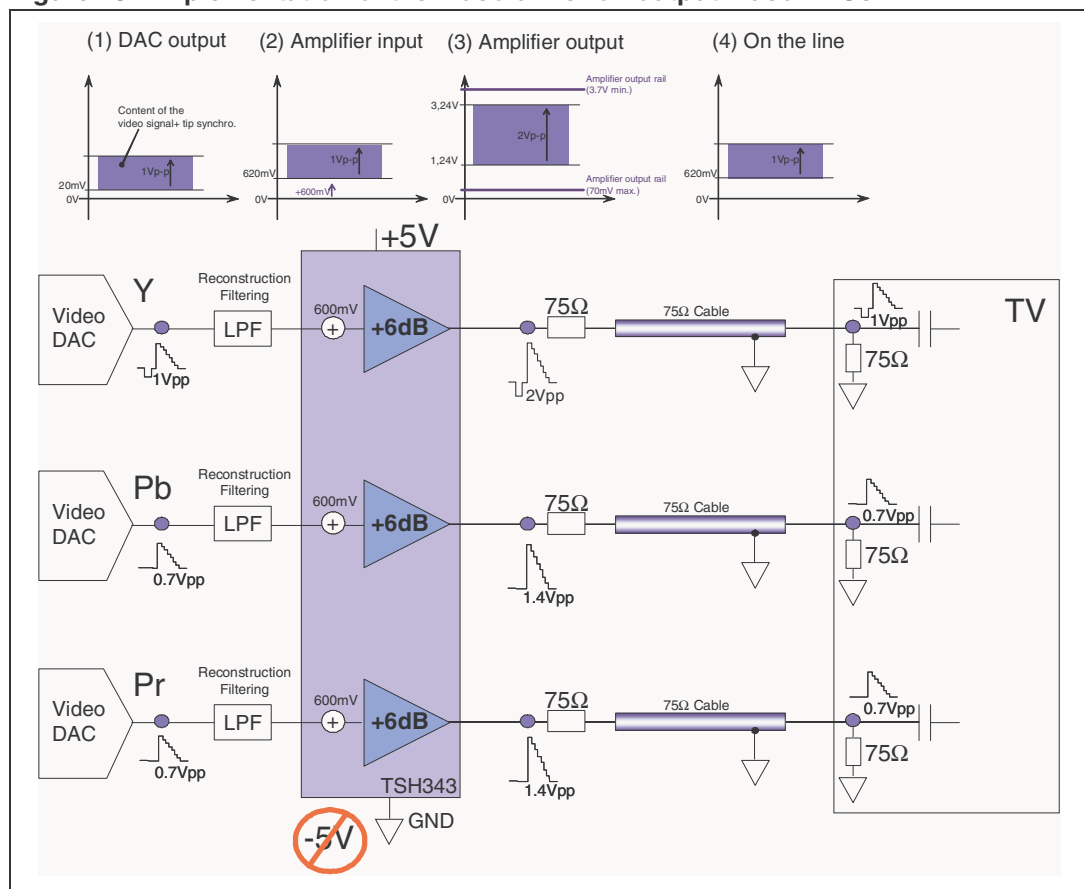

Figure 28 shows a schematic diagram of the use of the TSH343 to drive video output from DACs.

The TSH343 is used to drive high definition video signals up to 30MHz on 75-ohm video lines. It is dedicated to driving YPbPr signals where the synchronization tip—close to zero volts—is included in Y signal, as seen in (1). An internal input DC value of 600mV is added to the video signal in order to shift the bottom from 0V to 600mV as seen in (2).

The shift is not based on the average of the signal, but is an analog summation of a DC component to the video signal. Therefore, no input capacitors are required which provides a real advantage in terms of cost and board space.

Under these conditions, it is possible to drive the signal in single supply without any saturation of the driver against the lower rail.

Assuming that we lose half of the signal by output impedance-matching in order to properly drive the video line, the shifted signal is multiplied by a gain of 2 or +6dB (3).

## 4.1 Delay between channels

Figure 29. Measurement of the delay between each channel

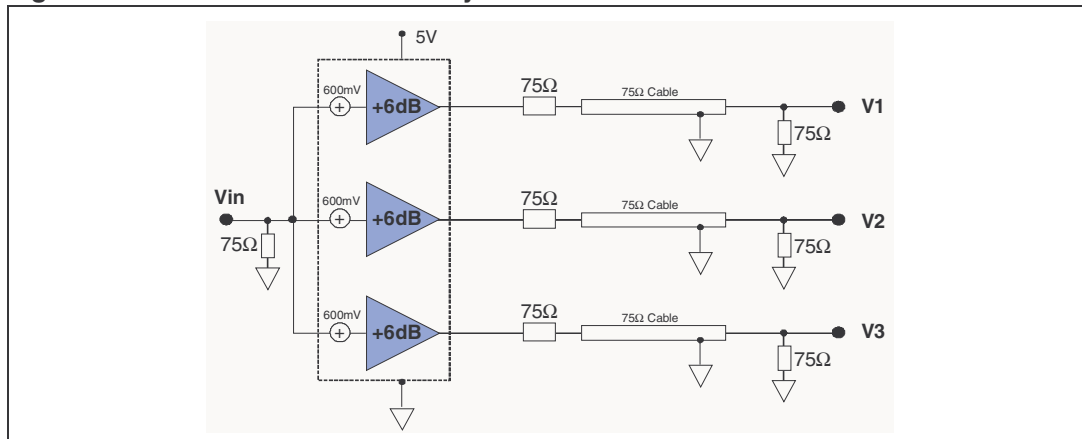

Delay between each video component is an important aspect in high definition video systems. To drive properly the three video components without any relative delay, the dice of the TSH343 is layout out with a very symmetrical geometry. The effect is direct on the synchronization of each channel, as shown in Figure 30. No delay appears between each channel when the same  $V_{in}$  signal is applied on the three inputs. Note that the delay from the inputs the outputs equals 4ns.

Figure 30. Relative delay between each channel

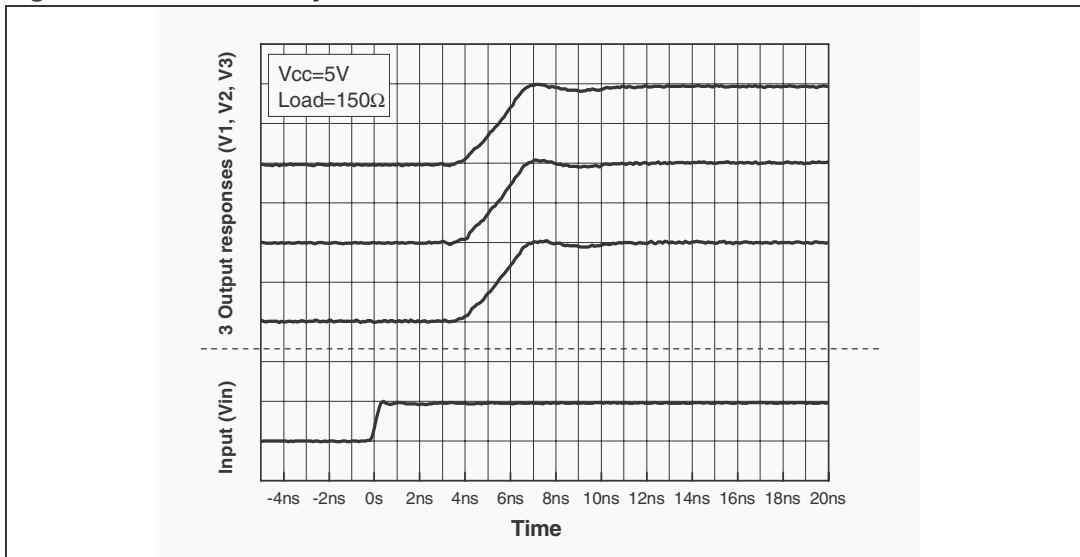

## 5 Package Mechanical Data

### SO-8 MECHANICAL DATA

DIM.	mm.			inch		
	MIN.	TYP.	MAX.	MIN.	TYP.	MAX.
A	1.35		1.75	0.053		0.069
A1	0.10		0.25	0.04		0.010
A2	1.10		1.65	0.043		0.065
B	0.33		0.51	0.013		0.020
C	0.19		0.25	0.007		0.010
D	4.80		5.00	0.189		0.197
E	3.80		4.00	0.150		0.157
e		1.27			0.050	
H	5.80		6.20	0.228		0.244
h	0.25		0.50	0.010		0.020
L	0.40		1.27	0.016		0.050
k	$\delta'$ (max.)					
ddd			0.1			0.04

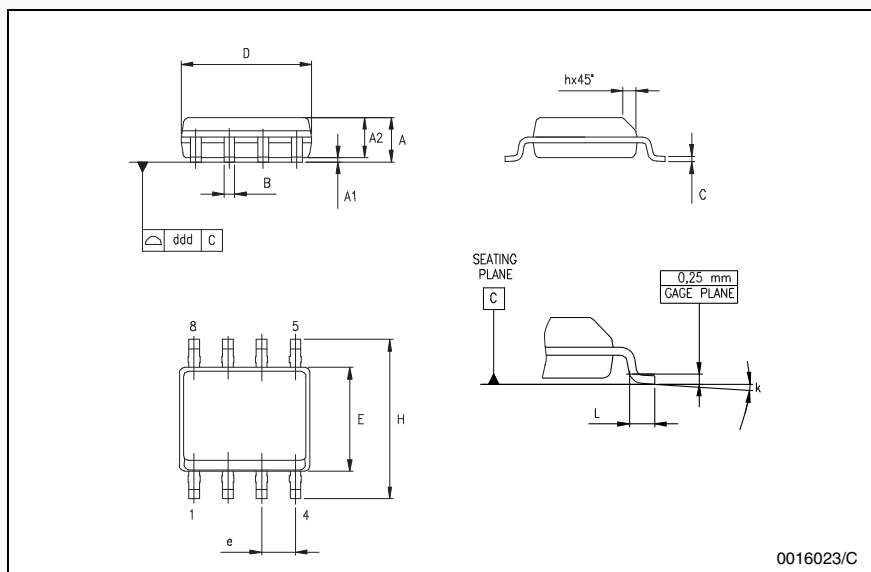

## 6 Revision History

**Table 4. Document revision history**

Date	Revision	Description of Changes
Dec. 2005	1	First release of datasheet.
Jan. 2006	2	Capa-load option paragraph deleted in page 11.

Information furnished is believed to be accurate and reliable. However, STMicroelectronics assumes no responsibility for the consequences of use of such information nor for any infringement of patents or other rights of third parties which may result from its use. No license is granted by implication or otherwise under any patent or patent rights of STMicroelectronics. Specifications mentioned in this publication are subject to change without notice. This publication supersedes and replaces all information previously supplied. STMicroelectronics products are not authorized for use as critical components in life support devices or systems without express written approval of STMicroelectronics.

The ST logo is a registered trademark of STMicroelectronics.  
All other names are the property of their respective owners

© 2006 STMicroelectronics - All rights reserved

STMicroelectronics group of companies

Australia - Belgium - Brazil - Canada - China - Czech Republic - Finland - France - Germany - Hong Kong - India - Israel - Italy - Japan - Malaysia - Malta - Morocco - Singapore - Spain - Sweden - Switzerland - United Kingdom - United States of America

[www.st.com](http://www.st.com)