

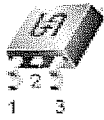

# TSM2N60

## N-Channel Power Enhancement Mode MOSFET

TO-252



TO-251

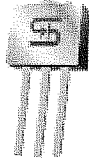

Pin assignment:

1. Gate
2. Source
3. Drain

$V_{DS} = 600V$

$I_D = 2A$

$R_{DS(on)}, V_{GS} @ 10V, I_{DS} @ 1.0A = 4.4\Omega$

### General Description

The TSM2N60 is used an advanced termination scheme to provide enhanced voltage-blocking capability without degrading performance over time. In addition, this advanced MOSFET is designed to withstand high energy in avalanche and commutation modes. The new energy efficient design also offers a drain- to-source diode with a fast recovery time. Designed for high voltage, high speed switching applications in power supplies, converters and PWM motor controls, these devices are particularly well suited for bridge circuits where diode speed and commutating safe operating areas are critical and offer additional and safety margin against unexpected voltage transients.

### Features

- ◇ Robust high voltage termination
- ◇ Avalanche energy specified
- ◇ Diode is characterized for use in bridge circuits
- ◇ Source to Drain diode recovery time comparable to a discrete fast recovery diode.
- ◇  $I_{DSS}$  and  $V_{DS(on)}$  specified at elevated temperature

### Block Diagram

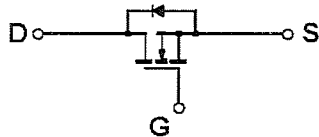

### Ordering Information

Part No.	Packing	Package
TSM2N60CP	Tape & Reel	TO-252
TSM2N60CH	Tube	TO-251

### Absolute Maximum Rating (Ta = 25 °C unless otherwise noted)

Parameter	Symbol	Limit	Unit
Drain-Source Voltage	$V_{DS}$	600V	V
Gate-Source Voltage	$V_{GS}$	± 20	V
Continuous Drain Current	$I_D$	2	A
Pulsed Drain Current	$I_{DM}$	9	A
Maximum Power Dissipation	$P_D$	Ta = 25 °C	50
		Ta > 25 °C	0.4
Operating Junction Temperature	$T_J$	+150	°C
Operating Junction and Storage Temperature Range	$T_J, T_{STG}$	- 55 to +150	°C
Single Pulse Drain to Source Avalanche Energy ( $V_{DD} = 100V, V_{GS} = 10V, I_{AS} = 2A, L = 10mH, R_G = 25\Omega$ )	$E_{AS}$	20	mJ

### Thermal Performance

Parameter	Symbol	Limit	Unit
Lead Temperature (1/8" from case)	$T_L$	10	S
Junction to Ambient Thermal Resistance (PCB mounted)	$R_{\theta ja}$	62.5	°C/W

Note: Surface mounted on FR4 board  $t \leq 10$ sec.



Electrical Characteristics						
T <sub>j</sub> = 25 °C, unless otherwise noted						
Parameter	Conditions	Symbol	Min	Typ	Max	Unit
<b>Static</b>						
Drain-Source Breakdown Voltage	V <sub>GS</sub> = 0V, I <sub>D</sub> = 250uA	BV <sub>DSS</sub>	600	--	--	V
Drain-Source On-State Resistance	V <sub>GS</sub> = 10V, I <sub>D</sub> = 0.6A	R <sub>DS(ON)</sub>	--	--	8.0	Ω
Gate Threshold Voltage	V <sub>DS</sub> = V <sub>GS</sub> , I <sub>D</sub> = 250uA	V <sub>GS(TH)</sub>	2.0	--	4.0	V
Zero Gate Voltage Drain Current	V <sub>DS</sub> = 600V, V <sub>GS</sub> = 0V	I <sub>DSS</sub>	--	--	250	uA
Gate Body Leakage	V <sub>GS</sub> = ± 20V, V <sub>DS</sub> = 0V	I <sub>GSS</sub>	--	--	± 100	nA
Forward Transconductance	V <sub>DS</sub> ≥ 50V, I <sub>D</sub> = 1.0A	g <sub>fs</sub>	1.0	--	--	S
<b>Dynamic</b>						
Total Gate Charge	V <sub>DS</sub> = 400V, I <sub>D</sub> = 2.0A, V <sub>GS</sub> = 10V	Q <sub>g</sub>	--	13	22	nC
Gate-Source Charge		Q <sub>gs</sub>	--	2	--	
Gate-Drain Charge		Q <sub>gd</sub>	--	6	--	
Turn-On Delay Time	V <sub>DD</sub> = 300V, I <sub>D</sub> = 2A, V <sub>GEN</sub> = 10V, R <sub>G</sub> = 18Ω	t <sub>d(on)</sub>	--	12		nS
Turn-On Rise Time		t <sub>r</sub>	--	21		
Turn-Off Delay Time		t <sub>d(off)</sub>	--	30		
Turn-Off Fall Time		t <sub>f</sub>	--	24		
Input Capacitance	V <sub>DS</sub> = 25V, V <sub>GS</sub> = 0V, f = 1.0MHz	C <sub>iss</sub>	--	435	--	pF
Output Capacitance		C <sub>oss</sub>	--	56	--	
Reverse Transfer Capacitance		C <sub>rss</sub>	--	9.2	--	
<b>Source-Drain Diode</b>						
Max. Diode Forward Current		I <sub>S</sub>	--	--	2.0	A
Diode Forward Voltage	I <sub>S</sub> = 2.0A, V <sub>GS</sub> = 0V	V <sub>SD</sub>	--	--	1.6	V

Note: 1. pulse test: pulse width ≤ 300uS, duty cycle ≤ 2%  
 2. Negligible, Dominated by circuit inductance.

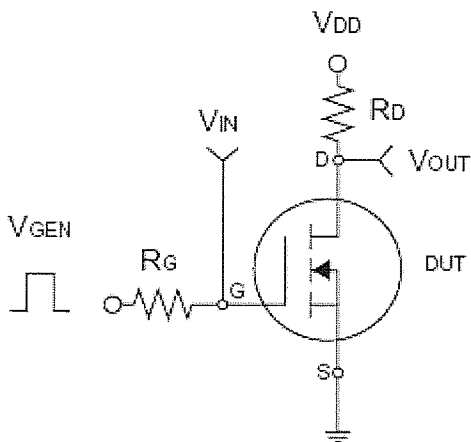

Switching Test Circuit

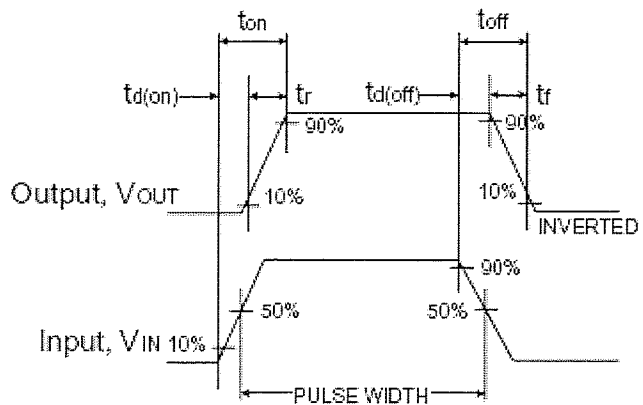

Switchin Waveforms

### TO-252 Mechanical Drawing

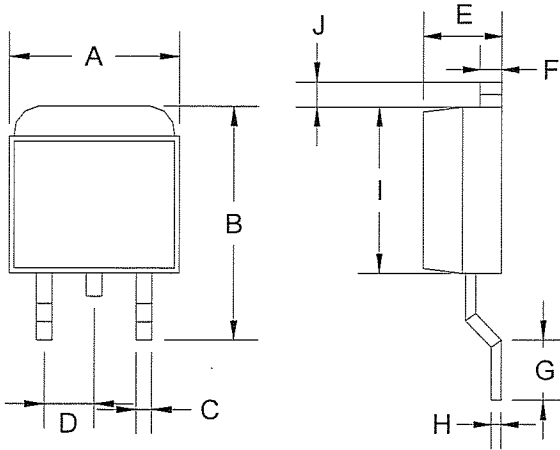

TO-252 DIMENSION				
DIM	MILLIMETERS		INCHES	
	MIN	MAX	MIN	MAX
A	6.570	6.840	0.259	0.269
B	9.250	10.400	0.364	0.409
C	0.550	0.700	0.022	0.028
D	2.560	2.670	0.101	0.105
E	2.300	2.390	0.090	0.094
F	0.490	0.570	0.019	0.022
G	1.460	1.580	0.057	0.062
H	0.520	0.570	0.020	0.022
I	5.340	5.550	0.210	0.219
J	1.460	1.640	0.057	0.065

### TO-252 Mechanical Drawing

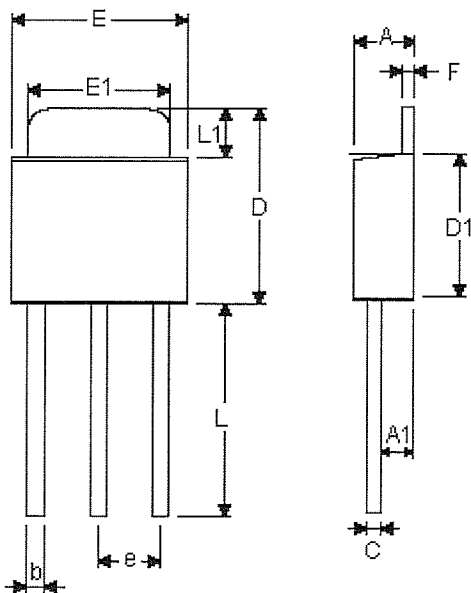

TO-252 DIMENSION				
DIM	MILLIMETERS		INCHES	
	MIN	MAX	MIN	MAX
A	2.20	2.4	0.087	0.095
A1	1.10	1.30	0.043	0.051
b	0.40	0.80	0.016	0.032
C	0.40	0.60	0.016	0.024
D	6.70	7.30	0.264	0.287
D1	5.40	5.65	0.213	0.222
E	6.40	6.65	0.252	0.262
e	2.10	2.50	0.083	0.098
F	0.40	0.60	0.016	0.024
L	7.00	8.00	0.276	0.315
L1	1.60	1.86	0.063	0.073