

## Single P-Channel 1.8V Specified MicroSURF™ MOSFET

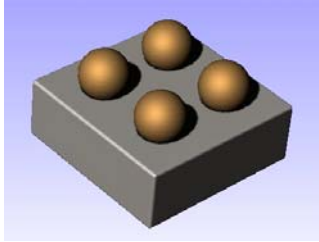

Patent Pending

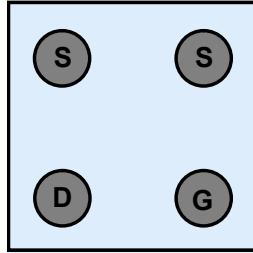

Bump Side View

### Lateral Power™ for Load Switching and PA Switch

$V_{DS} = -12V$

$R_{DS(on)}, V_{GS} @ -4.5V, I_{DS} @ -4.9A = 55m\Omega$

$R_{DS(on)}, V_{GS} @ -2.5V, I_{DS} @ -4.4A = 70m\Omega$

$R_{DS(on)}, V_{GS} @ -1.8V, I_{DS} @ -4.0A = 90m\Omega$

### Description

TSM4405P is new low cost, state of the art MicroSURF™ lateral MOSFET process technology in chip scale bondwireless packaging minimizes PCB space and  $R_{ds(on)}$  plus provides an ultra low  $Q_g \times R_{ds(on)}$  figure of merit.

### Features

- ✧ Low profile package: less than 0.8mm height when mounted on PCB
- ✧ Occupies only 1.21mm<sup>2</sup> of PCB area
- ✧ Less than 30% of the area of a SC-70
- ✧ Excellent thermal and electrical capabilities
- ✧ Lead free solder bumps available

### Block Diagram

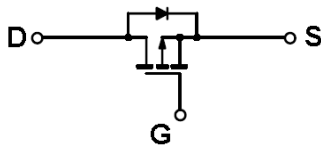

### Ordering Information

Part No.	Packing	Q'ty
TSM4405P	Tape & Reel	3kpcs / 7"

### Absolute Maximum Rating (Ta = 25°C unless otherwise noted)

Parameter	Symbol	Limit	Unit
Drain-Source Voltage	$V_{DS}$	-12V	V
Gate-Source Voltage	$V_{GS}$	±8	V
Continuous Drain Current	$I_D$	-4.9	A
Pulsed Drain Current	$I_{DM}$	-10	A
Maximum Power Dissipation (Steady State)	$P_D$	1.5	W
Operating Junction Temperature	$T_J$	+150	°C
Operating Junction and Storage Temperature Range	$T_J, T_{STG}$	-55 to +150	°C

### Thermal Performance

Parameter	Symbol	Limit	Unit
Junction to Ambient Thermal Resistance	$R_{\theta ja}$	85	°C/W
Junction to Balls Thermal Resistance	$R_{\theta jR}$	20	°C/W

Electrical Characteristics						
Ta = 25 °C, unless otherwise noted						
Parameter	Conditions	Symbol	Min	Typ	Max	Unit
<b>Static</b>						
Drain-Source Breakdown Voltage	$V_{GS} = 0V, I_D = -250\mu A$	$BV_{DSS}$	--	--	-12	V
Drain-Source On-State Resistance	$V_{GS} = -4.5V, I_D = -1.0A$	$R_{DS(ON)}$	--	--	55	mΩ
	$V_{GS} = -2.5V, I_D = -1.0A$		--	--	70	
	$V_{GS} = -1.8V, I_D = -1.0A$		--	--	90	
Gate Threshold Voltage	$V_{DS} = V_{GS}, I_D = -250\mu A$	$V_{GS(TH)}$	--	-0.7	--	V
Zero Gate Voltage Drain Current	$V_{DS} = -12V, V_{GS} = 0V$	$I_{DSS}$	--	--	-1.0	uA
	$T_a = 25^\circ C$		--	--	-5.0	
Gate Body Leakage	$V_{GS} = \pm 8V, V_{DS} = 0V$	$I_{GSS}$	--	--	$\pm 100$	nA
<b>Dynamic</b>						
Total Gate Charge	$V_{DS} = -6V, I_D = -1.0A, V_{GS} = -4.5V$	$Q_g$	--	9.0	--	nC
Input Capacitance	$V_{DS} = -12V, V_{GS} = 0V, f = 1.0MHz$	$C_{iss}$	--	800	--	pF
Output Capacitance		$C_{oss}$	--	250	--	
Reverse Transfer Capacitance		$C_{rss}$	--	100	--	
<b>Source-Drain Diode</b>						
Max. Diode Forward Current		$I_S$	--	--	-1.0	A
Diode Forward Voltage	$I_S = -1.0A, V_{GS} = 0V$	$V_{SD}$	--	-0.7.1	-1.2	V
Source-Drain Reverse Recovery Time	$I_S = -1.0A, V_{GS} = 0V, di / dt = 100A / \mu S$	$T_{rr}$	--	40	--	nS

Note : pulse test: pulse width  $\leq 300\mu S$ , duty cycle  $\leq 2\%$

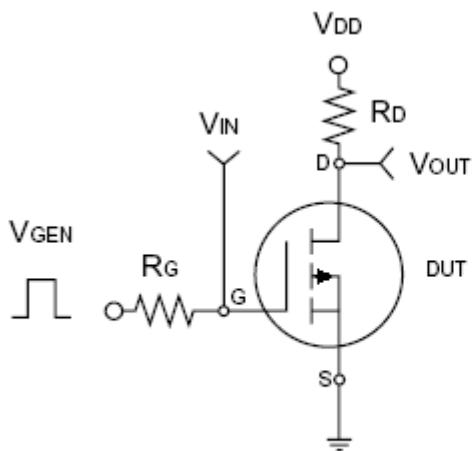

Switching Test Circuit

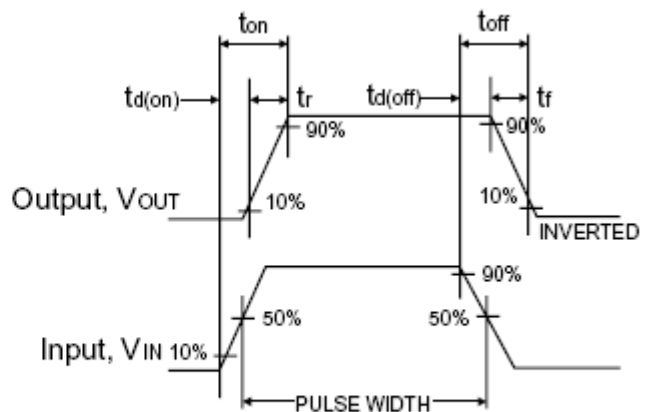

Switchin Waveforms

**Typical Characteristics Curve** (Ta = 25 °C unless otherwise noted)

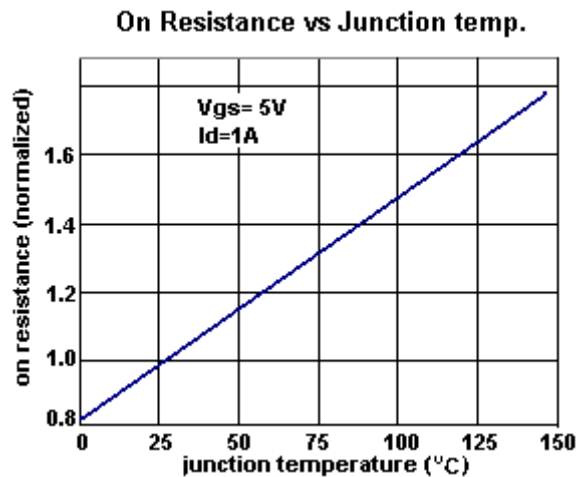
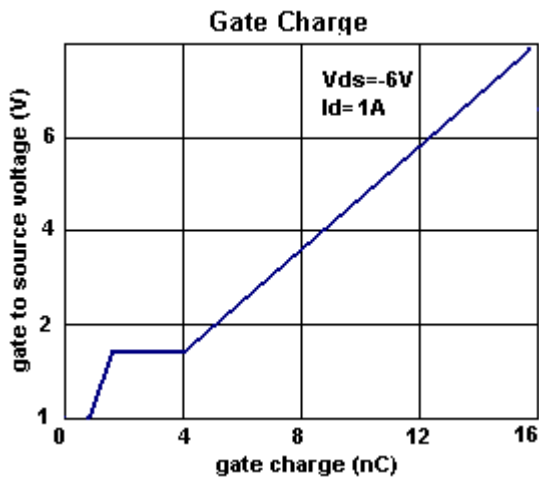
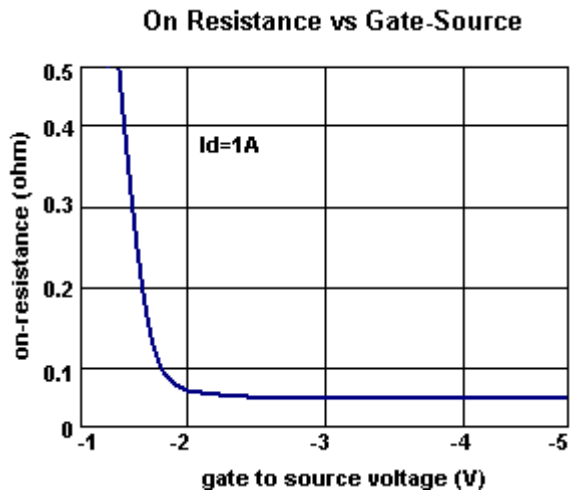
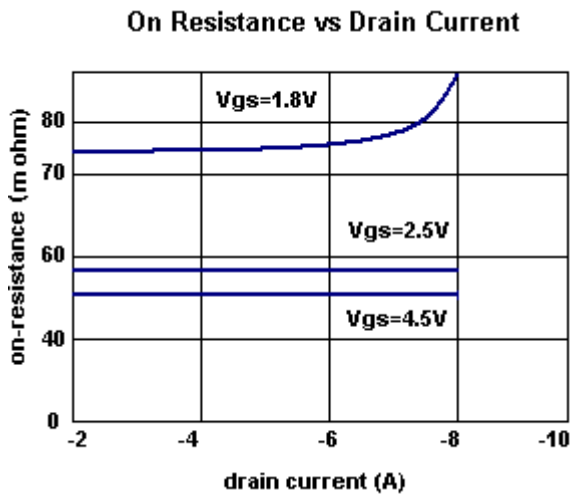
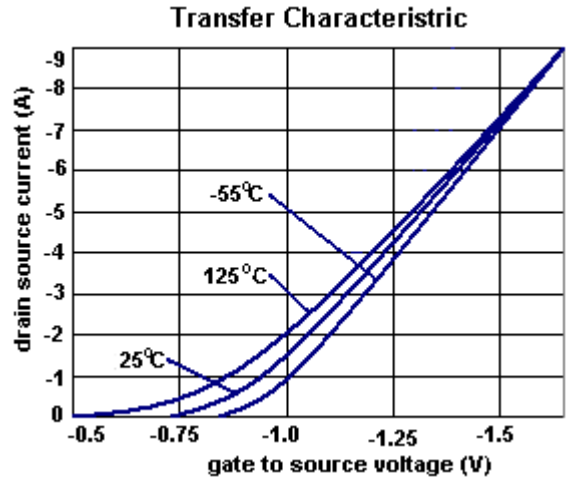
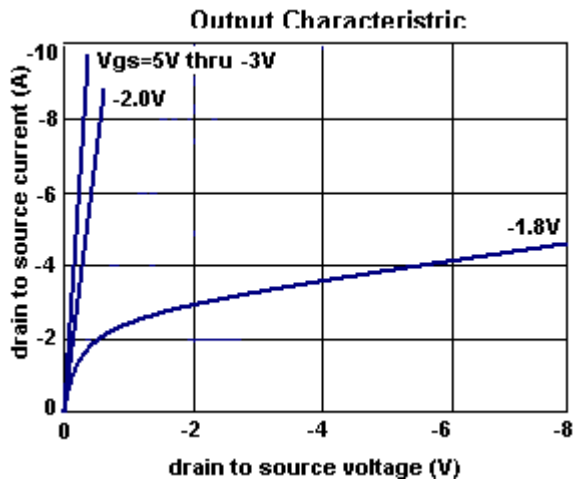

**Typical Characteristics Curve** (Ta = 25 °C unless otherwise noted)

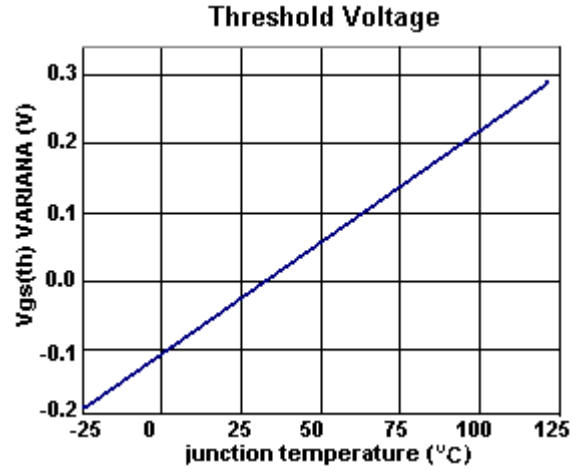
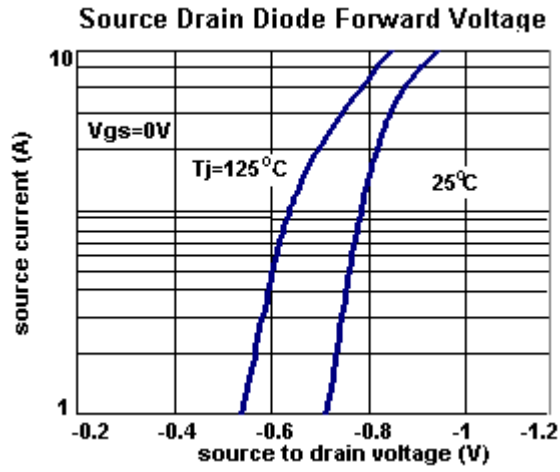

### Dimensional Outline and Pad Layout

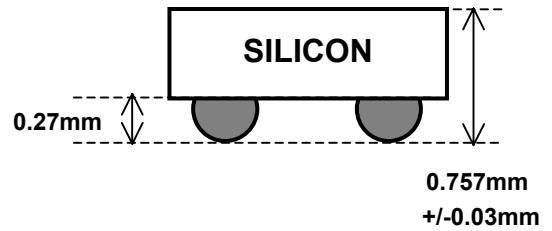
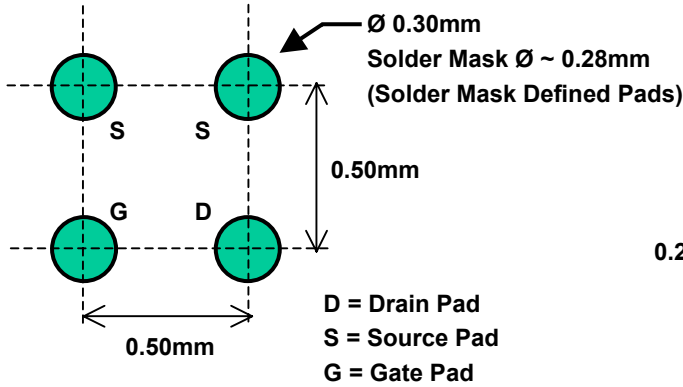

#### LAND PATTERN RECOMMENDATION

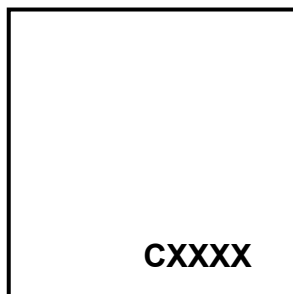

**BACKSIDE VIEW (No Bump Side View)**  
 Mark on backside of die  
 C = 4405P Product Code  
 XXXX = Lot Traceability Code  
 Mark is located in lower right quadrant  
 on top of Drain pad. Gate pad is located  
 in lower left quadrant.

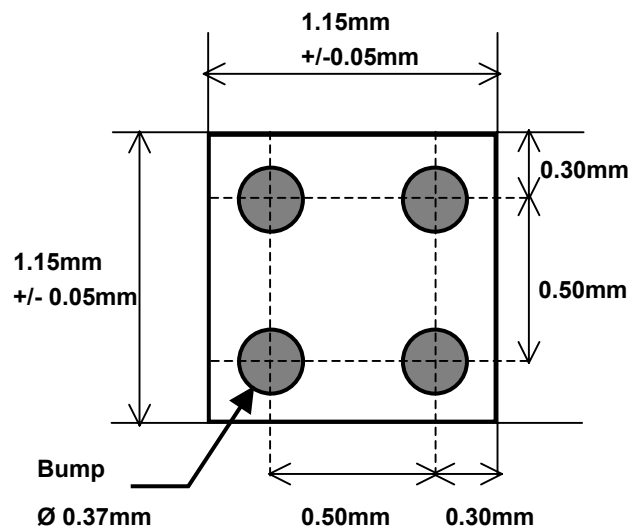

Bumps are Lead Free solder 96.8 Sn / 2.6 Ag / 0.6 Cu

Patents are pending on the product described in the data sheet.

Lateral Power™ and MicroSURF™ are trademarks of Great Wall Semiconductor Corporation.

## BGA FET Tape and reel Specification

### 1. Tape and Reel

- 1.1. Reel Size: 7 inch diameter.
- 1.2. Qty / Reel: 3,000pcs
- 1.3. Peel Strength:
  - 1.3.1. Peel strength must be between 20 to 80 grams.
  - 1.3.2. Minimum peel back length is 150 mm.
  - 1.3.3. Peel back speed must be between 300 +/-5 mm per minute.
  - 1.3.4. Peel back angle must be between 165 to 185 degrees with respect to the component carrier along the longitudinal axis of the carrier tape.
  - 1.3.5. Peel strength test must be performed at the trailer.
- 1.4. Part Orientation: Marking in upper right quadrant

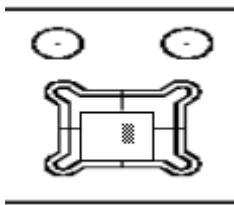

### 2. Tape Leader and Trailer

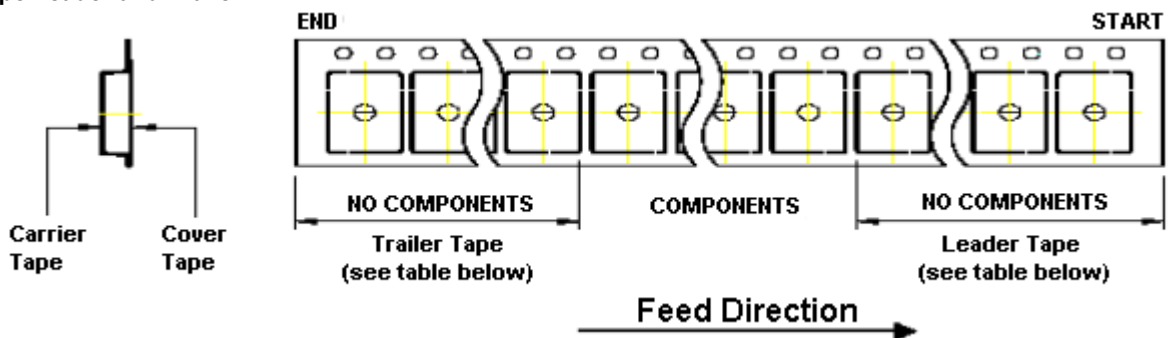

Die Size	Leader	Trailer
1.1 mm x 1.1 mm	500 mm	160 mm

### 3. Tape Dimension

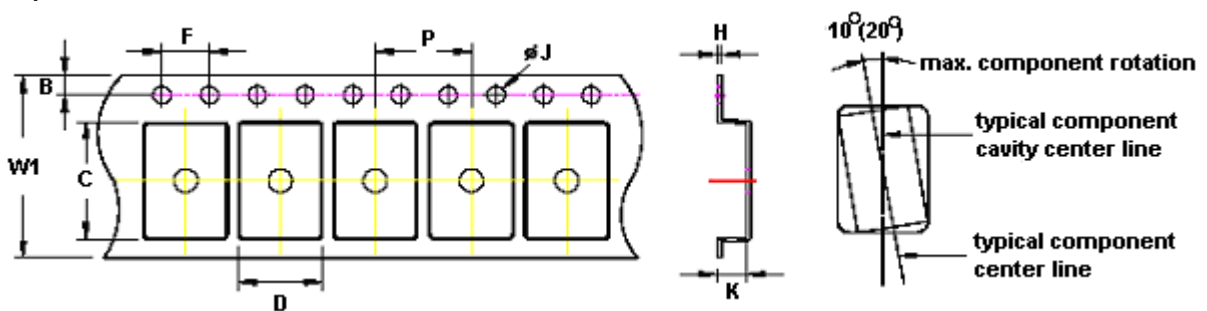

Die Size	Tape size	W1	C	D	K	H	P	F	B
1.1 x 1.1 x 0.8	8	8.0+0.3 - 0.1	1.45±0.10	1.47±0.10	0.91±0.10	0.254±0.02	4.0	4.0	1.75±0.1