

N-Channel Power MOSFET

100V, 70A, 13mΩ

FEATURES

- Low $R_{DS(ON)}$ to minimize conductive loss
- Low gate charge for fast power switching
- Compliant to RoHS directive 2011/65/EU and in accordance to WEEE 2002/96/EC
- Halogen-free according to IEC 61249-2-21

APPLICATION

- Synchronous Rectifier in SMPS
- LED lighting application
- 48V Battery System

KEY PERFORMANCE PARAMETERS		
PARAMETER	VALUE	UNIT
V_{DS}	100	V
$R_{DS(on)}$ (max)	13	mΩ
Q_g	145	nC



TO-251 (IPAK)

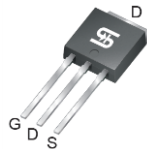

TO-251S (IPAK SL)

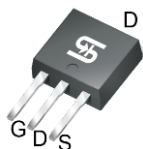

TO-252 (DPAK)

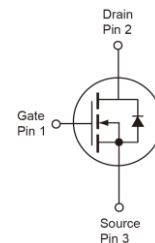
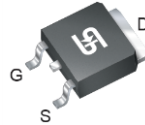

Notes: MSL 3 (Moisture Sensitivity Level) per J-STD-020

ABSOLUTE MAXIMUM RATINGS ($T_A = 25^\circ\text{C}$ unless otherwise noted)			
PARAMETER	SYMBOL	Limit	UNIT
Drain-Source Voltage	V_{DS}	100	V
Gate-Source Voltage	V_{GS}	± 20	V
Continuous Drain Current (Note 3)	I_D	$T_C = 25^\circ\text{C}$	70
		$T_C = 70^\circ\text{C}$	61
		$T_A = 25^\circ\text{C}$	12
		$T_A = 70^\circ\text{C}$	9
Drain Current-Pulsed (Note 1)	I_{DM}	150	A
Avalanche Current, $L=0.5\text{mH}$	I_{AS}, I_{AR}	25	A
Avalanche Energy, $L=0.5\text{mH}$	E_{AS}, E_{AR}	156	mJ
Maximum Power Dissipation (Note 2)	I_D	$T_C = 25^\circ\text{C}$	120
		$T_C = 70^\circ\text{C}$	80
		$T_A = 25^\circ\text{C}$	8.3
		$T_A = 70^\circ\text{C}$	5.3
Storage Temperature Range	T_{STG}	- 55 to +150	$^\circ\text{C}$
Operating Junction Temperature Range	T_J	- 55 to +150	$^\circ\text{C}$

THERMAL PERFORMANCE			
PARAMETER	SYMBOL	Limit	UNIT
Thermal Resistance – Junction to Case	$R_{\theta JC}$	1	$^{\circ}\text{C}/\text{W}$
Thermal Resistance – Junction to Ambient	$R_{\theta JA}$	40	$^{\circ}\text{C}/\text{W}$

ELECTRICAL SPECIFICATIONS ($T_A = 25^{\circ}\text{C}$ unless otherwise noted)						
PARAMETER	CONDITIONS	SYMBOL	MIN	TYP	MAX	UNIT
Static						
Drain-Source Breakdown Voltage	$V_{GS} = 0\text{V}, I_D = 250\mu\text{A}$	BV_{DSS}	100	--	--	V
Drain-Source On-State Resistance	$V_{GS} = 10\text{V}, I_D = 30\text{A}$	$R_{DS(ON)}$	--	10	13	m Ω
Gate Threshold Voltage	$V_{DS} = V_{GS}, I_D = 250\mu\text{A}$	$V_{GS(TH)}$	2	3	4	V
Zero Gate Voltage Drain Current	$V_{DS} = 80\text{V}, V_{GS} = 0\text{V}$	I_{DSS}	--	--	1	μA
Gate Body Leakage	$V_{GS} = \pm 20\text{V}, V_{DS} = 0\text{V}$	I_{GSS}	--	--	± 100	nA
Dynamic						
Total Gate Charge	$V_{DS} = 50\text{V}, I_D = 30\text{A},$ $V_{GS} = 10\text{V}$	Q_g	--	145	--	nC
Gate-Source Charge		Q_{gs}	--	25	--	
Gate-Drain Charge		Q_{gd}	--	43	--	
Input Capacitance	$V_{DS} = 30\text{V}, V_{GS} = 0\text{V},$ $f = 1.0\text{MHz}$	C_{iss}	--	4300	--	pF
Output Capacitance		C_{oss}	--	300	--	
Reverse Transfer Capacitance		C_{rss}	--	120	--	
Switching						
Turn-On Delay Time	$V_{GS} = 10\text{V}, V_{DS} = 50\text{V},$ $R_G = 3\Omega,$	$t_{d(on)}$	--	27	--	ns
Turn-On Rise Time		t_r	--	13	--	
Turn-Off Delay Time		$t_{d(off)}$	--	15	--	
Turn-Off Fall Time		t_f	--	42	--	
Source-Drain Diode						
Forward On Voltage	$V_{GS} = 0\text{V}, I_S = 30\text{A}$	V_{SD}	--	0.8	1.3	V
Reverse Recovery Time	$I_S = 30\text{A}, T_J = 25^{\circ}\text{C}$ $dI_F/dt = 100\text{A}/\mu\text{s}$	t_{rr}	--	165	--	ns
Reverse Recovery Charge		Q_{rr}	--	175	--	nC

Notes:

- Pulse Test: Pulse Width $\leq 300\mu\text{s}$, Duty Cycle $\leq 2\%$
- $R_{\theta JA}$ is the sum of the junction-to-case and case-to-ambient thermal resistances. The case thermal reference is defined at the solder mounting surface of the drain pins. $R_{\theta JA}$ is guaranteed by design while $R_{\theta CA}$ is determined by the user's board design. $R_{\theta JA}$ shown below for single device operation on FR-4PCB in still air.
- The maximum current is limited by package.

ORDERING INFORMATION

PART NO.	PACKAGE	PACKING
TSM70N10CP ROG	TO-252 (DPAK)	2,500pcs / 13" Reel
TSM70N10CH C5G	TO-251 (IPAK)	75pcs / Tube
TSM70N10CH X0G	TO-251S (IPAK SL)	75pcs / Tube

CHARACTERISTICS CURVES

($T_A = 25^\circ\text{C}$ unless otherwise noted)

Output Characteristics

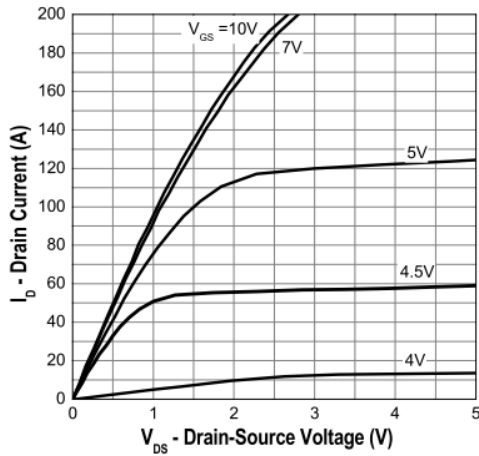

Transfer Characteristics

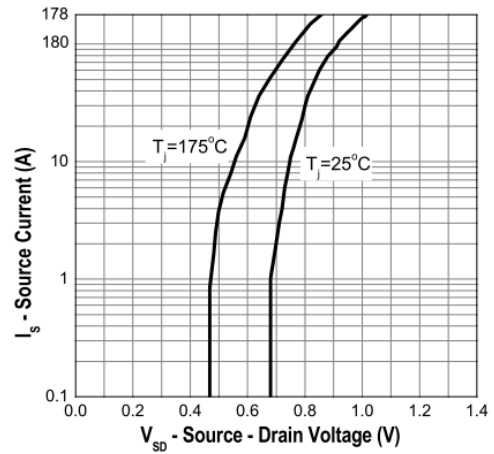

On-Resistance vs. Gate-Source Voltage

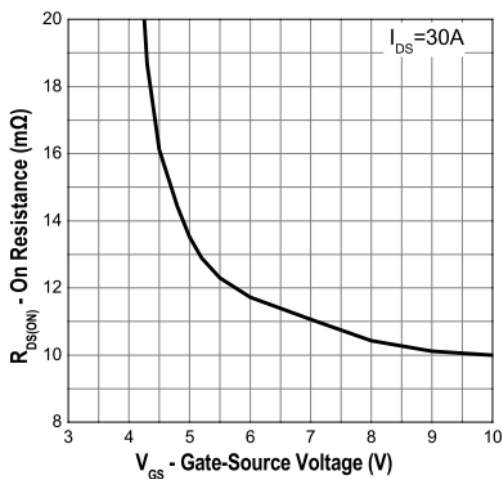

Gate Charge

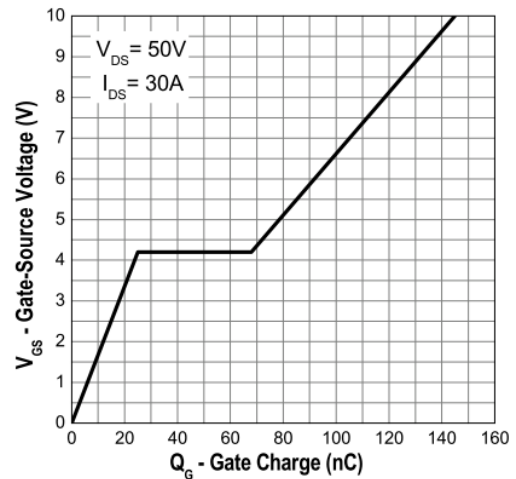

On-Resistance vs. Junction Temperature

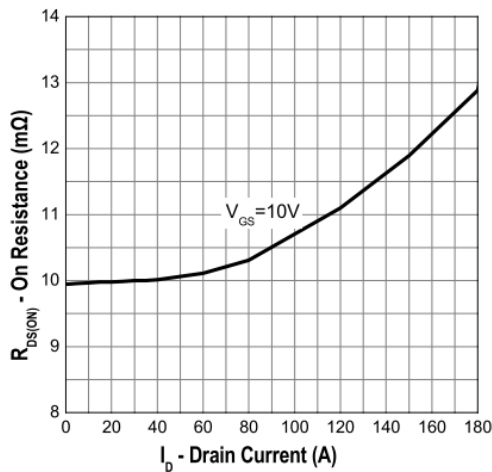

Capacitance

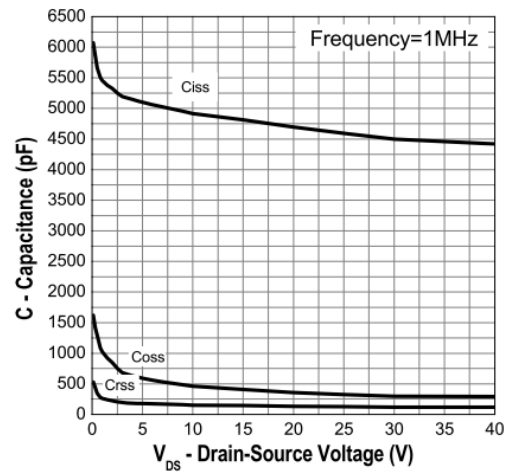

CHARACTERISTICS CURVES

($T_A = 25^\circ\text{C}$ unless otherwise noted)

Maximum Safe Operating Area

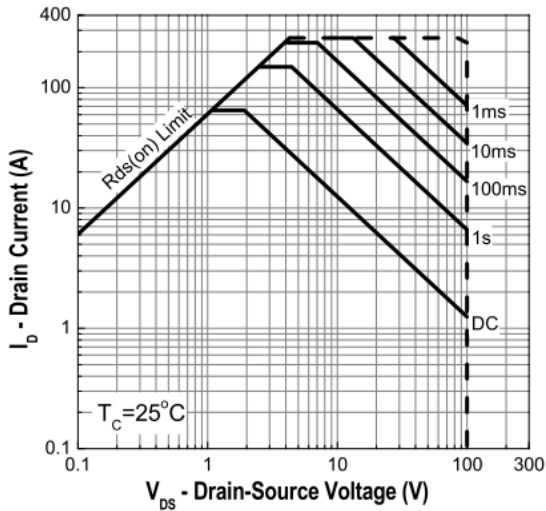

Threshold Voltage vs. Temperature

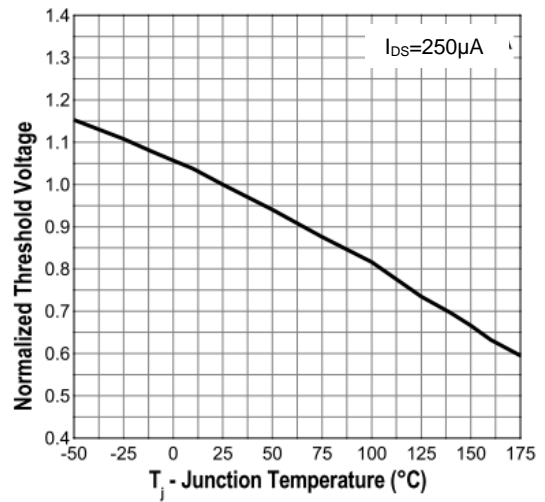

Normalized Thermal Transient Impedance, Junction-to-Ambient

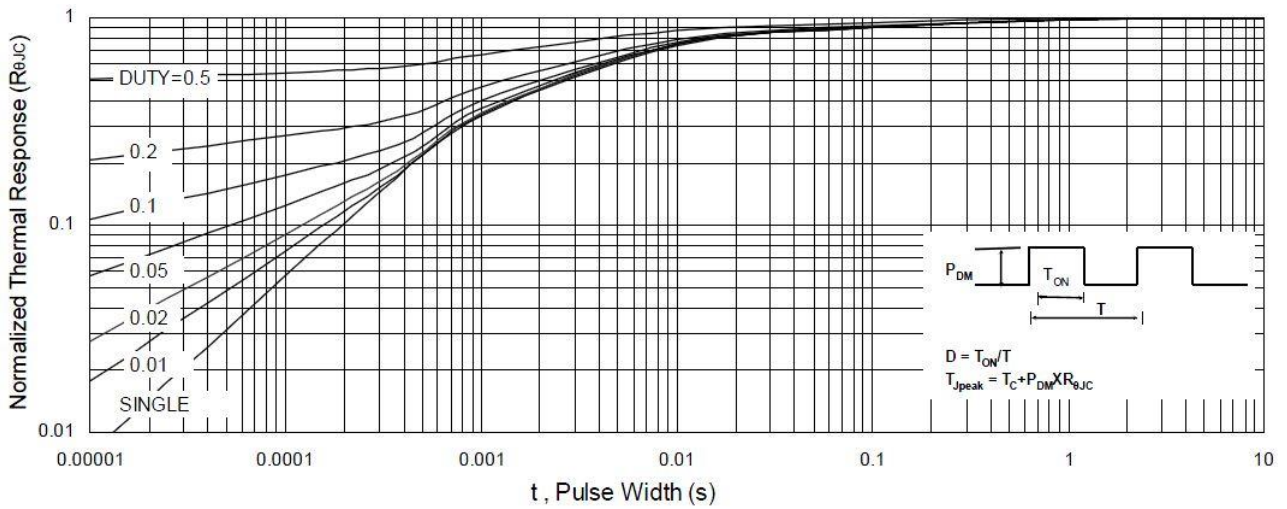

PACKAGE OUTLINE DIMENSIONS (Unit: Millimeters)

TO-252

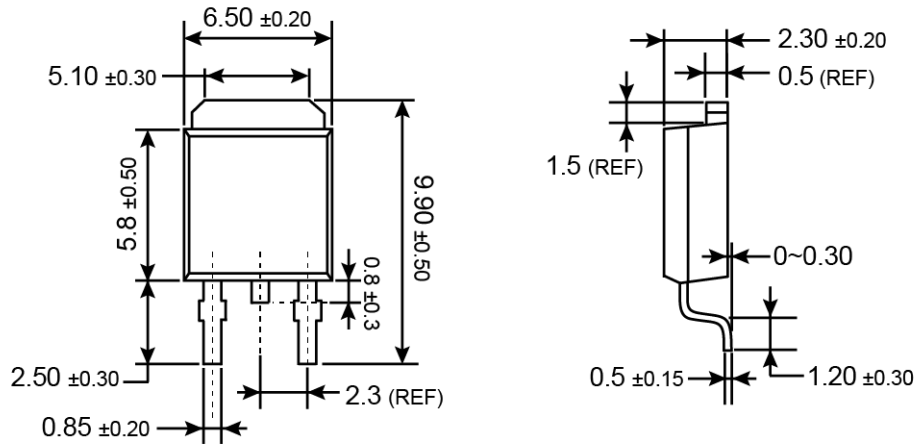

SUGGESTED PAD LAYOUT (Unit: Millimeters)

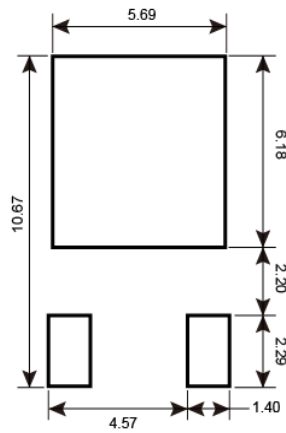

MARKING DIAGRAM

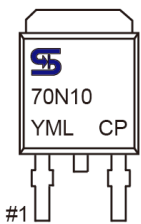

- Y** = Year Code
- M** = Month Code for Halogen Free Product
 - O** =Jan **P** =Feb **Q** =Mar **R** =Apr
 - S** =May **T** =Jun **U** =Jul **V** =Aug
 - W** =Sep **X** =Oct **Y** =Nov **Z** =Dec
- L** = Lot Code (1~9, A~Z)

PACKAGE OUTLINE DIMENSIONS (Unit: Millimeters)

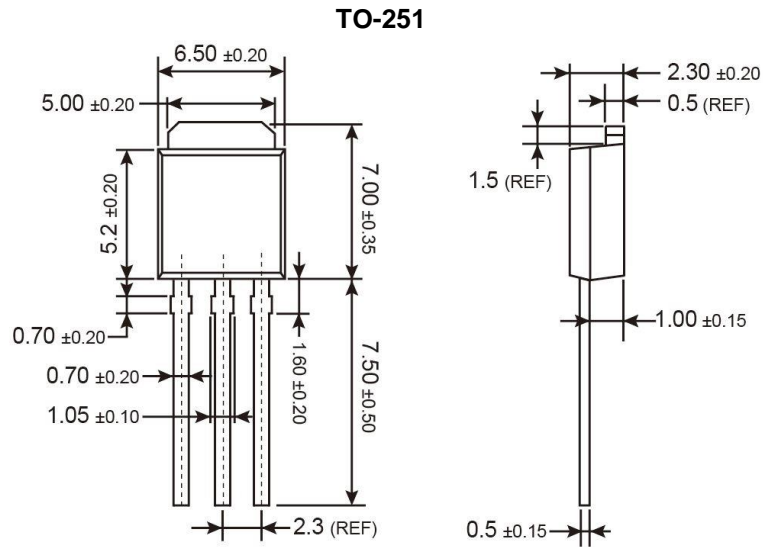

MARKING DIAGRAM

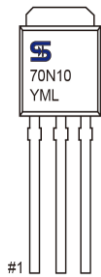

- Y** = Year Code
- M** = Month Code for Halogen Free Product
 - O** =Jan **P** =Feb **Q** =Mar **R** =Apr
 - S** =May **T** =Jun **U** =Jul **V** =Aug
 - W** =Sep **X** =Oct **Y** =Nov **Z** =Dec
- L** = Lot Code (1~9, A~Z)

PACKAGE OUTLINE DIMENSIONS (Unit: Millimeters)

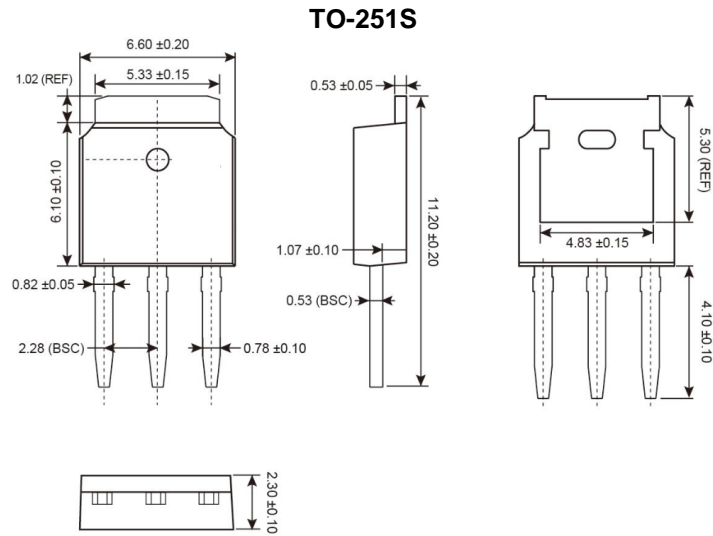

MARKING DIAGRAM

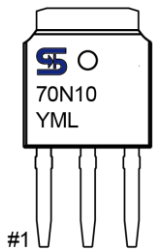

- Y** = Year Code
- M** = Month Code for Halogen Free Product
 - O** =Jan **P** =Feb **Q** =Mar **R** =Apr
 - S** =May **T** =Jun **U** =Jul **V** =Aug
 - W** =Sep **X** =Oct **Y** =Nov **Z** =Dec
- L** = Lot Code (1~9, A~Z)

Notice

Specifications of the products displayed herein are subject to change without notice. TSC or anyone on its behalf, assumes no responsibility or liability for any errors or inaccuracies.

Information contained herein is intended to provide a product description only. No license, express or implied, to any intellectual property rights is granted by this document. Except as provided in TSC's terms and conditions of sale for such products, TSC assumes no liability whatsoever, and disclaims any express or implied warranty, relating to sale and/or use of TSC products including liability or warranties relating to fitness for a particular purpose, merchantability, or infringement of any patent, copyright, or other intellectual property right.

The products shown herein are not designed for use in medical, life-saving, or life-sustaining applications. Customers using or selling these products for use in such applications do so at their own risk and agree to fully indemnify TSC for any damages resulting from such improper use or sale.