



DATA SHEET

TSP058A~TSP320A

AXIAL LEAD BI-DIRECTIONAL THYRISTOR SURGE PROTECTOR DEVICE

FEATURES

- Protects by limiting voltages and shunting surge currents away from sensitive circuits
- Designed for telecommunications applications such as line cards, modems, PBX, FAX, LAN, VHD SL
- Helps meet standards such as GR1089, ITU K.20, IEC950, UL1459&50, FCC part 68
- Low capacitance, High surge (A, B, C rating available), precise voltage limiting, Long life

MECHANICAL DATA

- Case: JEDEC DO-15 molded plastic
- Terminals: Plated Axial leads, solderable per MIL-STD-750, Method 2026
- Polarity: Bi-directional
- Weight: 0.015 ounce, 0.4 gram

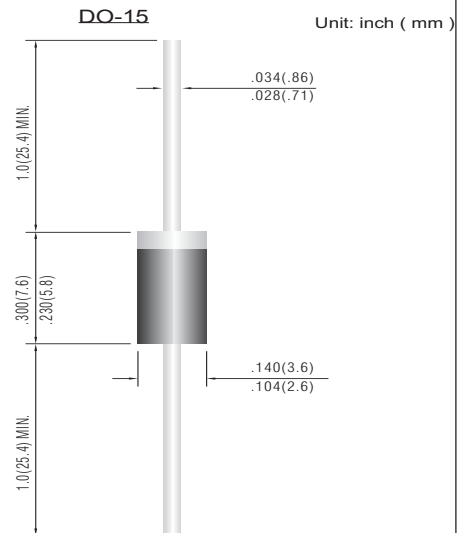

SUMMARY ELECTRICAL CHARACTERISTICS

Part Number	Rated Repetitive Peak Off-State Voltage	Breakover Voltage	On-State Voltage	Repetitive Peak Off-State Current	Breakover Current	Holding Current	Off-State Capacitance (f = 1 MHz, Vac = 15 mVRMS)			
	Max.	Max.	Max.	Max.	Max.	Min.	Typ.	Max.	Typ.	Max.
	V _{DRM}	V _{BO @ I_{BO}}	V _{T @ 1A}	I _{DRM}	I _{BO}	I _H	Co @ 0 V _{dc}		Co @ 50 V _{dc}	
	V	V	V	μA	mA	mA	pF		pF	
TSP058A	58	77	5	5	800	150	44	66	16	24
TSP065A	65	88	5	5	800	150	39	64	15	23
TSP075A	75	98	5	5	800	150	37	57	13	20
TSP090A	90	130	5	5	800	150	34	54	12	18
TSP120A	120	160	5	5	800	150	32	48	12	17
TSP140A	140	180	5	5	800	150	29	47	9	16
TSP160A	160	220	5	5	800	150	28	43	9	15
TSP190A	190	260	5	5	800	150	28	40	8	14
TSP220A	220	300	5	5	800	150	27	40	8	14
TSP275A	275	350	5	5	800	150	27	38	8	13
TSP320A	320	400	5	5	800	150	27	38	8	13
notes	(1,3)	(3,5,6)	(3)	(3)	(3)	(2,3)	(3)	(3)	(3)	(3)

NOTES:

1. Specific V_{DRM} values are available by request.
2. Specific I_H values are available by request.
3. All ratings and characteristics are at 25 °C unless otherwise specified.
4. V_{DRM} applies for the life of the device. I_{DRM} will be in spec during and following operation of the device.
5. V_{BO1} is at 100V/msec, I_{SC} = 10A_{pk}, V_{OC} = 1KV_{pk}, 10/1000 Waveform
6. V_{BO2} is at f = 60 Hz, I_{SC} = 1 A_(RMS), Vac = 1KV_(RMS), RL = 1 KW, 1/2 AC cycle



CAPACITANCE CHARACTERISTICS

F = 1 MHz, $V_{ac} = 15\text{ mV}_{rms}$

Part Number	Off-State Capacitance C_o									
	pF									
	0 Vdc		1 Vdc		2 Vdc		5 Vdc		50 Vdc	
	Typ.	Max.	Typ.	Max.	Typ.	Max.	Typ.	Max.	Typ.	Max.
TSP058A	44	66	40	51	36	49	33	44	16	24
TSP065A	39	64	35	49	31	47	28	42	15	23
TSP075A	37	57	33	42	29	40	26	35	13	20
TSP090A	34	54	30	39	26	37	23	32	12	18
TSP120A	32	48	28	33	24	31	21	26	12	17
TSP140A	29	47	25	32	21	30	18	25	9	16
TSP160A	28	43	25	27	21	24	18	20	9	15
TSP190A	28	40	24	25	20	23	17	18	8	14
TSP220A	27	40	23	25	19	23	16	18	8	14
TSP275A	27	38	23	24	19	22	16	17	8	13
TSP320A	27	38	23	24	19	22	16	17	8	13

RATING AND CHARACTERISTIC CURVES

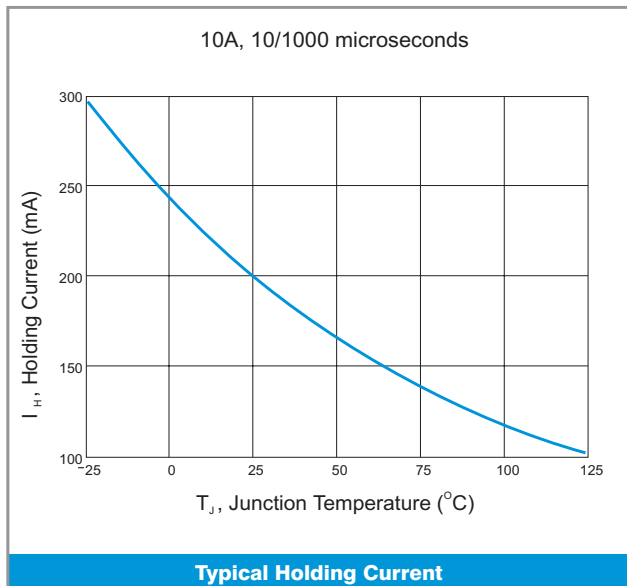
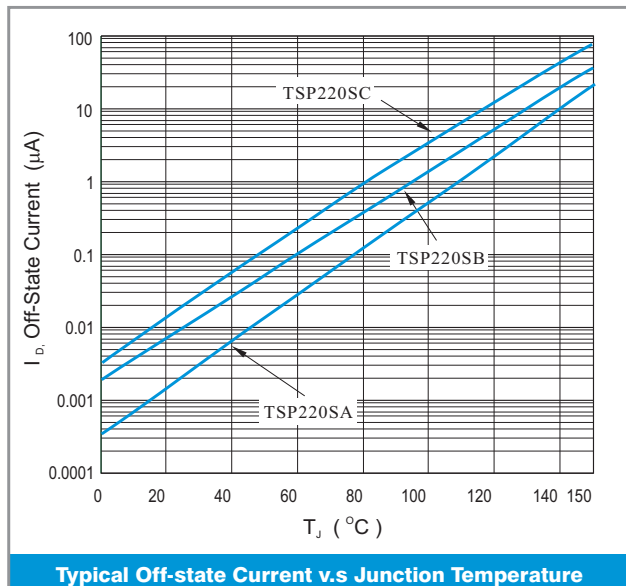
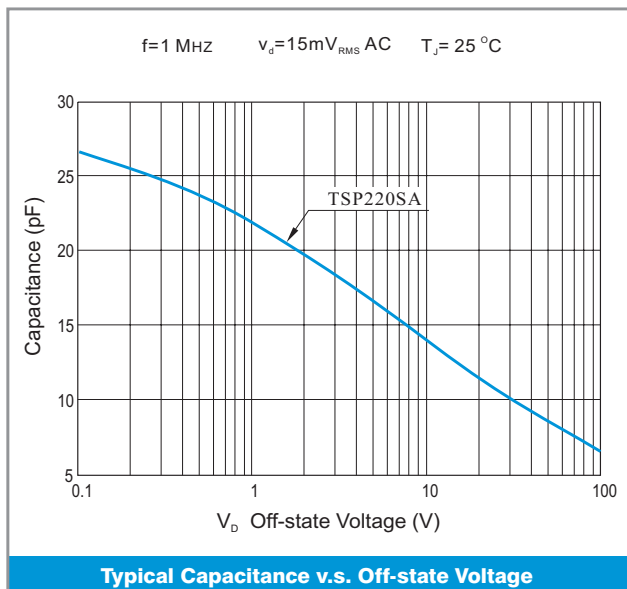
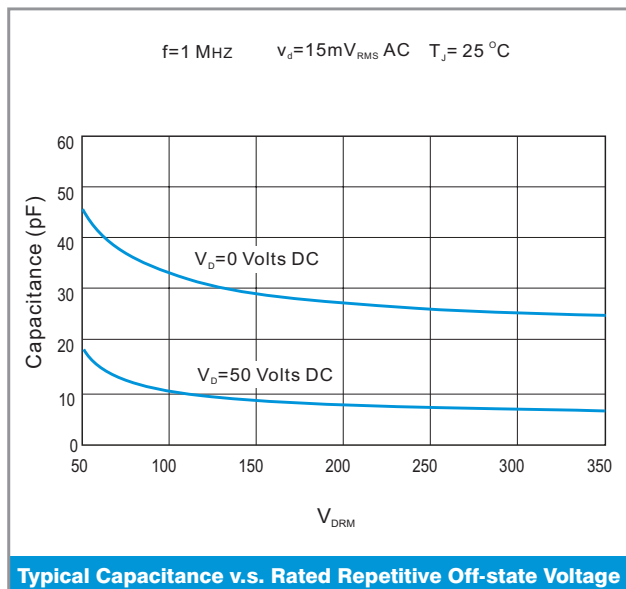



RATING AND CHARACTERISTIC CURVES

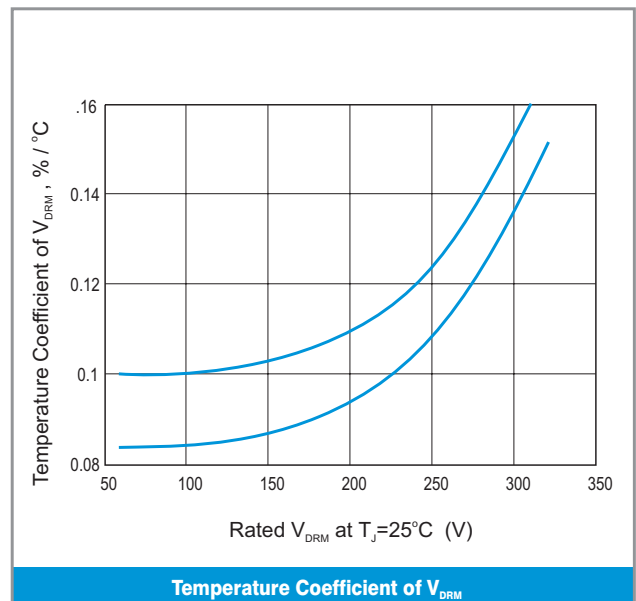
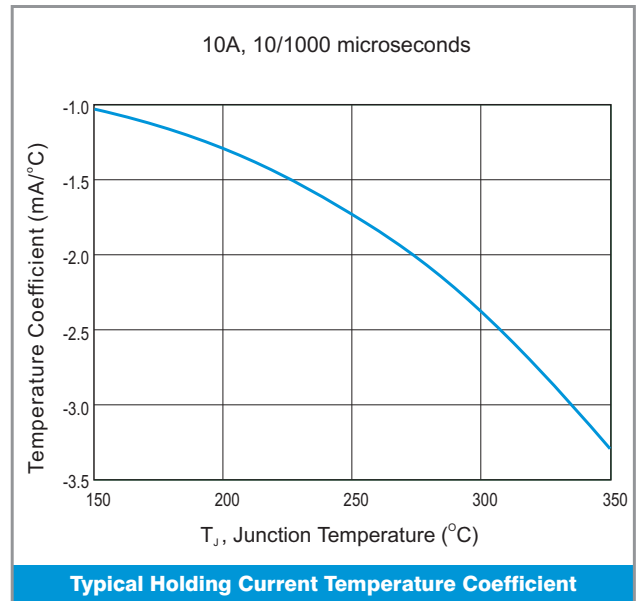
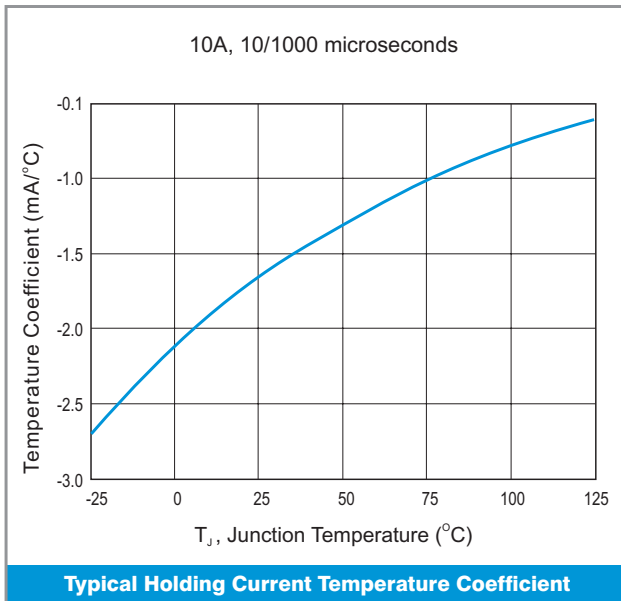

IMPORTANT NOTICE

This information is intended to unambiguously characterize the product in order to facilitate the customer's evaluation of the device in the application. It will help the customer's technical experts determine that the device is compatible and interchangeable with similar devices made by other vendors. The information in this data sheet is believed to be reliable and accurate. The specifications and information herein are subject to change without notice. New products and improvements in products and their characterization are constantly in process. This provides a superior performing and the highest value product. The factory should be consulted for the most recent information and for any special characteristics not described or specified.

© Copyright Panjit International Inc. 2001

All rights are reserved. Reproduction in whole or in part is prohibited without the prior written consent of the copyright owner.

The information presented in this document does not form part of any quotation or contract, is believed to be accurate and reliable and may be changed without notice. No liability will be accepted by the publisher for any consequence of its use.

Publication thereof does not convey nor imply any license under patent- or other industrial or intellectual property rights.

PanJit International Inc.

<http://www.panjit.com.tw> email: sales@panjit.com.tw



SELECTION GUIDE

Follow these steps to select the proper Thyristor surge protector for your application:

1. Define the operating parameters for the circuit:
 - Ambient operating temperature range
 - Maximum telephone line operating current (highest battery and shortest copper loop)
 - Maximum operating voltage: (Maximum DC bias + peak ringing voltage)
 - Maximum surge current
 - System voltage damage threshold
 - Select device with an off-state voltage rating (V_{DRM}) above the maximum operating voltage at the minimum operating temperature.
3. Select surge current ratings (I_{PPS} and I_{TSM}) ³ those which the application must withstand.
4. Verify that the minimum holding current of the device at the maximum ambient temperature is above the maximum dc current of the system.
5. Verify that the maximum breakover voltage of the device is below the system damage threshold.
6. Verify that the circuit's ambient operating temperatures are within the device's operating temperature range.
7. Verify that the device's dimensions fit the application's space considerations.
8. Independently evaluate and test the suitability and performance of the device in the application

MAXIMUM SURGE RATINGS ($T_J = 25\text{ }^\circ\text{C}$ UNLESS OTHERWISE NOTED)

Rating	Non-Repetitive Peak Pulse Current						Non-Repetitive Peak On-State Surge Current
Symbol	I_{PPS}						I_{TSM}
Short-Circuit Current Wave	2/10 μs	8/20 μs	10/160 μs	5/310 μs	10/560 μs	10/1000 μs	20A
Open-Circuit Voltage Wave	2/10 μs	1.2/50 μs	10/160 μs	10/700 μs	10/560 μs	10/1000 μs	
Value	175 A	150 A	100 A	85 A	70 A	50 A	
Notes	(1,2,4,5,6)						(1,2,3,4)

Notes:

1. Thermal accumulation between successive surge tests is not allowed.
2. The device under test initially must be in thermal equilibrium with $T_J = 25\text{ }^\circ\text{C}$.
3. Test at 1 cycle, 60 Hz.
4. Surge ratings are non-repetitive because instantaneous junction temperatures may exceed the maximum rated T_J . Nevertheless, devices will survive many surge applications without degradation. Surge capability will not degrade over a device's typical operating life.
5. Adjust the surge generator for optimum current-wave accuracy when both voltage and current wave specifications cannot be exactly met. The current wave is more important than the voltage wave for accurate surge evaluation.
6. The waveform is defined as A/B ms where:
 - A: (Virtual front time) = $1.25 \times \text{Rise time} = 1.25 \times (T_b - T_a)$
 - B: (Duration time to 50% level of I_{pps}) = $T_1 - T_0$

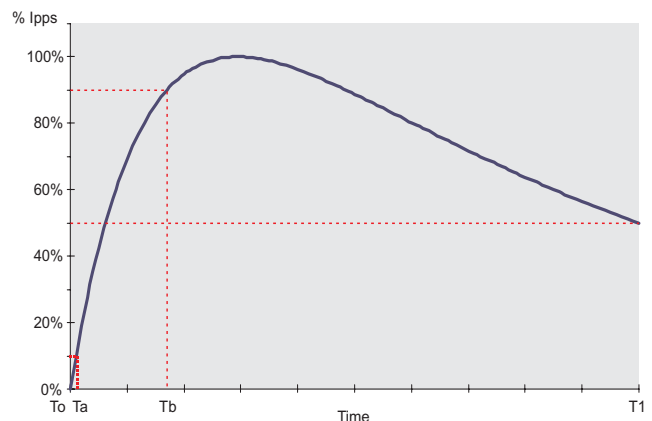



MAXIMUM THERMAL RATINGS

Rating	Symbol	Value	Unit
Storage Junction Temperature Range	T _{STG}	-50 to 150	°C
Operating Junction Temperature Range	T _J	-40 to 150	°C
Operating Ambient Temperature Range	T _a	-40 to 65	°C

Notes:

PCB board mounted on minimum foot print.

THERMAL CHARACTERISTICS

Characteristic	Symbol	Value	Unit
Thermal Resistance Junction to Leads T _L on tab adjacent to plastic. Both leads soldered to identical pad sizes.	R _{θJL}	Max. 20	°C / W

Notes:

The junction to lead thermal resistance represents a minimum limiting value with both leads soldered to a large near-infinite heatsink. The junction to ambient thermal resistance depends strongly on board mounting conditions and typically is 3 to 6 times higher than the junction to lead resistance. The data shown is to be used as guideline values for preliminary engineering.

ELECTRICAL CHARACTERISTICS (T_c = 25°C UNLESS OTHERWISE NOTED)

Parameters	Test Conditions	Symbol	Min.	Max.	Unit
Repetitive Peak Off-State Current	V _D = rated V _{DRM}	I _{DRM}		5	μA
Breakover Current	f = 60 Hz, I _{sc} = 1 Arms, V _{ac} = 1 KVrms, R _L = 1 KΩ, 1/2 AC cycle	I _{BO}		800	mA
Holding Current ¹	10/1000μs waveform, I _{sc} = 10A, V _{oc} = 62 V, R _L = 400 Ω	I _H	150		mA
On-State Voltage	I _T = 1 A, T _w = 300 μs, 1 pulse	V _T		5	V

Notes:

Specific I_H values are available by request.

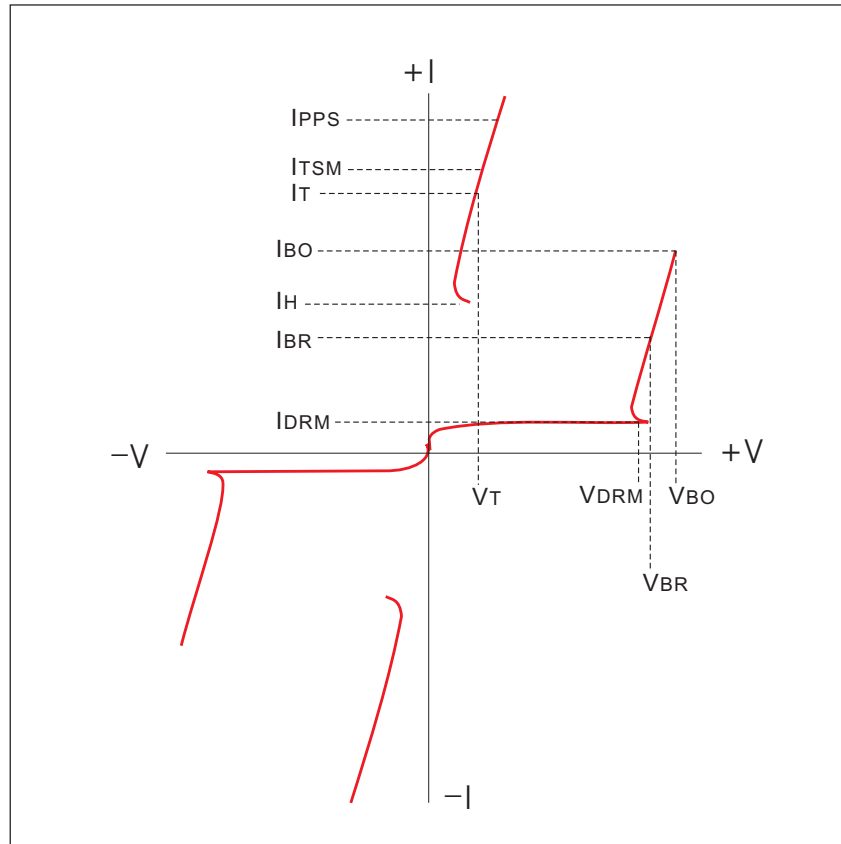

Characteristic	Symbol	Value
V_{BO}	Breakover Voltage	Maximum voltage across the device in or at breakdown measured under a specified voltage and current rate of rise
I_{BO}	Breakover Current	Instantaneous current flowing at the breakover voltage (V_{BO})
I_H	Holding Current	Minimum current required to maintain the device in the on-state
I_T	On-state current	Current through the device in the on-state condition
V_T	On-state voltage	Voltage across the device in the on-state condition at a specified current (I_T)
V_{DRM}	Rated Repetitive Peak Off-State Voltage	The highest instantaneous value of the off-state voltage, including all repetitive transient voltages but excluding all nonrepetitive transient voltages
I_{DRM}	Repetitive Peak Off-State Current	The maximum (peak) value of current that results from the application of V_{DRM}
I_{PPS}	Non-Repetitive Peak pulse current	Rated maximum value of peak impulse current of specified amplitude and waveshape that may be applied without damage to the device under test
di/dt	Critical rate of rise of on-state current	Rated value of the rate of rise of current that the device can withstand without damage.
dv/dt	Critical Rate of Rise of Off-State Voltage	The maximum rate of rise of voltage (below V_{DRM}) that will not cause switching from the off-state to the on-state.