

TSP70R450S1

700V 10.5A N-Channel SJ-MOSFET

General Description

Truesemi SJ-FET is new generation of high voltage MOSFET family that is utilizing an advanced charge balance mechanism for outstanding low on-resistance and lower gate charge performance. This advanced technology has been tailored to minimize conduction loss, provide superior switching performance, and withstand extreme dv/dt rate and higher avalanche energy. SJ-FET is suitable for various AC/DC power conversion in switching mode operation for higher efficiency.

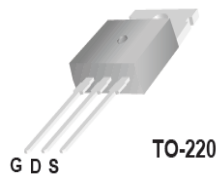

Features

- 750V @ $T_J = 150^\circ\text{C}$
- Typ. $R_{DS(on)} = 0.42\Omega$
- Ultra Low gate charge (typ. $Q_g = 38\text{nC}$)
- 100% avalanche tested

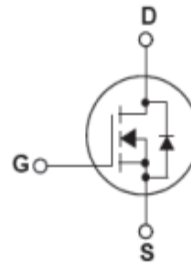

Absolute Maximum Ratings

Symbol	Parameter	Value	Unit
V_{DSS}	Drain-Source Voltage	700	V
I_D	Drain Current	-Continuous ($TC = 25^\circ\text{C}$)	10.5
		-Continuous ($TC = 100^\circ\text{C}$)	6.7
I_{DM}	Drain Current – Pulsed (Note 1)	30	A
V_{GSS}	Gate-Source voltage	± 30	V
E_{AS}	Single Pulsed Avalanche Energy (Note 2)	210	mJ
I_{AR}	Avalanche Current (Note 1)	1.8	A
E_{AR}	Repetitive Avalanche Energy (Note 1)	0.32	mJ
dv/dt	Peak Diode Recovery dv/dt (Note 3)	15	V/ns
P_D	Power Dissipation ($TC = 25^\circ\text{C}$)		83
		-Derate above 25°C	1.67
T_J, T_{STG}	Operating and Storage Temperature Range	-55 to +150	$^\circ\text{C}$
T_L	Maximum Lead Temperature for Soldering Purpose, 1/8" from Case for 5 Seconds	300	$^\circ\text{C}$

* Drain current limited by maximum junction temperature.

Thermal Characteristics

Symbol	Parameter	Value	Unit
$R_{\theta JC}$	Thermal Resistance, Junction-to-Case	1.5	$^\circ\text{C/W}$
$R_{\theta CS}$	Thermal Resistance, Case-to-Sink Typ.	0.5	$^\circ\text{C/W}$
$R_{\theta JA}$	Thermal Resistance, Junction-to-Ambient	62	$^\circ\text{C/W}$

Electrical Characteristics TC = 25 °C unless otherwise noted

Symbol	Parameter	Conditions	Min	Typ	Max	Unit
Off Characteristics						
BV _{DSS}	Drain-Source Breakdown Voltage	V _{GS} = 0V, I _D = 250μA, T _J = 25 °C	700	--	--	V
		V _{GS} = 0V, I _D = 250μA, T _J = 150 °C	--	750	--	V
ΔBV _{DSS} / ΔT _J	Breakdown Voltage Temperature Coefficient	I _D = 250μA, Referenced to 25 °C	--	0.6	--	V/°C
I _{DSS}	Zero Gate Voltage Drain Current	V _{DS} = 700V, V _{GS} = 0V -T _J = 150 °C	--	-- 10	1 --	μA μA
I _{GSSF}	Gate-Body Leakage Current, Forward	V _{GS} = 30V, V _{DS} = 0V	--	--	100	nA
I _{GSSR}	Gate-Body Leakage Current, Reverse	V _{GS} = -30V, V _{DS} = 0V	--	--	-100	nA
On Characteristics						
V _{GS(th)}	Gate Threshold Voltage	V _{DS} = V _{GS} , I _D = 250μA	2.5	--	4.5	V
R _{DS(on)}	Static Drain-Source On-Resistance	V _{GS} = 10V, I _D = 5.5A	--	0.42	0.45	Ω
g _{FS}	Forward Trans conductance	V _{DS} = 40V, I _D = 5.5A (Note 4)	--	16	--	S
R _g	Gate resistance	f=1 MHz, open drain	--	3	--	Ω
Dynamic Characteristics						
C _{iss}	Input Capacitance	V _{DS} = 25V, V _{GS} = 0V, f = 1.0MHz	--	680	--	pF
C _{oss}	Output Capacitance		--	240	--	pF
C _{rss}	Reverse Transfer Capacitance		--	7	--	pF
Switching Characteristics						
t _{d(on)}	Turn-On Delay Time	V _{DD} = 400V, I _D = 5.5A R _G = 20Ω (Note 4, 5)	--	15	--	ns
t _r	Turn-On Rise Time		--	10	--	ns
t _{d(off)}	Turn-Off Delay Time		--	110	--	ns
t _f	Turn-Off Fall Time		--	9	--	ns
Q _g	Total Gate Charge	V _{DS} = 480V, I _D = 5.5A V _{GS} = 10V (Note 4, 5)	--	38	--	nC
Q _{gs}	Gate-Source Charge		--	4	--	nC
Q _{gd}	Gate-Drain Charge		--	4.2	--	nC
Drain-Source Diode Characteristics and Maximum Ratings						
I _S	Maximum Continuous Drain-Source Diode Forward Current		--	--	11	A
I _{SM}	Maximum Pulsed Drain-Source Diode Forward Current		--	--	30	A
V _{SD}	Drain-Source Diode Forward Voltage	V _{GS} = 0V, I _F = 5.5A	--	0.9	1.5	V
t _{rr}	Reverse Recovery Time	V _{GS} = 0V, I _F = 5.5A di _F /dt = 100A/μs (Note 4)	--	270	--	ns
Q _{rr}	Reverse Recovery Charge		--	3.3	--	μC

NOTES:

1. Repetitive Rating: Pulse width limited by maximum junction temperature
2. I_{AS}=1.8A, V_{DD}=50V, Starting T_J=25 °C
3. I_{SD}≤10.5A, di/dt ≤ 200A/μs, V_{DD} ≤ BV_{DSS}, Starting T_J = 25 °C
4. Pulse Test: Pulse width ≤ 300μs, V_{DD}, Duty Cycle ≤ 2%
5. Essentially Independent of Operating Temperature Typical Characteristics

Typical Performance Characteristics

Power dissipation

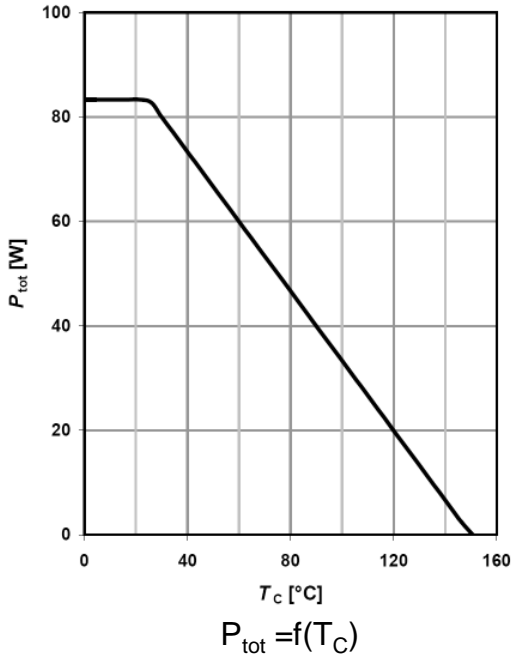

Max. transient thermal impedance

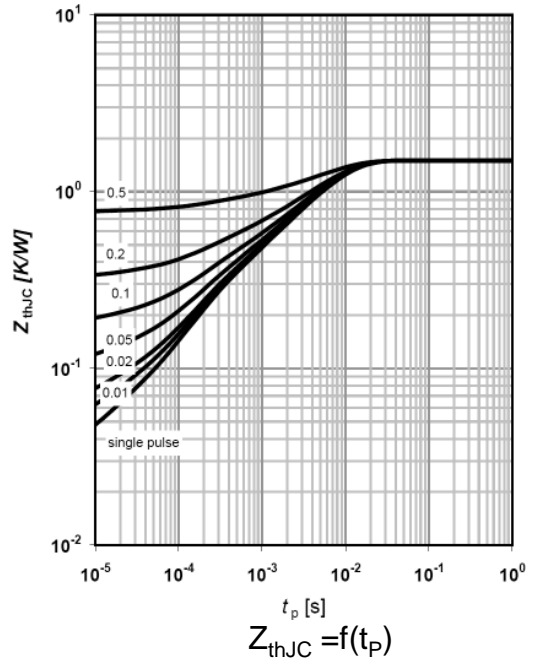

Safe operating area $T_c = 25\text{ }^\circ\text{C}$

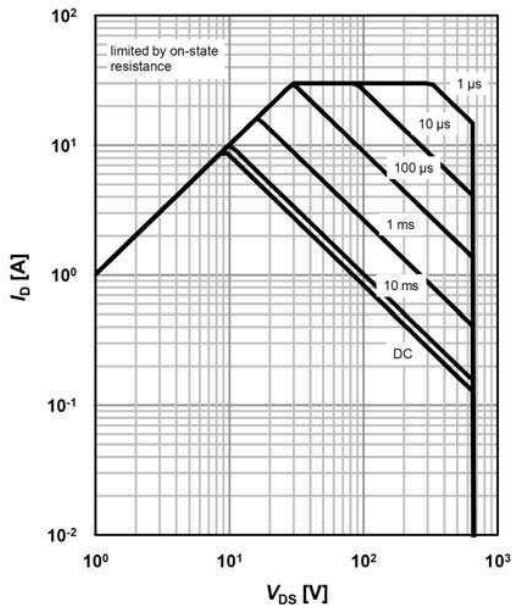

$I_D = f(V_{DS}); T_c = 25\text{ }^\circ\text{C}; V_{GS} > 7\text{V};$
 $D = 0; \text{parameter } t_p$

Safe operating area $T_c = 80\text{ }^\circ\text{C}$

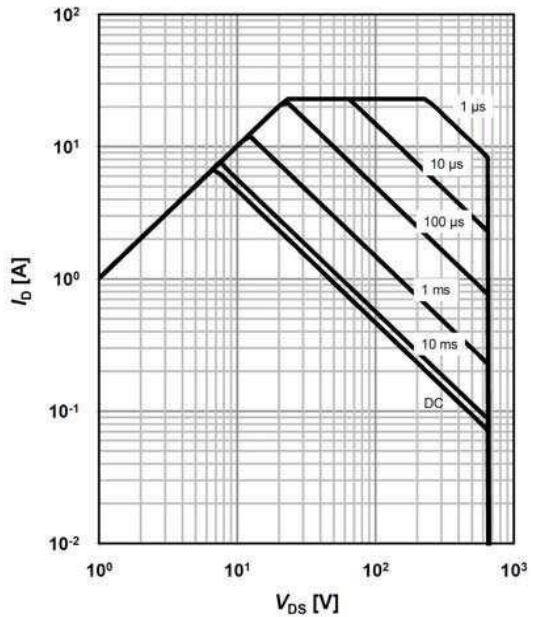

$I_D = f(V_{DS}); T_c = 80\text{ }^\circ\text{C}; V_{GS} > 7\text{V};$
 $D = 0; \text{parameter } t_p$

Typical Performance Characteristics

Typ. output characteristics $T_j=25^\circ\text{C}$

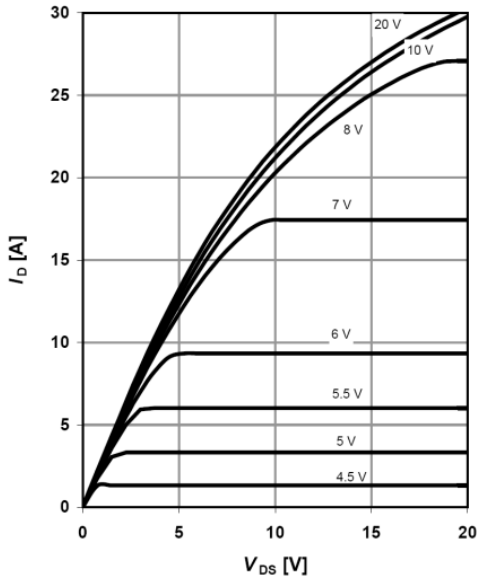

$I_D=f(V_{DS}); T_j=25^\circ\text{C}$; parameter: V_{GS}

Typ. output characteristics $T_j=125^\circ\text{C}$

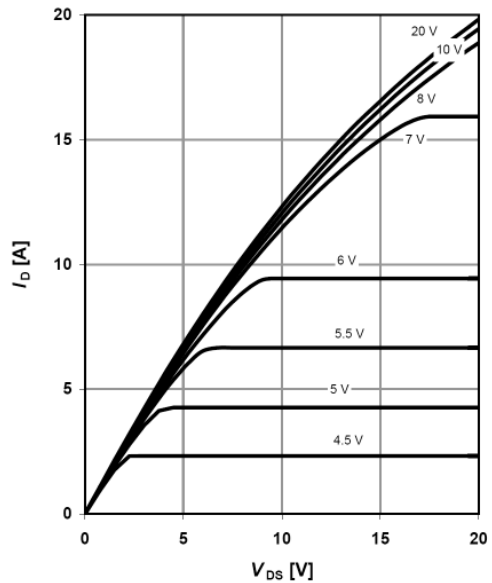

$I_D=f(V_{DS}); T_j=125^\circ\text{C}$; parameter: V_{GS}

Typ. drain-source on-state resistance

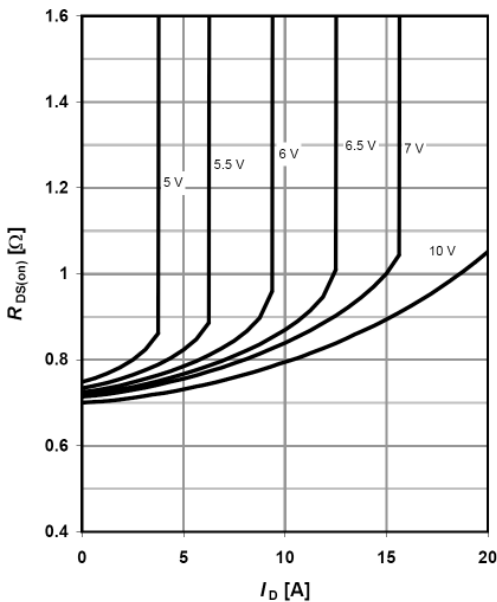

$R_{DS(on)}=f(I_D); T_j=125^\circ\text{C}$;
parameter: V_{GS}

Typ. drain-source on-state resistance

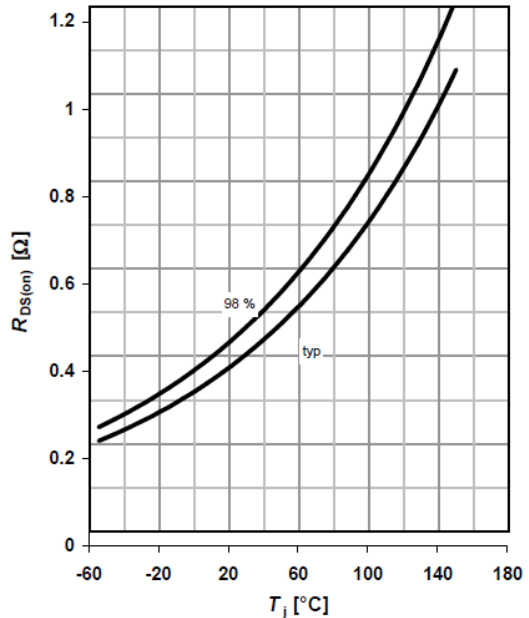

$R_{DS(on)}=f(T_j); I_D=3.2\text{A}; V_{GS}=10\text{V}$

Typical Performance Characteristics

Typ. transfer characteristics

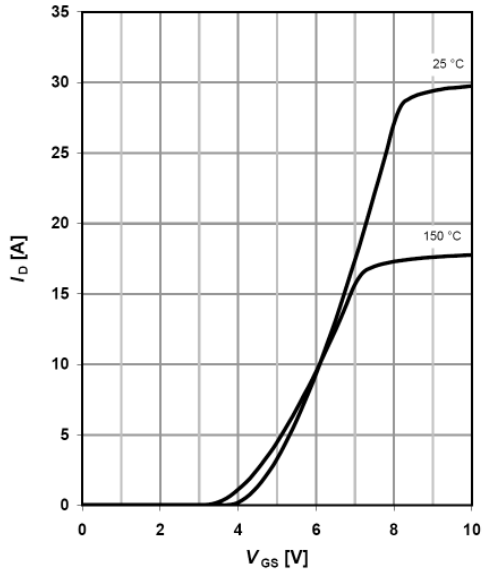

$I_D = f(V_{GS}); V_{DS} = 20V$

Typ. gate charge

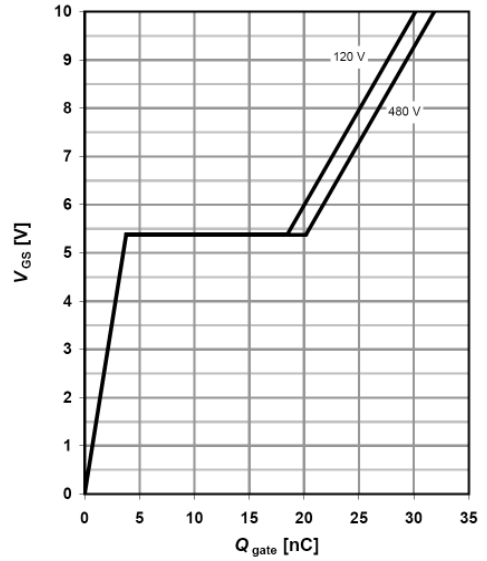

$V_{GS} = f(Q_g), I_D = 4.8 A \text{ pulsed}$

Avalanche energy

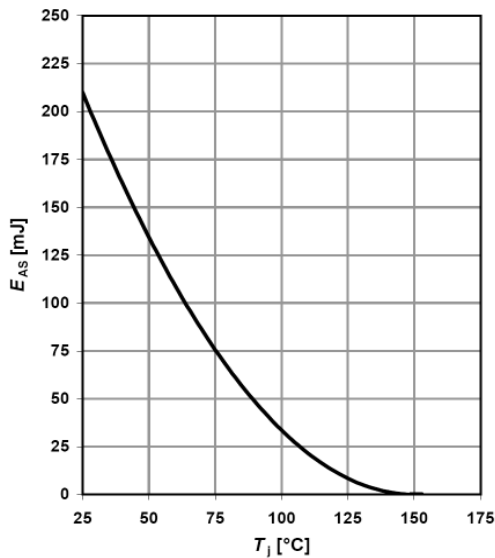

$E_{AS} = f(T_j); I_D = 1.8 A; V_{DD} = 50 V$

Drain-source breakdown voltage

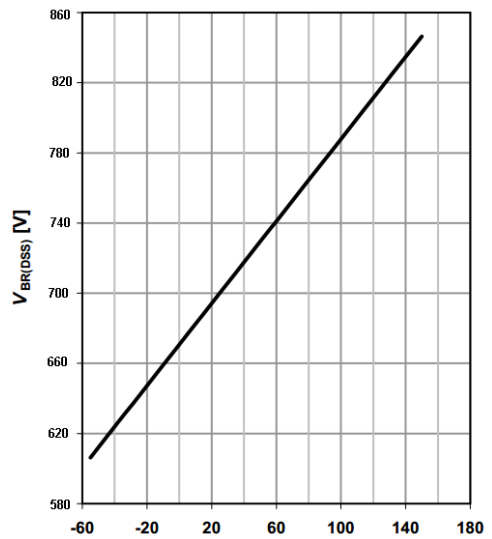

$V_{BR(DSS)} = f(T_j); I_D = 0.25 mA$

Typical Performance Characteristics

Typ. capacitances

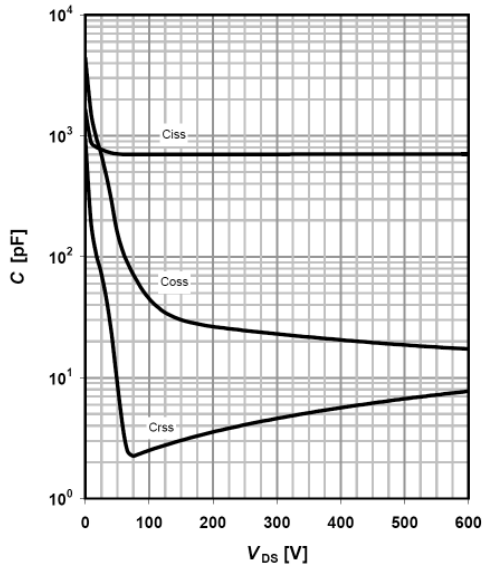

$C=f(V_{DS}); V_{GS}=0\text{ V}; f=1\text{ MHz}$

Typ. C_{oss} stored energy

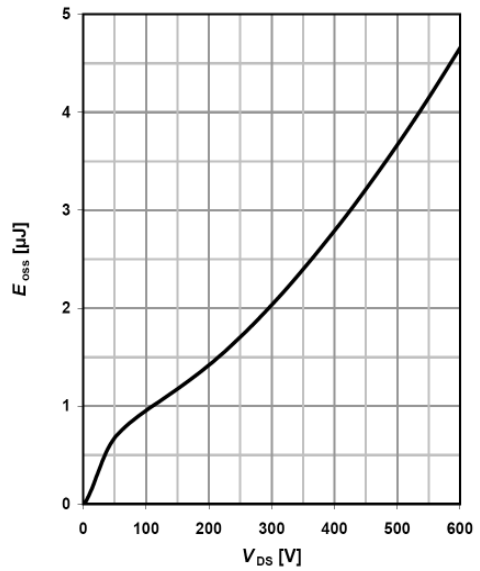

$E_{OSS}=f(V_{DS})$

Forward characteristics of reverse diode

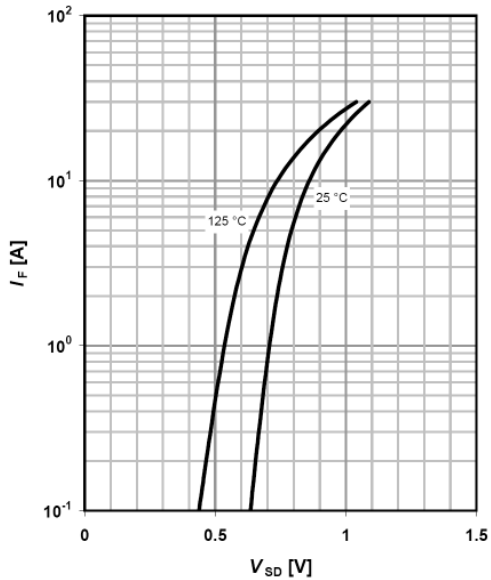

$I_F=f(V_{SD}); \text{parameter: } T_j$

Test circuits

Switching times test circuit and waveform for inductive load

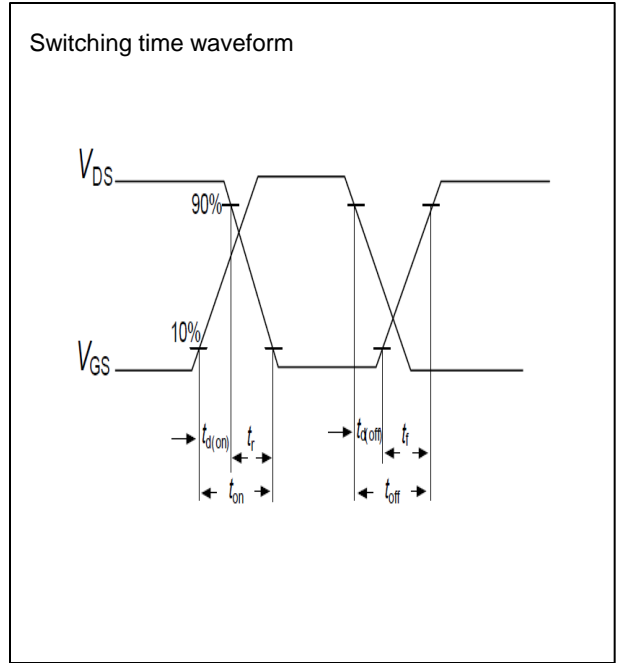
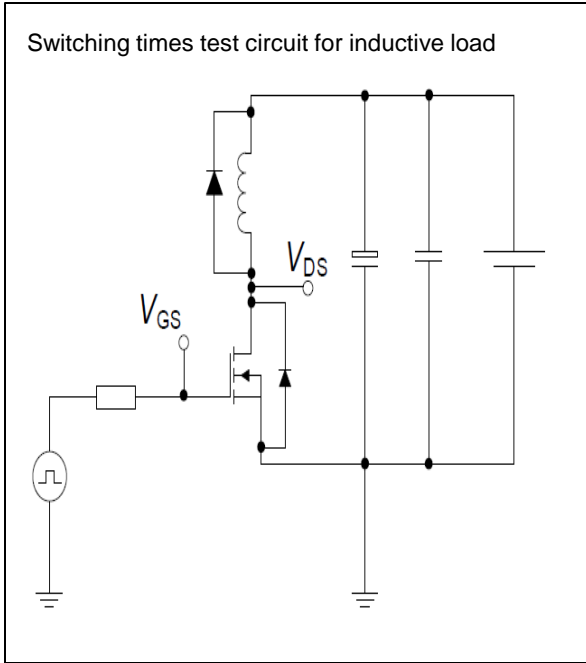

Unclamped inductive load test circuit and waveform

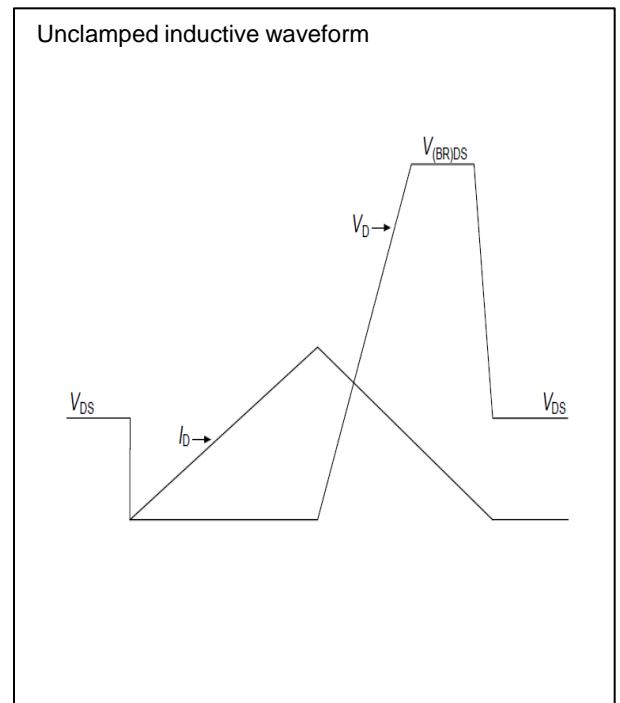
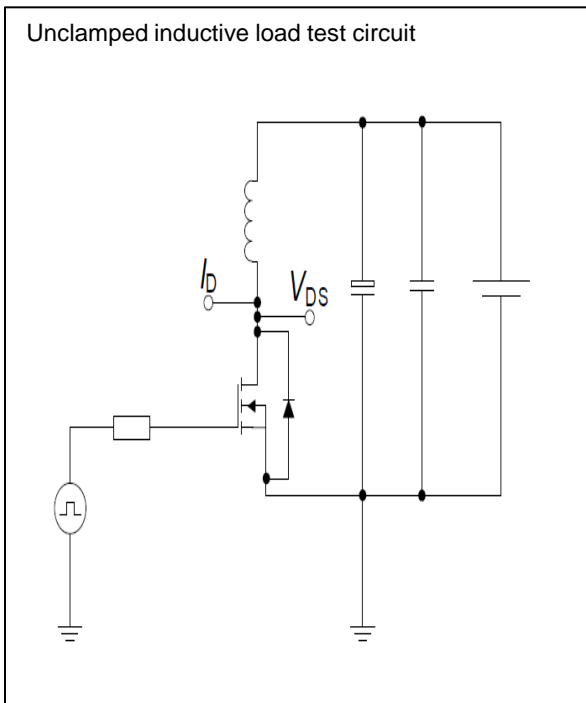

Test circuits

Test circuit and waveform for diode characteristics

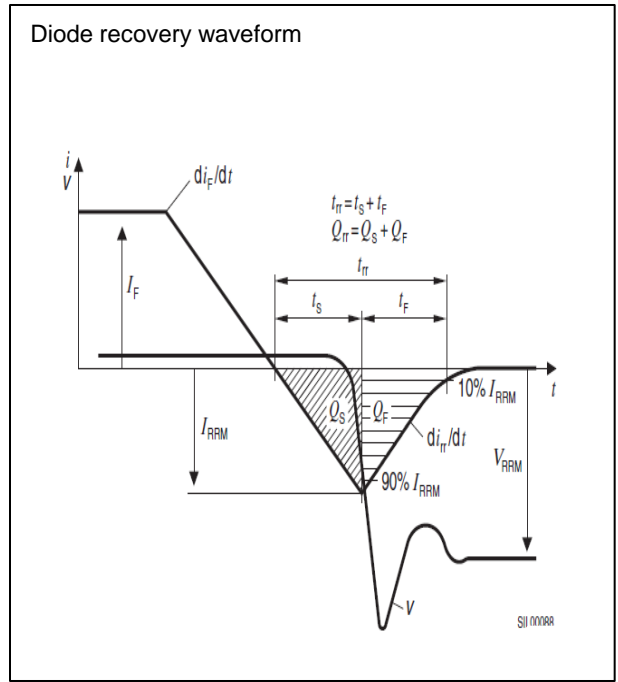
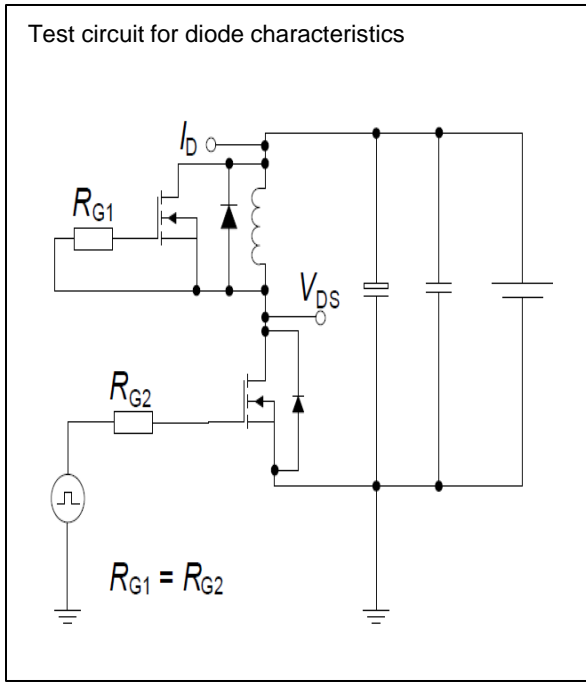

Package Outline TO-220

TSP70R450S1 700V 10.5A N-Channel SJ-MOSFET

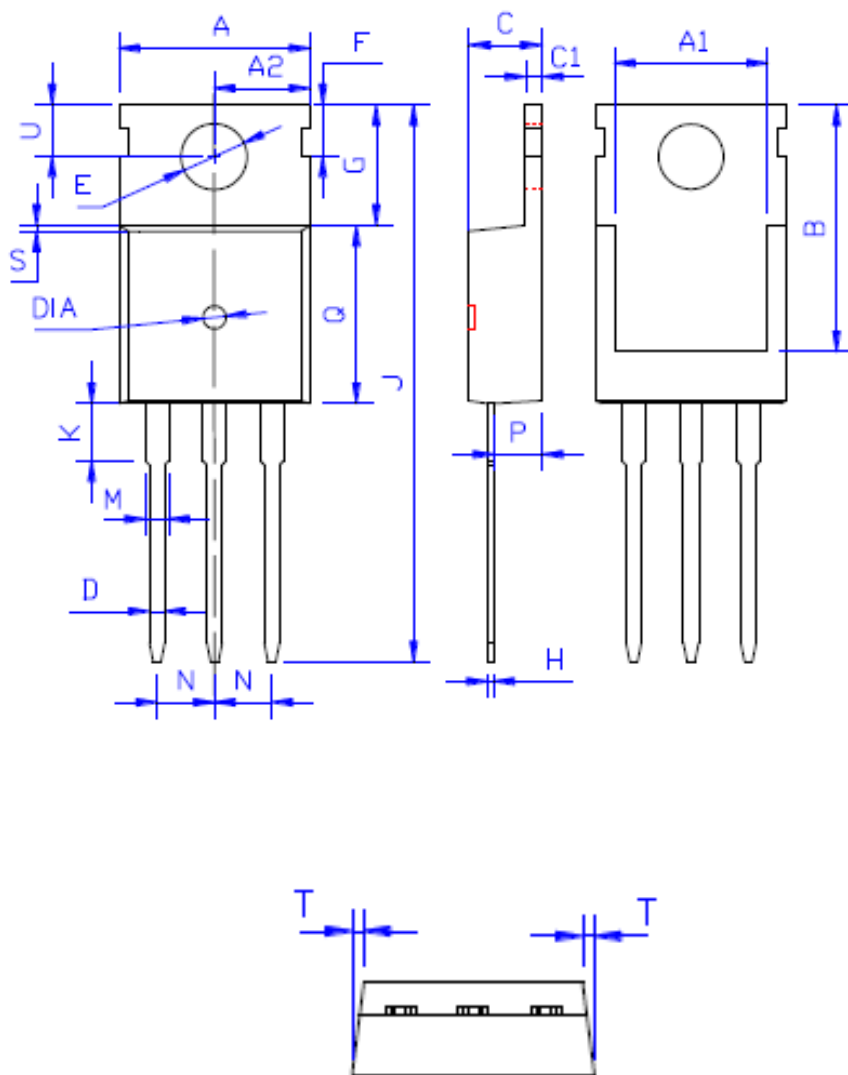

DIM	MILLIMETERS
A	10.00 ± 0.30
A1	8.00 ± 0.30
A2	5.00 ± 0.30
B	13.20 ± 0.40
C	4.50 ± 0.20
C1	1.30 ± 0.20
D	0.80 ± 0.20
E	3.60 ± 0.20
F	3.00 ± 0.30
G	6.60 ± 0.40
H	0.50 ± 0.20
J	28.88 ± 0.50
K	3.00 ± 0.30
M	1.30 ± 0.30
N	Typical 2.54
P	2.40 ± 0.40
Q	9.20 ± 0.40
S	0.25 ± 0.15
T	0.25 ± 0.15
U	2.80 ± 0.30
DIA	宽 1.50 ± 0.10 深 0.50 MAX