



TSP8N65M / TSF8N65M

650V N-Channel MOSFET

General Description

This Power MOSFET is produced using Truesemi's advanced planar stripe DMOS technology.

This advanced technology has been especially tailored to minimize on-state resistance, provide superior switching performance, and withstand high energy pulse in the avalanche and commutation mode. These devices are well suited for high efficiency switched mode power supplies, active power factor correction based on half bridge topology.

Features

- 7.5A, 650V, $R_{DS(on)} = 1.60\Omega @ V_{GS} = 10V$
- Low gate charge (typical 29nC)
- High ruggedness
- Fast switching
- 100% avalanche tested
- Improved dv/dt capability

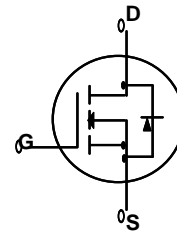
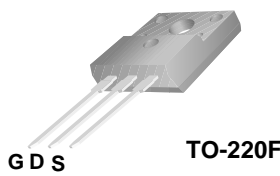
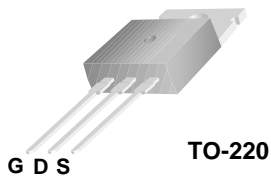

Absolute Maximum Ratings $T_C = 25^\circ\text{C}$ unless otherwise noted

Symbol	Parameter	TSP8N65M	TSF8N65M	Units
V_{DSS}	Drain-Source Voltage	650		V
I_D	Drain Current - Continuous ($T_C = 25^\circ\text{C}$) - Continuous ($T_C = 100^\circ\text{C}$)	7.5	7.5 *	A
		4.5	4.5 *	A
I_{DM}	Drain Current - Pulsed (Note 1)	30	30 *	A
V_{GSS}	Gate-Source Voltage	± 30		V
E_{AS}	Single Pulsed Avalanche Energy (Note 2)	260		mJ
E_{AR}	Repetitive Avalanche Energy (Note 1)	14.7		mJ
dv/dt	Peak Diode Recovery dv/dt (Note 3)	4.5		V/ns
P_D	Power Dissipation ($T_C = 25^\circ\text{C}$) - Derate above 25°C	147	48	W
		1.18	0.38	W/ $^\circ\text{C}$
T_J, T_{STG}	Operating and Storage Temperature Range	-55 to +150		$^\circ\text{C}$
T_L	Maximum lead temperature for soldering purposes, 1/8" from case for 5 seconds	300		$^\circ\text{C}$

* Drain current limited by maximum junction temperature.

Thermal Characteristics

Symbol	Parameter	TSP8N65M	TSF8N65M	Units
$R_{\theta JC}$	Thermal Resistance, Junction-to-Case	0.85	2.6	$^\circ\text{C}/\text{W}$
$R_{\theta CS}$	Thermal Resistance, Case-to-Sink Typ.	0.5	--	$^\circ\text{C}/\text{W}$
$R_{\theta JA}$	Thermal Resistance, Junction-to-Ambient	62.5	62.5	$^\circ\text{C}/\text{W}$



TSP8N65M / TSF8N65M

Electrical Characteristics

$T_C = 25^\circ\text{C}$ unless otherwise noted

Symbol	Parameter	Test Conditions	Min	Typ	Max	Units
Off Characteristics						
BV_{DSS}	Drain-Source Breakdown Voltage	$V_{GS} = 0\text{ V}, I_D = 250\ \mu\text{A}$	650	--	--	V
$\frac{\Delta BV_{DSS}}{\Delta T_J}$	Breakdown Voltage Temperature Coefficient	$I_D = 250\ \mu\text{A}$, Referenced to 25°C	--	0.7	--	$^\circ\text{C}^{-1}$
I_{DSS}	Zero Gate Voltage Drain Current	$V_{DS} = 650\text{ V}, V_{GS} = 0\text{ V}$	--	--	1	μA
		$V_{DS} = 520\text{ V}, T_C = 125^\circ\text{C}$	--	--	10	μA
I_{GSSF}	Gate-Body Leakage Current, Forward	$V_{GS} = 30\text{ V}, V_{DS} = 0\text{ V}$	--	--	100	nA
I_{GSSR}	Gate-Body Leakage Current, Reverse	$V_{GS} = -30\text{ V}, V_{DS} = 0\text{ V}$	--	--	-100	nA

On Characteristics

$V_{GS(th)}$	Gate Threshold Voltage	$V_{DS} = V_{GS}, I_D = 250\ \mu\text{A}$	2.0	--	4.5	V
$R_{DS(on)}$	Static Drain-Source On-Resistance	$V_{GS} = 10\text{ V}, I_D = 3.75\text{ A}$	--	1.2	1.6	Ω

Dynamic Characteristics

C_{iss}	Input Capacitance	$V_{DS} = 25\text{ V}, V_{GS} = 0\text{ V},$ $f = 1.0\text{ MHz}$	--	1000	--	pF
C_{oss}	Output Capacitance		--	110	--	pF
C_{rss}	Reverse Transfer Capacitance		--	12.6	--	pF

Switching Characteristics

$t_{d(on)}$	Turn-On Delay Time	$V_{DD} = 325\text{ V}, I_D = 7.5\text{ A},$ $R_G = 25\ \Omega$	--	20	--	ns	
t_r	Turn-On Rise Time		--	50	--	ns	
$t_{d(off)}$	Turn-Off Delay Time		(Note 4, 5)	--	80	--	ns
t_f	Turn-Off Fall Time		(Note 4, 5)	--	70	--	ns
Q_g	Total Gate Charge	$V_{DS} = 520\text{ V}, I_D = 7.5\text{ A},$ $V_{GS} = 10\text{ V}$	--	29	-	nC	
Q_{gs}	Gate-Source Charge		(Note 4, 5)	--	4.7	--	nC
Q_{gd}	Gate-Drain Charge		(Note 4, 5)	--	12.5	--	nC

Drain-Source Diode Characteristics and Maximum Ratings

I_S	Maximum Continuous Drain-Source Diode Forward Current	--	--	7.5	A	
I_{SM}	Maximum Pulsed Drain-Source Diode Forward Current	--	--	30	A	
V_{SD}	Drain-Source Diode Forward Voltage	$V_{GS} = 0\text{ V}, I_S = 7.5\text{ A}$	--	--	1.4	V
t_{rr}	Reverse Recovery Time	$V_{GS} = 0\text{ V}, I_S = 7.5\text{ A},$ $di_F / dt = 100\text{ A}/\mu\text{s}$	--	350	--	ns
Q_{rr}	Reverse Recovery Charge		(Note 4)	--	3.3	--

Notes:

1. Repetitive Rating : Pulse width limited by maximum junction temperature
2. $L = 10\text{ mH}, I_{AS} = 7.5\text{ A}, V_{DD} = 50\text{ V}, R_G = 25\ \Omega$, Starting $T_J = 25^\circ\text{C}$
3. $I_{SD} \leq 7.5\text{ A}, di/dt \leq 200\text{ A}/\mu\text{s}, V_{DD} \leq BV_{DSS}$, Starting $T_J = 25^\circ\text{C}$
4. Pulse Test : Pulse width $\leq 300\ \mu\text{s}$, Duty cycle $\leq 2\%$
5. Essentially independent of operating temperature



Typical Characteristics

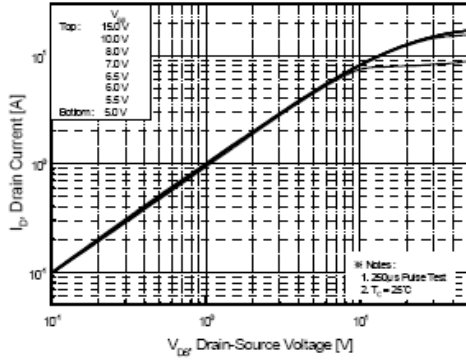

Figure 1. On-Region Characteristics

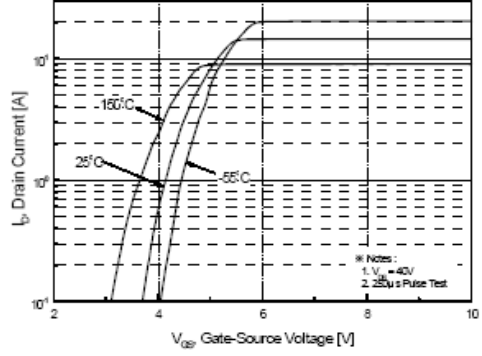

Figure 2. Transfer Characteristics

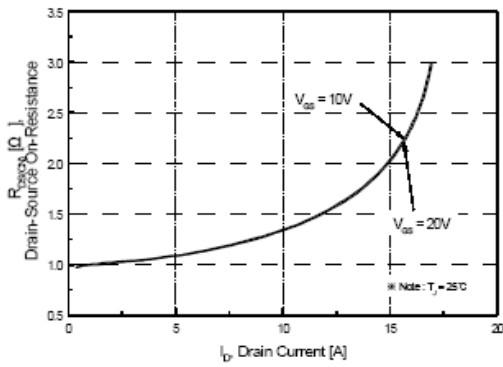

Figure 3. On-Resistance Variation vs Drain Current and Gate Voltage

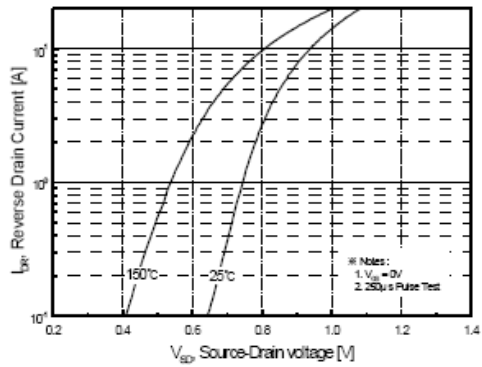

Figure 4. Body Diode Forward Voltage Variation with Source Current and Temperature

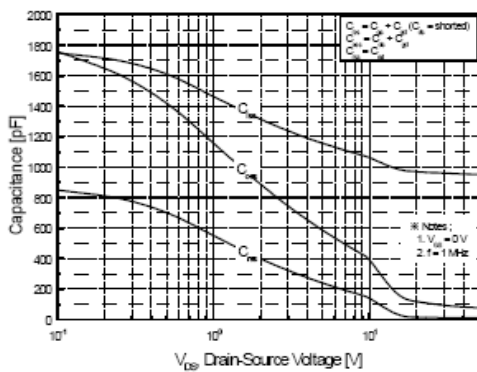

Figure 5. Capacitance Characteristics

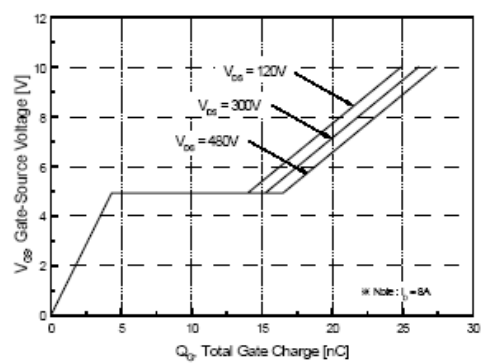

Figure 6. Gate Charge Characteristics



Typical Characteristics (Continued)

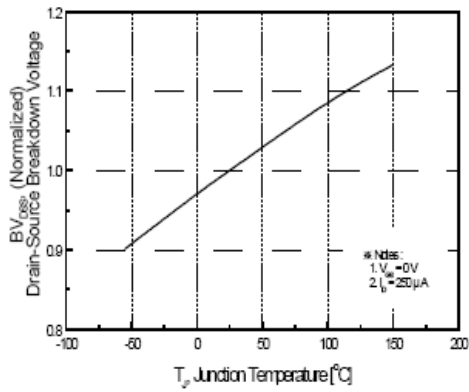

Figure 7. Breakdown Voltage Variation vs Temperature

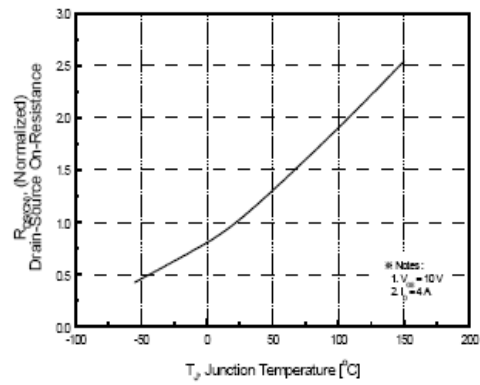

Figure 8. On-Resistance Variation vs Temperature

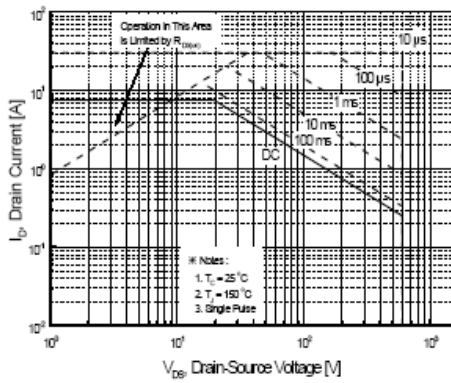

Figure 9-1. Maximum Safe Operating Area for TSP8N65M

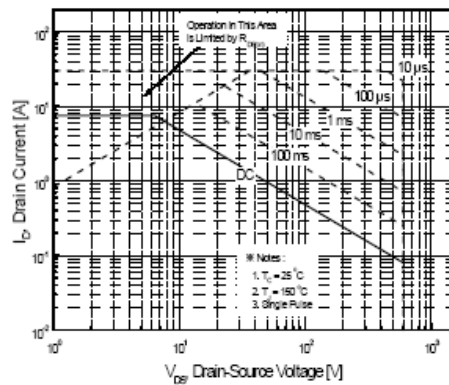

Figure 9-2. Maximum Safe Operating Area for TSF8N65M

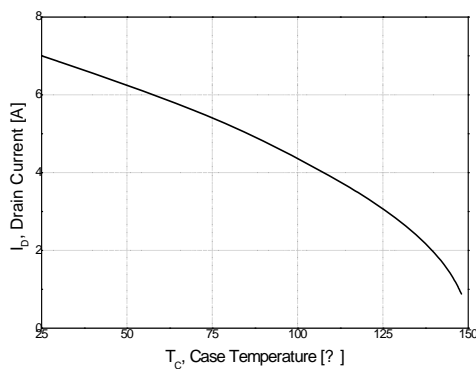

Figure 10. Maximum Drain Current vs Case Temperature



Typical Characteristics (Continued)

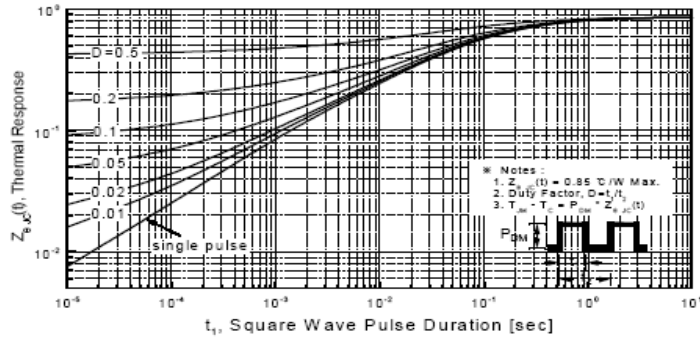

Figure 11-1. Transient Thermal Response Curve for TSP8N65M

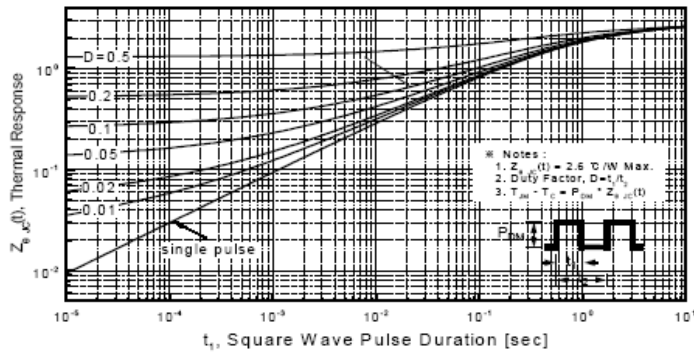
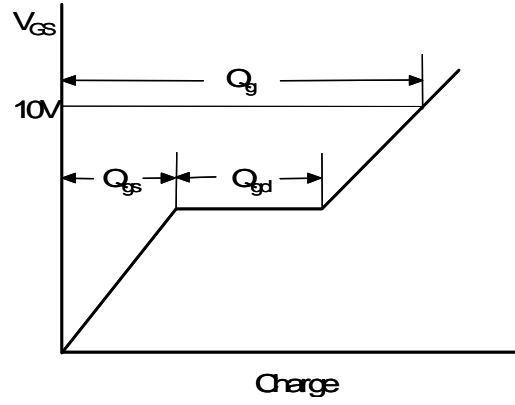
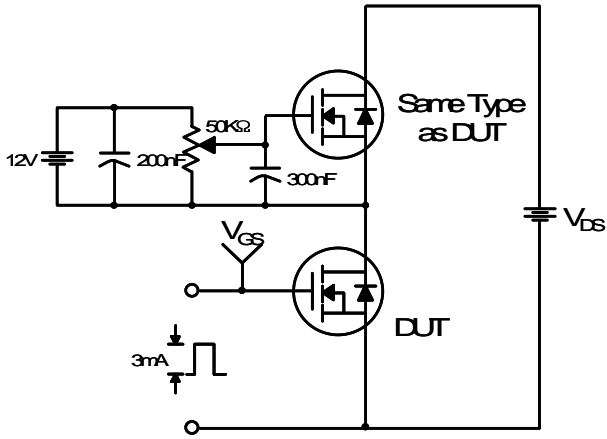

Figure 11-2. Transient Thermal Response Curve for TSF8N65M



Gate Charge Test Circuit & Waveform



Resistive Switching Test Circuit & Waveforms

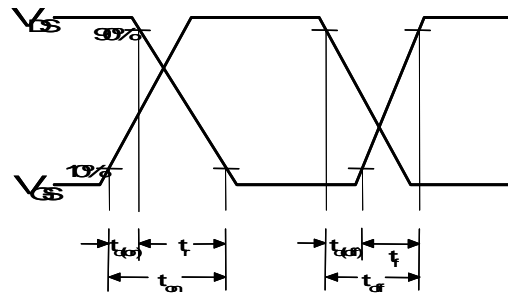
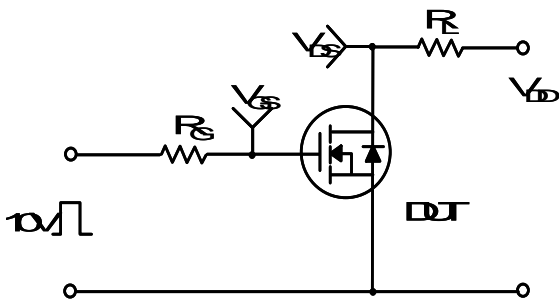

Unclamped Inductive Switching Test Circuit & Waveforms

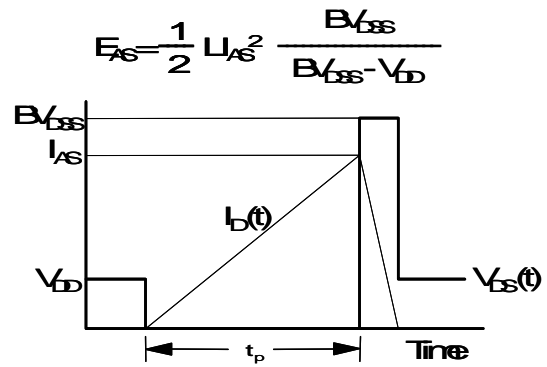
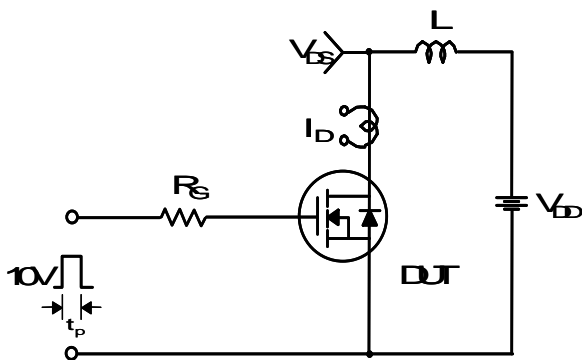

Peak Diode Recovery dv/dt Test Circuit & Waveforms

