

Premium PLCs TSXRKY/TSXPSY

Racks/Power Supplies

www.DataSheet4U.com

Quick Reference Guide

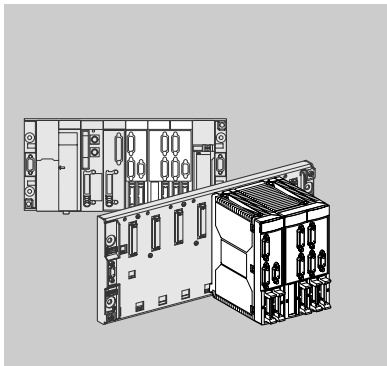

Merlin Gerin

Modicon

Square D

Telemecanique

www.DataSheet4U.com

www.DataSheet4U.com

General safety advice for users	2
TSX RKY .. standard racks and TSX RKY ..EX extendable racks	4
Presentation	4
Physical description	5
Dimensions	6
Mounting/Fixing	6
Installation rules	7
Addressing racks in a PLC station	8
Module addresses	10
Installing modules	11
Mounting modules and terminal blocks	13
Composition of a PLC station with a TSX/PMX 57 processor	14
Composition of a PLC station with a PCX 57 processor	16
Bus X extension cables	18
TSX TLYEX line terminator	19
Protective cover for unoccupied position	21
Labelling	21
TSX PSY... power supply modules	23
Presentation	23
Catalog	23
Physical description	24
Auxiliary functions	25
Installation/Mounting	26
Characteristics	27
Connection rules	31
Connections	32
Grounding the racks	32
Connecting the power supplies	32
Alarm relay connections	35

1 General

This manual is intended for personnel technically qualified to install, operate and maintain the products which are described herein. For advanced use of these products please contact your nearest sales office for additional information.

The contents of this manual are not contractual and cannot under any circumstance extend or restrict contract warranty clauses.

2 Qualification of personnel

Only **qualified personnel** are authorized to install, operate or maintain the products. Any work performed by an unqualified person or non-observance of the safety instructions contained in this document or attached to the equipment may jeopardize the safety of personnel and/or cause irreparable damage to equipment.

3 Warnings

Warnings serve to prevent specific risks encountered by personnel and/or equipment. They are indicated in the documentation and on the products by different warning symbols.

Caution

Indicates that not following instructions or ignoring the warning may cause serious personal injury, death and/or serious damage to equipment.

Important or ⚠

Indicates that not following a specific instruction may lead to minor injury and/or damage to equipment.

Comment

Highlights important information relating to the product, its operation or its accompanying documentation.

4 Conformity of use

The products described in this manual **conform to the European Directives (*)** to which they are subject (CE marking). However, they can only be used correctly in the context of the applications for which they are intended (described in the various documents) and when connected to approved third party products.

(*) EMC and LV Directives, concerning Electromagnetic Compatibility and Low Voltage.

5 Installing and setting up equipment

It is important to observe the following rules when installing and starting up equipment. In addition, if the installation includes digital links, it is essential to follow the basic wiring rules, given in the manual "Electromagnetic Compatibility of Industrial Networks and Fieldbuses", **reference TSX DG KBLE**.

- Safety instructions must be followed meticulously. These instructions are in the documentation or on the equipment being installed and set up.
- The type of equipment defines the way in which it should be installed :
 - A flush-mountable device (for example, a process control terminal) must be flush-mounted
 - A device which is to be built in (for example, a PLC) must be placed in a cabinet or enclosure
 - The casing of a laptop or portable device (for example, a programming terminal or a notebook) must remain closed

- If the device is permanently connected, its electrical installation must include a device to isolate it from the power supply and a circuit-breaker to protect it against overcurrents and isolation faults. If this is not the case, the power socket must be grounded and be easily accessed. **The device must be connected to the protective ground.**
- If the device is supplied with 24 or 48 VDC, the low voltage circuits must be protected. Only use power supplies which conform to the standards currently in force.
- Check that the supply voltages remain within the tolerance ranges defined in the technical characteristics of the devices.
- All measures must be taken to ensure that any power return (immediate, warm or cold) does not lead to a dangerous state which may place personnel or the installation at risk.
- Emergency stop devices must remain effective in all the device's operating mods, even those which are abnormal (for example, when a wire becomes disconnected). Resetting these devices must not cause uncontrolled or improper restarts.
- Cables which carry signals must be located where they do not cause interference with the control system functions by capacitive, inductive or electromagnetic interference.
- Control system equipment and their control devices must be installed in such a way as to ensure that they are protected against unintentional operation.
- Appropriate safety measures must be taken for the inputs and outputs, to prevent improper states in the control system device, if no signal is received.

6 Equipment operation

The operational safety and availability of a device is its ability to avoid the appearance of faults and to minimize their effects if they occur.

A fault inside the control system is known as :

- passive, if it results in an open output circuit (no command is sent to the actuators).
- active, if it results in a closed output circuit (a command is sent to the actuators).

From the safety point of view, a given fault is dangerous or not depending on the type of command given during normal operation. A passive fault is dangerous if the normal command is the operation of an alarm. An active fault is dangerous if it maintains or activates an undesirable command.

The system designer must **use devices external to the PLC** to protect against active faults inside the PLC, whether they are indicated or not.

7 Electrical and thermal characteristics

Details of the electrical and thermal characteristics of devices are given in the associated technical documents (installation manuals, service instructions).

8 Maintenance

Troubleshooting procedure

- Control system equipment should only be repaired by qualified personnel (after sales service engineer, or technician approved by Schneider Automation). Only certified replacement parts or components should be used.
- Before performing any operation on equipment, always disconnect the power supply and mechanically lock any moving parts.

Replacement and recycling of used batteries

Use batteries of the same type as the original. **www.DataSheet4U.com**
Use old batteries in a safe way. Do not mix old and new batteries. Do not throw them in the same way as toxic waste.

Presentation

TSX RKY .. racks provide the following functions :

- mechanical functions : they are used for fitting all PLC station modules (power supply, processor, discrete I/O, etc) and can be fitted in enclosures, on the machine frame or on panels,
- electrical functions : they have an integral bus, called Bus X which distributes the power supplies required for each module in the same rack and the service signals and data for the whole PLC station if it comprises a number of racks.

2 families of racks (standard and extendable) are available in several modularities (4, 6, 8, 12 positions) :

- Standard racks : these are used to make up a PLC station limited to a **single rack**.
- Extendable racks : these are used to make up a PLC station which can contain :
 - **A maximum of 8 TSXRKY 12EX racks.**
 - **A maximum of 16 TSX 4EX/6EX/8EX racks.**

These racks are distributed on a bus called Bus X whose maximum length must not exceed 100 meters. Bus X continuity from one rack to another is provided by a bus extension cable with special characteristics.

Standard racks

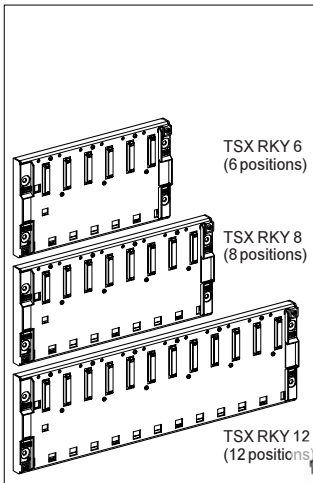

Extendable racks

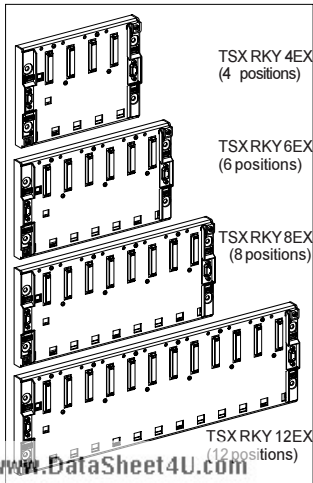

Physical description

The rack shown below is a TSX RKY 8EX extendable rack. Standard racks do not comprise micro-switches (label 10) and 9-pin SUB D connectors (label 11).

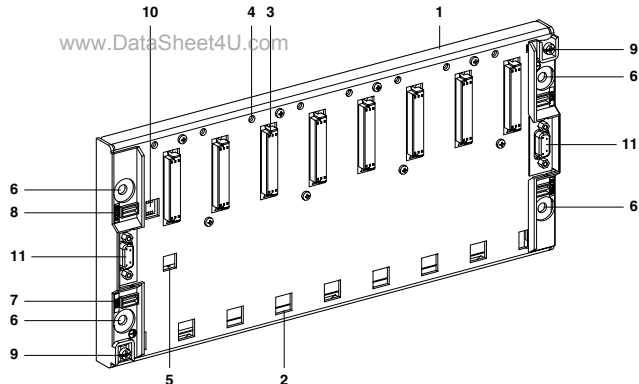

- 1 Metal plate acting as support for the Bus X electronic card and protection for the bus against EMI/ESD interference, module support and mechanical reinforcement for the rack.
- 2 Apertures for anchoring the module pins.
- 3 48-pin female 1/2 DIN connectors for connecting the rack to the modules. They are protected by covers which should be removed before the modules are installed. The connector located furthest to the left and marked PS is always dedicated to the rack power supply module; the other connectors marked 00 to .. can take all the other type of modules.
- 4 Tapped holes for the module fixing screw.
- 5 Aperture which ensures correct location when a power supply module is fitted which cannot be mounted in any other position.
- 6 Holes for M6 screw for fitting the rack on a support.
- 7 Location for marking the rack address.
- 8 Location for marking the station network address.
- 9 Ground terminals for grounding the rack.
- 10 Micro-switches for coding the rack address. These micro-switches are only present on TSX RKY 4EX/6EX/8EX/12EX extendable racks.
- 11 9-pin female SUB D connectors for locating Bus X remotely on another rack. These connectors are only present on TSX RKY 6EX/6EX/8E/X12EX extendable racks.

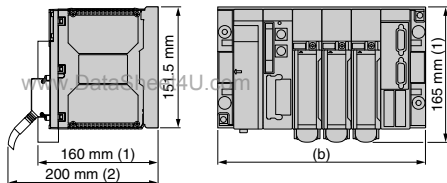
Dimensions

- (1) modules with screw terminal blocks
 (2) maximum depth with all types of module and associated connections

Rack references	(b) in mm
TSX RKY 4EX	187.9 mm
TSX RKY 6/6EX	261.6 mm
TSX RKY 8/8EX	335.3 mm
TSX RKY 12/12EX	482.6 mm

Mounting / Fixing
• Mounting on a 35 mm wide DIN rail

Fix with 4 M6x25 screws + washers and AF1-CF56 1/4 turn sliding nuts

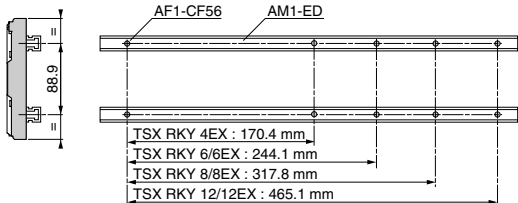
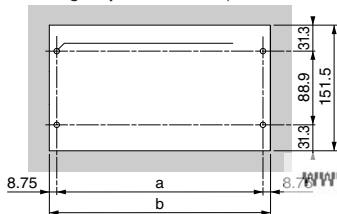

• Mounting on panel : cut-out (dimensions in mm)

Rack references	a	b
TSX RKY 4EX	170.4	187.9
TSX RKY 6/6EX	244.1	261.6
TSX RKY 8/8EX	317.8	335.3
TSX RKY 12/12EX	465.1	482.6

a and b dimensions in millimeters

Mounting / fixing (cont'd)

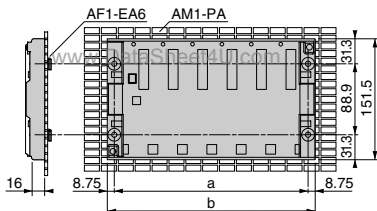
- Mounting on AM1-PA Telequick perforated mounting plate



Fix the rack with 4 M6x25 screws + washer and AF1-EA6 clip nuts.

(a and b dimensions : see table on previous page).

- Tightening torque for fixing screws : 2.0 N.m maximum

Installation rules

TSX RKY ... racks must be installed horizontally and on a vertical plane.

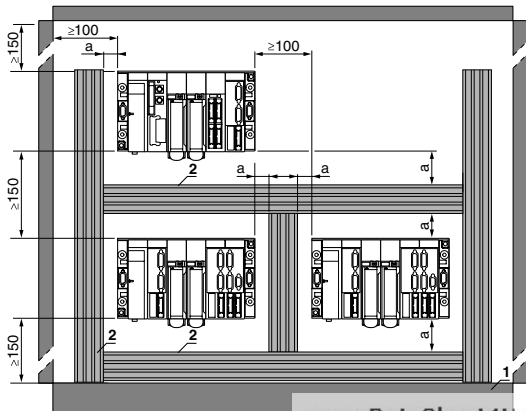

$a \geq 50$ mm

1 housing or enclosure

2 cable duct or clip

Addressing racks in a PLC station

- Station made up of a standard rack
A station is always limited to a single rack and the rack address is therefore implicit and always has the value 0.

- Station made up of extendable racks

For each station rack, 4 micro-switches located on the rack are used to :

- code the rack address on Bus X (0 to 7) : micro-switches 1 to 3.
- code 2 racks (4, 6 or 8 slots) at the same address : micro-switch 4.

This function is only managed by PL7 Junior and PL7 Pro software versions V ≥ 3.3.
The different addresses must be coded before installing the power supply module.

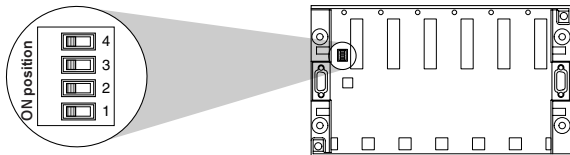

Rack addresses	00	01	02	03	04	05	06	07
4								
3								
2								
1								
	ON OFF	ON OFF	ON OFF	ON OFF	ON OFF	ON OFF	ON OFF	ON OFF

Assigning addresses to the various racks :

- Address 0 : This address is always assigned to the rack which supports :
 - the TSX / PMX 57 processor physically
 - the PCX 57 processor virtually
 This rack can be in any position in the chain.
- Addresses 1 to 7 : These can be assigned to all the other station racks, in any order.

⚠ If, accidentally, two or more racks are unintentionally positioned at the same address (other than address 0), the racks concerned go into fault mode, as do their modules.
After correcting any addressing errors, it is necessary to switch the power supply for those racks on/off.

Notes : 1 This note only concerns rack with the reference TSX RKY ●●EX.

2 If two or more racks are at address 0, the rack supporting the processor does not go into fault mode.

Principle of addressing 2 racks at the same address (see diagram opposite).

This function is only managed by PL7 Junior and PL7 Pro software versions V ≥ 3.3.

- TSX RKY 12EX racks cannot receive a second rack at the same address.
- TSX RKY 4EX/6EX/8EX racks can be mixed together.
- Two TSX RKY 4EX/6EX/8EX racks at the same address are not necessarily daisy-chained from one to the next; the physical distribution is of no importance.

TSX RKY 12EX Sheet4U.com

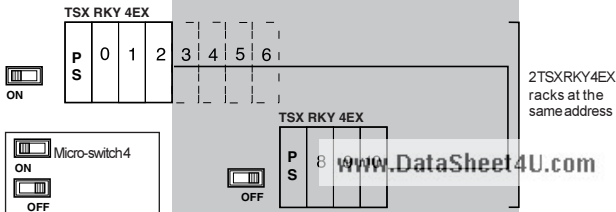
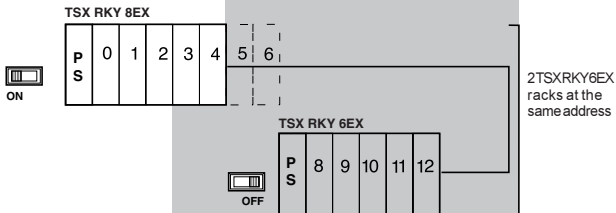
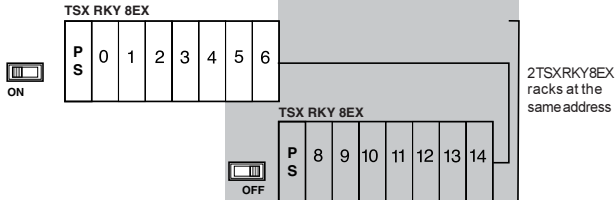
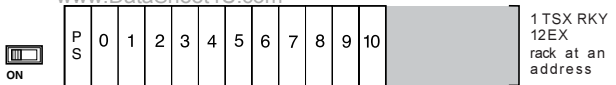

Module addresses

A module address is geographical and will depend on the position of the module in the rack. The address of each position is indicated below each connector. The connector marked PS is always dedicated to the power supply.

Module addresses as a function of the type of rack

• Standard racks

- TSX RKY 6 racks : addresses 00 to 04
- TSX RKY 8 racks : addresses 00 to 06
- TSX RKY 12 racks : addresses 00 to 10

• Extendable racks

The address of a module depends on the position of micro-switch 4 (see table below).

Type of rack	Module addresses	
	micro-switch 4 in ON position	micro-switch 4 in OFF position
TSX RKY 4EX rack	00 to 02	08 to 10
TSX RKY 6EX rack	00 to 04	08 to 12
TSX RKY 8EX rack	00 to 06	08 to 14
TSX RKY 12EX rack	00 to 10	unusable

Module addresses

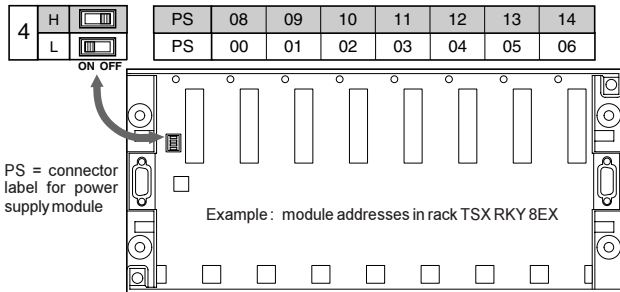

Note : addresses in gray are only currently available with PL7 Junior and PL7 Pro software versions V ≥ 3.3.

Installing modules

- **On standard or extendable racks with address 0 and TSX / PMX 57 processor**
The rack with address 0 must receive a power supply module and the processor module. Premium PLCs have two types of power supply (standard format or double format), the position of the processor depends on the type of power supply used.

Using a standard format power supply module :

- The power supply module always occupies position PS.
- The standard format processor module can be installed in position 00 (preferred position) or in position 01 (if position 00 is unavailable).
- The double format processor module is installed in positions 00 and 01 (preferred position) or in positions 01 and 02 (if position 00 is unavailable).
- The other modules are installed starting at positions 01, 02 or 03 depending on the installation of the processor.

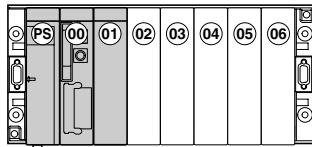
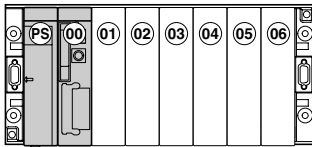

Using a double format power supply module :

- The power supply module always occupies positions PS and 00.
- The standard format processor module must be installed in position 01.
- The double format processor module is installed in positions 01 and 02.
- The other modules are installed starting at positions 02 or 03 depending on the type of processor (standard format or double format).

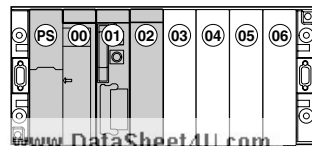
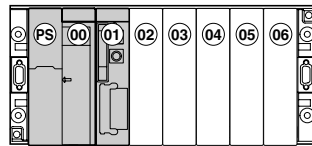

- On extendable racks with address 0 and PCX 57 processor which can be integrated on a PC

The PCX 57 processor, integrated in the PC, occupies a position "in virtual" on the rack with address 0; this virtual position will be unoccupied. Premium PLCs have two types of power supply (standard format or double format), the position of the processor depends on the type of power supply used.

Using a standard format power supply module :

- The power supply module always occupies position PS.
- Position 00, virtual slot for the processor, must be unoccupied.
- The other modules are installed starting at position 01.

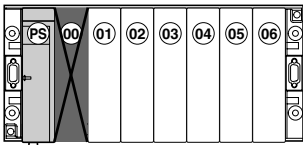

Using a double format power supply module :

- The power supply module always occupies positions PS and 00.
- Position 00, virtual slot for the processor, must be unoccupied.
- The other modules are installed starting at position 02.

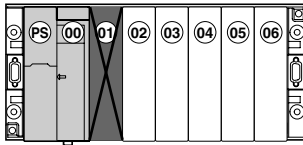

On extendable rack with address 1 to 7

Each rack must have a standard or double format power supply module.

Using a standard format power supply module :

- The power supply module always occupies position PS.
- The other modules are installed starting at position 00.

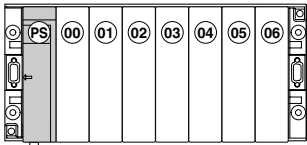

Using a double format power supply module :

- The power supply module always occupies positions PS and 00.
- The other modules are installed starting at position 01.

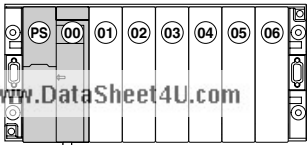

Mounting modules and terminal blocks

Modules can be inserted and removed while powered up with the exception of power supply modules, the processor and PCMCIA communication cards.

⚠ Insertion/removal of a powered-up module must be performed by screwing or unscrewing the module manually, with the terminal block or HE10 connector disconnected and the sensor/actuator power supply cut if this is greater than 48V.

• Mounting modules with screw terminal blocks

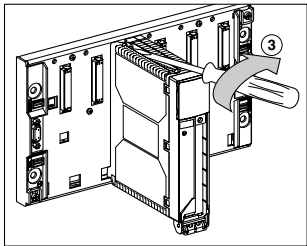
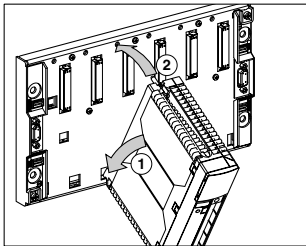

• Fitting a screw terminal block on a module

The first time a screw terminal block is mounted on a module the terminal block has to be coded with the type of module on which it is mounted. This is done by transferring 2 coding devices from the module onto the screw terminal block. This mechanical code prohibits any subsequent mounting of the terminal block with this code on any other type of module.

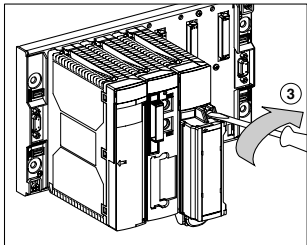
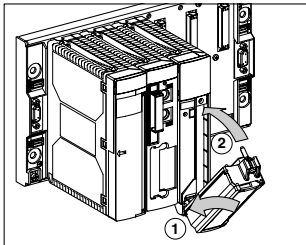

Note : When replacing a module already in position on the rack with another module, the screw terminal block on the old module already has coding devices which relate to the module. Two things may happen :

- **Module failure, to be replaced by a module of the same type** : so that the screw terminal block can be installed on the new module, the coding devices on the old module must be removed before the screw terminal block can be fitted.

- **Replacing a module with another type of module** : first remove the old coding devices on the screw terminal block before continuing with the mounting procedure described above.

Composition of a PLC station with a TSX/PMX 57 processor

- Based on TSX RKY 6/8/12 standard racks
Standard racks are used to make up a PLC station limited to a **single rack**.
- Based on TSX RKY 4EX/6EX/8EX/12EX extendable racks

Extendable racks enable a PLC station to comprise the following :

TSX/PMX 57 10 station :

- A maximum of 2 TSX RKY 12EX racks.
- A maximum of 4 TSX RKY 4EX/6EX/8EX racks.

TSX/PMX 57 20/57 30/57 40 station :

- A maximum of 8 TSX RKY 12EX racks.
- A maximum of 16 TSX RKY 4EX/6EX/8EX racks.

The same station may comprise 4, 6, 8 and 12 slot racks which are interconnected by Bus X extension cables (label 1). Bus X must be fitted with a line terminator at each end (label 2).

- Bus X extension cables

Connections between racks are made by TSX CBY ..0K cables which are connected to the 9-pin SUB D connector located to the left and right of each extendable rack.

As there is no notion of entry and exit on 9-pin SUB D connectors, cables can come from one rack or go to another rack irrespective of whether connecting from the right or left.

- Line termination

The two extendable racks at each end of the Bus X must have a TSX TLYEX line terminator labelled A/ and /B fitted on the unused connector.

- Maximum length of cables

The cumulative length of all the TSX CBY ..0K cables used in a PLC station must never exceed 100 meters.

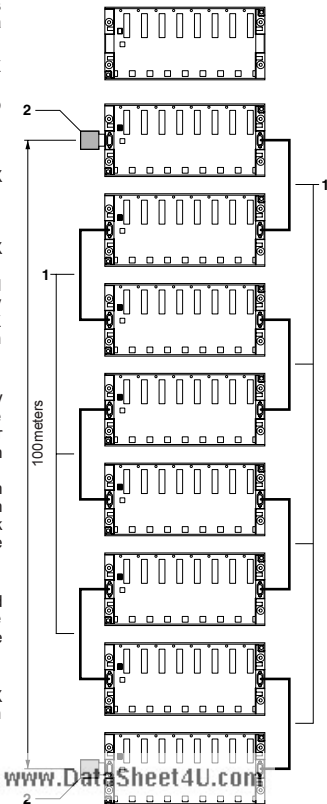

If a TSX/PMX 57 PLC station requires distances between racks which are greater than 100 meters, a Bus X remote rackmaster module (TSX REY 200) is used to locate two Bus X segments at a maximum distance of 250 meters away from the rack supporting the processor. The maximum length of each Bus X segment is 100 meters.

The maximum number of racks in the station is the same as for a station without a rackmaster module:

- TSX/PM 57 10 station :
 - 2 TSX RKY 12EX racks.
 - 4 TSX RKY 4EX/6EX/8EX racks.
- TSX/PMX 57 20/57 30/57 40 station :
 - 8 TSX RKY 12EX racks.
 - 16 TSX RKY 4EX/6EX/8EX racks.

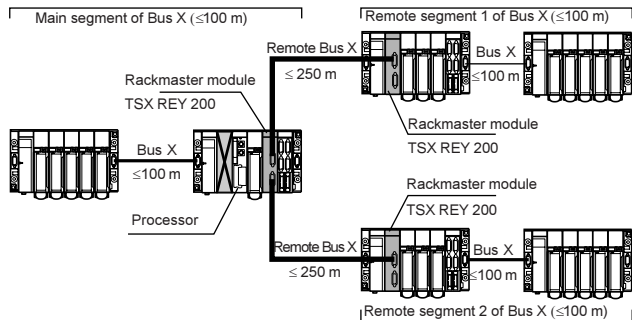

Installation of a Bus X rackmaster is described in the installation guide supplied with the TSX REY 200 module.

Terminology

- TSX 57 10 station : station fitted with a TSX P57 10•/15• processor
- TSX 57 20 station : station fitted with a TSX P57 20•/25•/2•23 processor
- TSX 57 30 station : station fitted with a TSX P57 30•/35•/3623 processor
- TSX 57 40 station : station fitted with a TSX P57 402/45•/4823 processor
- PMX 57 10 station : station fitted with a TPMX P57 102 processor
- PMX 57 20 station : station fitted with a TPMX P57 202 processor
- PMX 57 30 station : station fitted with a TPMX P57 302 processor
- PMX 57 40 station : station fitted with a TPMX P57 452 processor

Composition of a PLC station with a PCX 57 processor

In this case, the PLC station is made up of TSX RKY 4EX/6EX/8EX/12EX extendable racks.

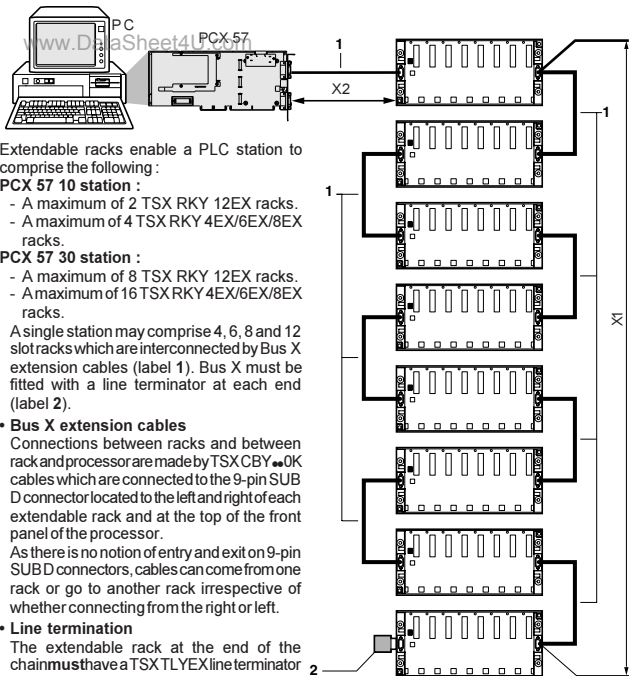

Extendable racks enable a PLC station to comprise the following :

PCX 57 10 station :

- A maximum of 2 TSX RKY 12EX racks.
- A maximum of 4 TSX RKY 4EX/6EX/8EX racks.

PCX 57 30 station :

- A maximum of 8 TSX RKY 12EX racks.
- A maximum of 16 TSX RKY 4EX/6EX/8EX racks.

A single station may comprise 4, 6, 8 and 12 slot racks which are interconnected by Bus X extension cables (label 1). Bus X must be fitted with a line terminator at each end (label 2).

• Bus X extension cables

Connections between racks and between rack and processor are made by TSX CBY..0K cables which are connected to the 9-pin SUB D connector located to the left and right of each extendable rack and at the top of the front panel of the processor.

As there is no notion of entry and exit on 9-pin SUB D connectors, cables can come from one rack or go to another rack irrespective of whether connecting from the right or left.

• Line termination

The extendable rack at the end of the chain must have a TSX TLYEX line terminator labelled /B on the unused connector.

The PCX 57 processor was originally designed to be at the head of the line. The equivalent of line terminator /A is therefore integrated in it.

- **Maximum cable length :** The cumulative length of all TSX CBY..0K cables used in a PLC station must never exceed 100 meters.

If a PCX 57 PLC station requires distances between racks which are greater than 100 meters, a Bus X remote rackmaster module (TSX REY 200) is used to locate two Bus X segments at a maximum distance of 250 meters away from the rack virtually supporting the processor. The maximum length of each Bus X segment is 100 meters.

The maximum number of racks in the station is the same as for a station without a rackmaster module www.DataSheet4U.com

- PCX 57 10 station :
 - 2 TSXRKY 12EX racks.
 - 4 TSXRKY 4EX/6EX/8EX racks.
- PCX 57 30 station :
 - 8 TSXRKY 12EX racks.
 - 16 TSXRKY 4EX/6EX/8EX racks.

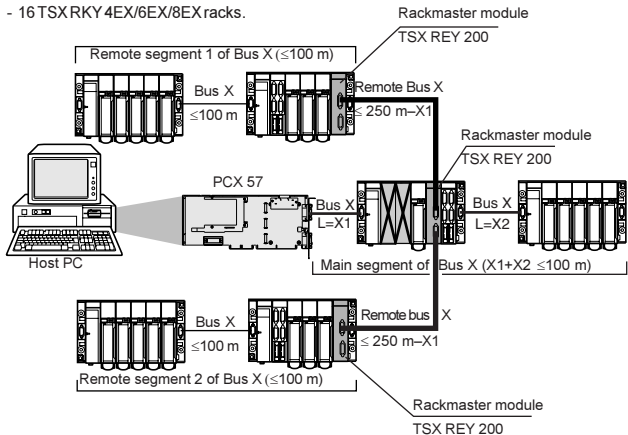

Installation of a Bus X rackmaster is described in the installation guide supplied with the TSX REY 200 module.

Terminology

- PCX 57 10 station : station fitted with a TPCX 57 1012 processor
- TSX 57 30 station : station fitted with a TPCX 57 3512 processor

Bus X extension cables
• Bus X extension cables : TSX CBY ..0K (ii ≥ 02)

These cables, of a set length, enable the TSX RKY..EX expandable racks to be daisy-chained together. When a PCX 57 processor is used, they can also be used to make the connection between the processor integrated in the PC and the first rack in the station. They are fitted at each end with a 9-pin SUB D connector.

Note : these cables do not carry the power supply, each rack has its own power supply.

References	Length
TSX CBY 010K (ii ≥ 02)	1 meter
TSX CBY 030K (ii ≥ 02)	3 meters
TSX CBY 050K (ii ≥ 02)	5 meters
TSX CBY 120K (ii ≥ 02)	12 meters
TSX CBY 180K (ii ≥ 02)	18 meters
TSX CBY 280K (ii ≥ 02)	28 meters
TSX CBY 380K (ii ≥ 02)	38 meters
TSX CBY 500K (ii ≥ 02)	50 meters
TSX CBY 720K (ii ≥ 02)	72 meters
TSX CBY 1000K (ii ≥ 02)	100 meters

Station with TSX/PMX 57 processor

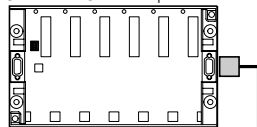

TSX CBY ..0K

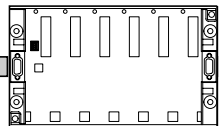

TSX CBY ..0K

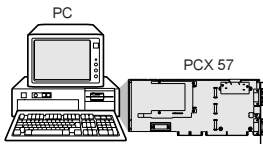
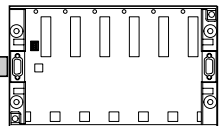

Station with PCX 57 processor

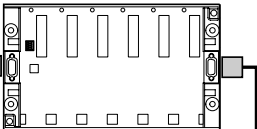

TSX CBY ..0K



⚠ The cumulative length of all the cables used in a PLC station must never exceed 100 meters.

⚠ The insertion or extraction of a TSX CBY ..0K cable must only be performed with all the racks of a station powered down.

• **Bus X extension cables : TSX CBY 1000 (length 100 meters)**

For Bus X lengths less than 100 meters between 2 racks, but not corresponding to those available already fitted with connectors, the TSX CBY 1000 cable must be used. The user must fit TSX CBY K9 connectors at each end of this cable. This procedure is described in the quick reference guide supplied with the cable and connectors.

Setting up this cable requires the following items :

- A length of TSX CBY 1000 cable with 2 testers to check the cable after the various accessories have been fitted.
- 2 x 9-pin TSX CBY K9 connectors with various accessories.
- A TSX CBY ACC10 kit comprising 2 crimping pliers and a tool to remove contacts in case of error.

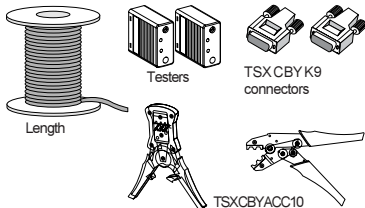

TSX TLYEX line terminator

When using extendable racks, a line terminator must be fitted at each end of the X Bus. The line terminator comprises a 9-pin SUB D connector and a cover which contains the adaptation components. The line terminators are mounted on the 9-pin SUB D connector which has not been used on the rack at the end of the line.

TSX TLY EX line terminators are sold in lots of 2 and labelled A/ and /B. The bus must have a line terminator A/ at one end and a line terminator /B at the other end, in no particular order.

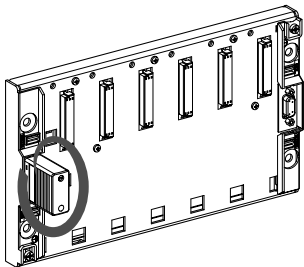

⚠ All the station racks must be powered down before fitting a line terminator.

• Positioning line terminators on a PLC station with a TSX/PMX 57 processor

- on a PLC station with several TSX RKY...EX extendable racks

www.DataSheet4U.com

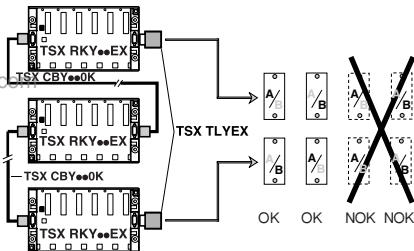

- on a PLC station with just one extendable rack. In this case, a line terminator must be fitted to each of the 9-pin SUB D 9 connectors on the rack

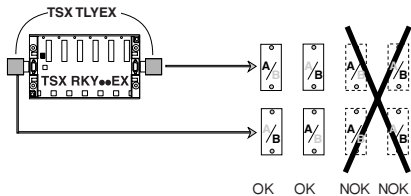

• Positioning line terminators on a PLC station with a PCX 57 processor

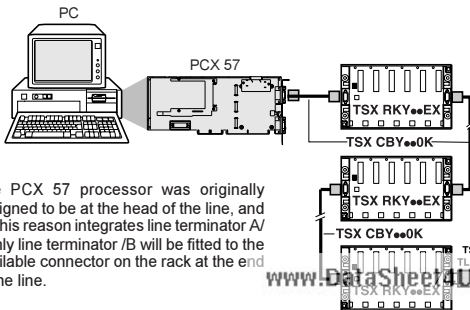

The PCX 57 processor was originally designed to be at the head of the line, and for this reason integrates line terminator A/. Only line terminator /B will be fitted to the available connector on the rack at the end of the line.

www.DataSheet4U.com

OK NOK

Special case:

In the case where nothing has been connected to the Bus X connector on the processor, line terminator /B must be mounted on this connector.

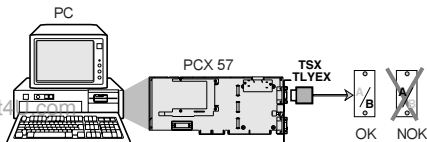

Protective cover for unoccupied position

If a position in a rack is unoccupied, it is recommended to place a TSX RKA 02 cover over the position.

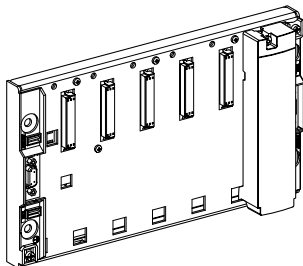

Labelling

• Labelling the positions of the modules in the rack

Each rack is supplied with a sheet of adhesive labels in order to mark the position of each of the modules.

PS	00	01	02	03	04	05	06
07	08	09	10	11	12	13	14

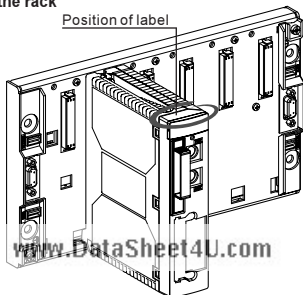

• Rack labelling

Each rack is supplied with a pack of clip-on markers on a strip which can be used to mark the address of the rack in the station and the network address of the station.

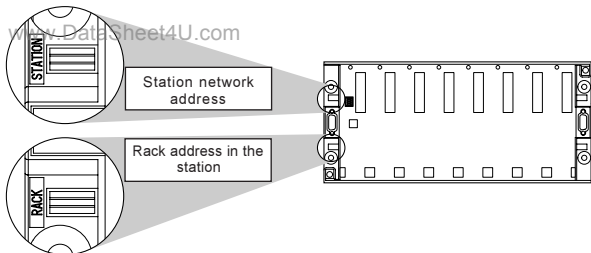

Presentation

TSX PSY power supply modules supply all the necessary voltages for modules installed on each TSX RKY ... rack. Each rack has its own power supply module.

In order to meet the various requirements, several module types are available :

- Standard and double format modules for 110-220V AC supply,
- Standard and double format modules for 24V DC supply, non-isolated.
- Double format module for 24...48V DC supply, isolated.

In addition, each module has auxiliary functions such as :

- A display block,
- An alarm relay,
- A slot which takes a battery for backing up the data in the processor internal RAM memory,
- A pencil-point type pushbutton which when pressed, simulates a power break, causing a warm restart of the application,
- 24VDC sensor power supply (only on modules powered by an AC supply).

Standard format modules

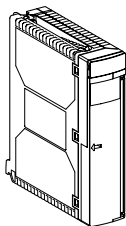

Double format modules

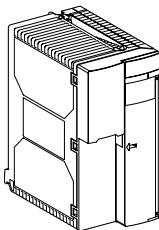

Catalog

Module format	Supply network voltage	Total useful power	Sensor power supply	References
standard	100...240VAC	26W	24VDC/0.6A	TSX PSY 2600
double	100...120VAC / 200...240VAC	50W 77/85/100W (1)	24VDC/0.9A 24VDC/1.6A	TSX PSY 5500 TSX PSY 8500
standard	24 VDC	26W	-	TSX PSY 1610
double	24 VDC	50W	-	TSX PSY 3610
double	24...48 VDC	50W	-	TSX PSY 5620

(1) 77 W at 60°C, 85 W at 55°C, 100 W at 55°C with fan-cooled rack

Physical description

- 1 Display block comprising :
 - an OK indicator lamp (green), on if operation is normal,
 - a BAT indicator lamp (red), on if the battery is defective or missing
 - a 24V indicator lamp (green), on when the sensor voltage is present and correct. Indicator lamp is only on TSX PSY 2600/5500/8500 modules.
- 2 Pencil-point RESET button. Causes a warm restart of the application when pressed.
- 3 Slot which takes a battery for backing up the processor internal RAM memory.
- 4 Cover which protects the module front panel.
- 5 Screw terminal block for connection :
 - to the power supply,
 - of the alarm relay contact,
 - of the sensor power supply for TSX PSY 2600/5500/8500 AC supply modules.
- 6 Hole for a cable clamp.
- 7 Fuse located under the module which protects :
 - the 24 VR voltage on the TSX PSY 3610 non-isolated power supply module.
 - the primary voltage on the TSX PSY 1610 non-isolated DC power supply module.

Note : on TSX PSY 2600/5500/5520/8500 power supplies, the fuse protecting the primary voltage is internal to the module and cannot be accessed.
- 8 110/220 voltage selector, present only on the TSX PSY 5500/8500 power supply modules. At the time of supply, the selector is set to 220.

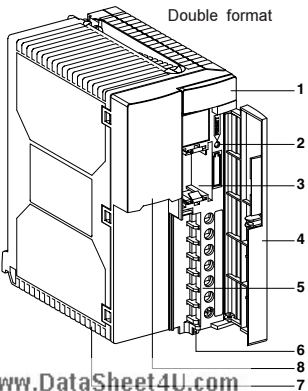
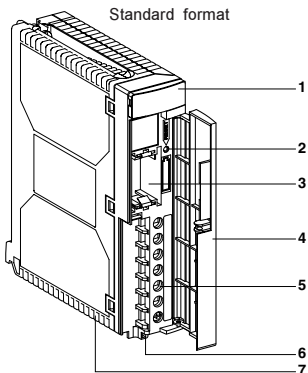

Auxiliary functions

- **Alarm relay**: included in every power supply module, this relay has a volt-free contact which can be accessed on the module connection block.

- **Alarm relay of module located on the rack with the processor (rack 0)**:
In normal operation (PLC in RUN), the relay is activated and its contact closed (state 1). On every stop, even partial, appearance of a blocking fault, incorrect output voltages or disappearance of the supply voltage, the relay drops out and the contact opens (state 0).

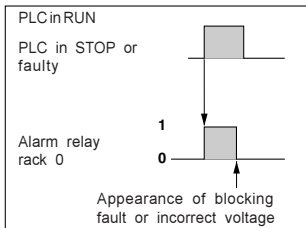

Note : when using a PCX 57 type processor, the alarm relay is not managed and is therefore constantly open. If this function is indispensable for the correct operation of the installation, this alarm relay can be replaced by using a relay output from another module on the Bus X or FIPIO bus. To achieve this, the output must be a relay output which has been configured with fallback to 0 and initialized at state 1 at the start of the execution of the application program.

- **Alarm relay for modules located on other racks (racks 1 to 7)** :

In this case, when the power supply module is powered up and if the output voltages are correct, the alarm relay is activated and its contact closed (state 1). On disappearance of the supply voltage or if the output voltages are incorrect, the relay drops out (state 0).

These operating modes enable the contacts to be used in external positive safety circuits, such as the interlocking of preactuator power supplies.

- **Backup battery** : this ensures protection of the internal RAM memory of the TSX/PMX 57 processor. Supplied in the same packaging as the module, it must be fitted by the user, taking care to respect the polarities.
 - Battery characteristics : thionil chloride lithium battery, 3.6V / 0.8 Ah, size1 / 2AA.
 - Replacement part reference : TSX PLP 01.
 - Battery check : If there are any problems, the BAT lamp will come on. If this occurs, change the battery immediately.
 - Battery backup period :

Ambient temperature when not operating		≤ 30°C	40°C	50°C	60°C
Backup period	PLC switched off 12 hours/day	5 yrs	3 yrs	2yrs	1yr
	PLC switched off 1 hour/day	5 yrs	5 yrs	4.5yrs	4 yrs

- Protection while changing battery : the battery should be changed while the module is powered up or immediately after powering down. In the latter case, the intervention time is limited. After a certain period of time the data in the RAM memory will be lost.

Ambient temperature during power down		20°C	30°C	40°C	50°C
Backup period		2 h	45 min	20 min	8 min

Note : with a PCX 57 processor, it is of no benefit to provide a battery in the power supply of the rack which receives the processor virtually (rack at address 0). In this case, the battery which is used to protect the processor internal RAM memory, is mounted on it.

- **Display** : 3 indicator lamps (OK, BAT, 24V) on TSX PSY 2600/5500/8500 modules and 2 indicator lamps (OK, BAT) on TSX PSY 1610/3610/5520 modules.
- OK indicator lamp (green) : on during normal operation, off if the output voltages are no longer present or correct,
- BAT indicator lamp (red) : on if battery missing, run down, incompatible or wrong way round and off during normal operation,
- 24V indicator lamp (green) : on during normal operation, off if the 24V sensor voltage is no longer present.
- **RESET pushbutton** : action on this pushbutton (press and release) effects a warm restart of the application.
- **Sensor power supply** : available on TSX PSY 2600/5500/8500 AC power supplies, it provides the 24 VDC sensor supply.



Installation / Mounting

Installation

- TSX PSY 2600/1610 standard format power supply modules :
These are installed in the first slot of each TSX RKY ... rack and occupy position PS.
- TSX PSY 3610/5500/5520/8500 double format power supply modules :

These are installed in the first two slots of each TSX RKY ... rack and occupy positions PS and 00.

Note : the power supply modules have a locating system which ensures that they can only be installed in the slots designated above.

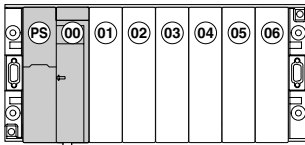
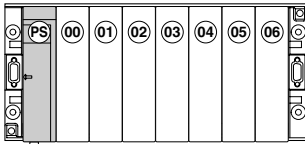

- **Insertion** : (see section on mounting modules in this document)
- ⚠ **When inserting or removing a TSX PSY power supply module, the external power supplies must be powered down.**

Characteristics

• Non-isolated power supplies for DC line supply

Module references		TSX PSY 1610	TSX PSY 3610	
Primary	Nominal voltages	24 VDC	24 VDC	
	Limit voltages (1) (ripple included)	19.2...30 VDC (possible up to 34V for 1H / 24 H)	19.2...30 VDC	
	Nominal current drawn	≤ 1.5 A at 24V	≤ 2.7 A at 24V	
	Initial power I _i inrush	≤ 100 A at 24 V	≤ 150 A	
	up at 25°C (2) I _t on energization	0.2 As at 24 V	0.5 As at 24 V	
	I _t ² on energization	12.5 A ² s at 24 V	20 A ² s at 24 V	
	Accepted duration of micro-cuts	≤ 1 ms	≤ 1 ms	
	Integrated protection on + input (fuse located under the module)	via 5x20 fuse, UL, delayed action, 3.5 A	no	
	Secondary	Total useful power	30 W	50 W
		5 VDC output	Nominal voltage	5 VDC
Power			15 W	35 W
24VR output (3) (24V relay)		Nominal voltage	U _{primary} – 0.6V	U _{primary} – 0.6V
		Power	15 W	19 W
Outputs protected against (4)		overloads/short-circuits/overvoltages		
Dissipated power	10 W	15 W		
Conformity to standards	IEC 1131-2			

(1) For the power supply to "relay output" modules, the range is reduced to 21.6...26.4V.

(2) These values should be taken into account when calculating the size of line protection devices upstream of the power supply.

(3) 24 V --- output for supplying "relay output" module relays.

(4) The 24 VR output is protected by a fuse located under the module (4 A, 5x20, type M).

Characteristics (cont'd)

• Isolated power supplies for DC line supply

Module references		TSX PSY 5520	
Primary	Nominal voltages	24...48 VDC	
	Limit voltages (including ripple)	19.2...60 VDC	
	Nominal current drawn	≤ 3 A at 24 V ≤ 1.5 A at 48 V	
	Initial power up at 25°C (1)	I inrush	≤ 15 A at 24 V ≤ 15 A at 48 V
		I _t on energization	7 As at 24 V 6 As at 48 V
		I ² t on energization	50 A ² s at 24 V 55 A ² s at 48 V
	Accepted duration of micro-cuts	- 1 ms	
	Integrated protection on + input	via internal fuse, not accessible	
	Secondary	Total useful power	50 W
		5 VDC output	Nominal voltage
Power			35 W
24VR output (2) (24V relay)		Nominal voltage	24 VDC
		Power	19 W
Outputs protected against	overloads/short-circuits/overvoltages		
Dissipated power	20 W		
Conformity to standards	IEC 1131-2		
Isolation	Dielectric strength	primary/secondary primary/ground	2000V rms - 50/60 Hz - 1min 2000V rms - 50/60 Hz - 1min

(1) These values should be taken into account when calculating the size of line protection devices upstream of the power supply.

(2) 24 V --- output for supplying "relay output" module relays.

• Alarm relay contact

Limit operating voltage	~ 19...264 VAC or ---10...30 VDC (1)			
AC load	Usual voltages	24 VAC	48VAC	110 VAC 220 VAC
	Power on resistive load	50 VA	50 VA	110 VA 220 VA
	Power on inductive load	24 VA	24 VA	50 VA 110 VA
DC load	Usual voltages	245 VDC		
	Power on resistive or inductive load	24W		
Isolation	contact/ground	www.DataSheet4U.com		
Protection to be integrated at load terminals	RC or MOV in ~, flywheel diode in ---			

(1) possible up to 34 VDC for 1 hour in 24.

Characteristics (cont'd)

• Power supplies for AC line supply

Module references		TSX PSY 2600	TSX PSY 5500	
Primary	Nominal voltages	100...240 VAC	100...120/200...240VAC	
	Limit voltages	85...264 VAC	85...140/190...264 VAC	
	Nominal/limit frequencies	50-60/47-63 Hz	50-60/47-63 Hz	
	Apparent power	50 VA	150 VA	
	Nominal current drawn	≤ 0.5 A at 100V ≤ 0.3 A at 240V	≤ 1.7 A at 100V ≤ 0.5 A at 240V	
	Initial I inrush powerup at 25°C (1)		≤ 37 A at 100 V ≤ 75 A at 240 V	≤ 38 A at 100 V ≤ 38 A at 240 V
		It on energization	0.034 As at 100 V 0.067 As at 240 V	0.11 As at 100 V 0.11 As at 240 V
		I _{it} on energization	0.63 A ² s at 100 V 2.6 A ² s at 240 V	4 A ² s at 100 V 2 A ² s at 240 V
	Accepted duration of micro-cuts	≤ 10 ms	≤ 10 ms	
	Integrated protection on phase	via internal fuse, not accessible		
Secondary	Total useful power	26 W	50 W	
	5 VDC output	Nominal voltage	5.1 VDC	5.1 VDC
		Power	25 W	35 W
	24VR output (2)	Nominal voltage	24 VDC	24 VDC
		Power	15 W	19 W
	24VC output (3)	Nominal voltage	24 VDC	24 VDC
		Power	12 W	19 W
Outputs protected against	overloads/short-circuits/overvoltages			
Dissipated power		10 W	20 W	
Conformity to standards		IEC 1131-2	IEC 1131-2	
Isolation	Dielectric strength	primary/secondary	2000 Vrms - 50/60 Hz - 1min	
		primary/ground	2000 Vrms - 50/60 Hz - 1min	

(1) These values should be taken into account when calculating the size of line protection devices upstream of the power supply.

(2) 24 V ∓ output for supplying "relay output" module relays.

(3) 24 V ∓ output for the sensor power supply. It cannot be paralleled with an external power supply.

Characteristics (cont'd)

• Power supplies for AC line supply (cont'd)

Module references		TSX PSY 8500	
Primary	Nominal voltages	100...120/200...240 VAC	
	Limit voltages	85...140/170...264 VAC	
	Nominal/limit frequencies	50-60/47-63 Hz	
	Apparent power	150 VA	
	Nominal current drawn	≤ 1.4 A at 100V ≤ 0.5 A at 240V	
	Initial I inrush power up		≤ 30 A at 100 V ≤ 60 A at 240 V
		at 25°C	
	(1)	I _t on energization	0.15 As at 100 V 0.15 As at 240 V
		I ² t on energization	15 A ² s at 100 V 8 A ² s at 240 V
	Accepted duration of micro-cuts		≤ 10 ms
Integrated protection on phase		via internal fuse, not accessible	
Secondary	Total useful power	77/85/100 W (2)	
	5 VDC output	Nominal voltage	5.1 VDC
		Power	75 W
	24VR output (3)	Nominal voltage	not supplied
		Power	not supplied
	24VC output (4)	Nominal voltage	24 VDC
		Power	38 W
Outputs protected against		overloads/short-circuits/overvoltages	
Dissipated power		20 W	
Conformity to standards		IEC 1131-2	
Isolation	Dielectric strength	primary/secondary	3000V rms - 50/60 Hz - 1min
		primary/ground	3000V rms - 50/60 Hz - 1min

- (1) These values should be taken into account when calculating the size of line protection devices upstream of the power supply.
- (2) 77W at 60°C, 85W at 60°C, 100W at 55°C with rack cooled by TSX FAN • ventilation modules.
- (3) 24 V_{DC} output not supplied on this power supply. The mounting of relay output modules is therefore not permitted on racks with this power supply module.
- (4) 24 V_{DC} output for the sensor power supply. It cannot be paralleled with an external power supply.

• Service conditions for TSX Premium PLCs

Operation

Ambient operating temperature	0°C to + 60°C
Relative humidity	10% to 95% (without condensation)
Altitude	0 to 2000 meters

Storage

Storage temperature	25°C to + 70°C
Relative humidity	5% to 95% (without condensation)

Connection rules

- **Connections** : The power supply module screw terminal block is equipped with captive screw clamp terminals enabling the connection of 1 wire with maximum cross section of 2.5mm² or 2 wires with a cross section of 1.5mm² with ends. The wires exit vertically downwards, and can be secured with a cable clamp. For DC power supplies, limit the length of the connection cable to the supply to prevent any line losses (see below).

Module references	Cable lengths
TSX PSY 1610	30 meters (60 meters in total) with copper wires of 2.5 mm ² 20 meters (40 meters in total) with copper wires of 1.5 mm ²
TSX PSY 3610 / 5520	15 meters (30 meters in total) with copper wires of 2.5 mm ² 10 meters (20 meters in total) with copper wires of 1.5 mm ²

- **Tightening torque for terminal block screw clamp**: 0.8 N.m maximum

- **Protection** : Locate a protective device and a power breaker upstream of the PLC station.

Note : Given that the DC power supplies have a very strong inrush current, it is not advisable to use them on DC supplies with return current protection (fold back)

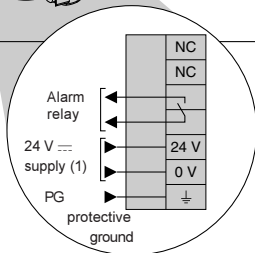
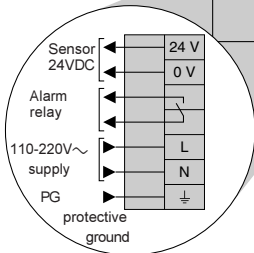
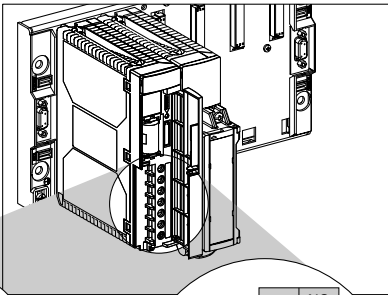

Power supply for an AC supply :
TSX PSY 2600/5500/8500

- ⚠ TSX PSY 5500/8500 : set the voltage selector position according to the mains voltage being used 110 or 220 VAC

Power supply for a DC supply :

TSX PSY 1610/3610/5520

www.DataSheet4U.com

(*) 24...48 VDC for the TSX PSY 5520 power supply

Grounding the racks

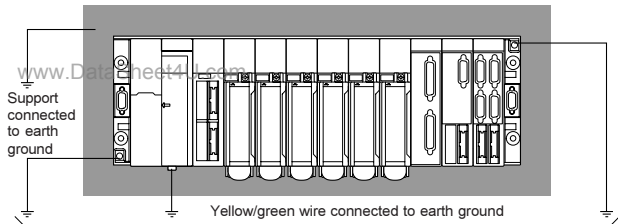

Important

The internal 0V is connected to the mechanical ground. The mechanical ground is in turn connected to earth ground.

Connecting the power supplies

• TSX PSY 2600 / 5500 / 8500 modules

AC supply 100...240V

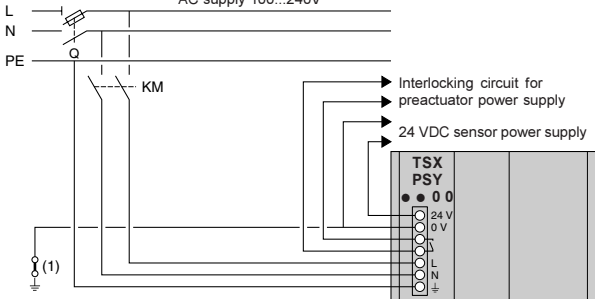

Q: General isolator.

KM: Line contactor or circuit-breaker.

These power supplies have an integrated protection device (PS-400), which is situated inside the module and cannot be accessed.

(1) Isolation strip for locating any ground connection fault.

• TSX PSY 1610 / 3610 non isolated power supply module

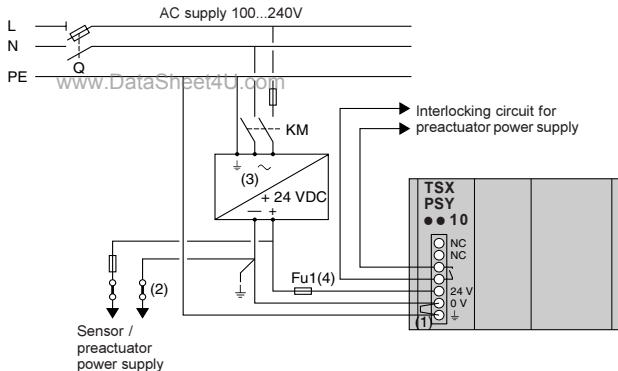

Q : General isolator

KM : Line contactor or circuit-breaker

- (1) External shunt provided with power supply module.
- (2) Isolation strip for locating ground connection fault. In this case, the power supply must be disconnected in order to disconnect the supply from ground.
- (3) TSX SUP 1ii1 process power supply can be used.
- (4) External protection fuse (4 A, delayed action type) only on TSX PSY 3610 module. The TSX PSY 1610 module has an integrated protection fuse (3.5A, 5x20, UL, delayed action type), situated inside the module and in series with the 24V input.

• TSX PSY 5520 isolated power supply module

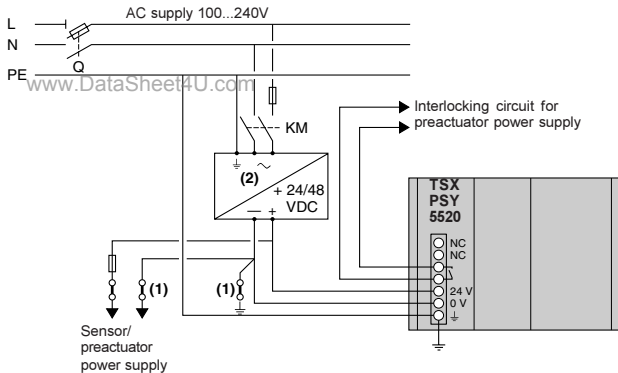

Q : General isolator

KM : Line contactor or circuit-breaker

- (1) Isolation strip for locating ground connection fault
- (2) TSX SUP 1ii1 process power supply can be used

The TSX PSY 5520 module has an integrated protection fuse in series with the 24V input, which is situated inside the module and cannot be accessed.

Alarm relay connections

Interlocking circuit for sensor and preactuator power supply

- Example 1 : PLC station powered by the AC line

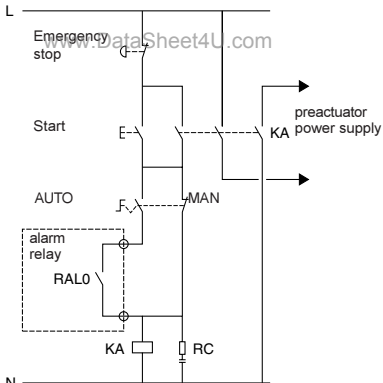

(1) all power supply alarm relay contacts to be connected in series (RAL0, RAL 1, RAL2, etc)

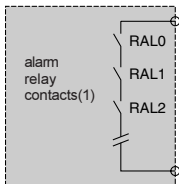

- Example 2 : PLC station powered by the DC line

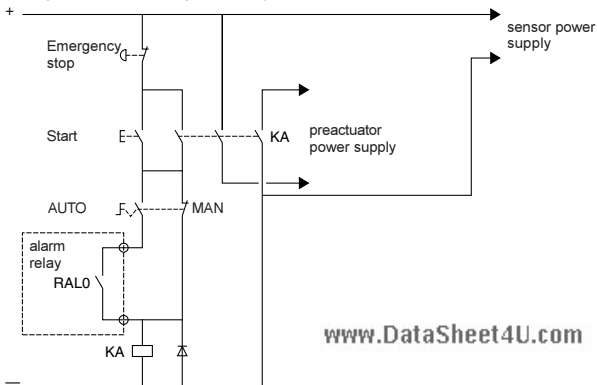

www.DataSheet4U.com

www.DataSheet4U.com

www.DataSheet4U.com

www.DataSheet4U.com

www.DataSheet4U.com

www.DataSheet4U.com

03



Schneider Automation Inc.
One High Street
North Andover, MA 01845
Tél.: (1) 978 794 0800
Fax : (1) 978 975 9010

Schneider Automation SAS
245, route des Lucioles - BP 147
F-06903 Sophia Antipolis
Tél. : (33) (0)4 92 38 20 00
Fax : (33) (0)4 93 65 30 31

Schneider Automation GmbH
Steinheimer Straße 117
D-63500 Seligenstadt
Tél. : (49) 61 82 81 29 00
Fax : (49) 61 82 81 21 55

www.DataSheet4U.com