

TV04A5V0-G Thru. TV04A441-G

Working Peak Reverse Voltage: 5.0 to 440 Volts

Power Dissipation: 400 Watts

RoHS Device

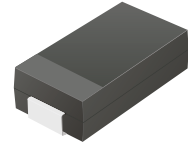

Features

- Ideal for surface mount applications.
- Easy pick and place.
- Plastic package has Underwriters Lab. flammability classification 94V-0.
- Typical IR less than 1 μ A above 10V.
- Fast response time: typically less than 1nS for uni-direction, less than 5nS for bi-direction, from 0V to BV min.

Mechanical data

- Case: SMA/DO-214AC, molded plastic.
- Terminals: solderable per MIL-STD-750, method 2026.
- Polarity: Color band denotes cathode end.
- Approx. weight: 0.064 grams

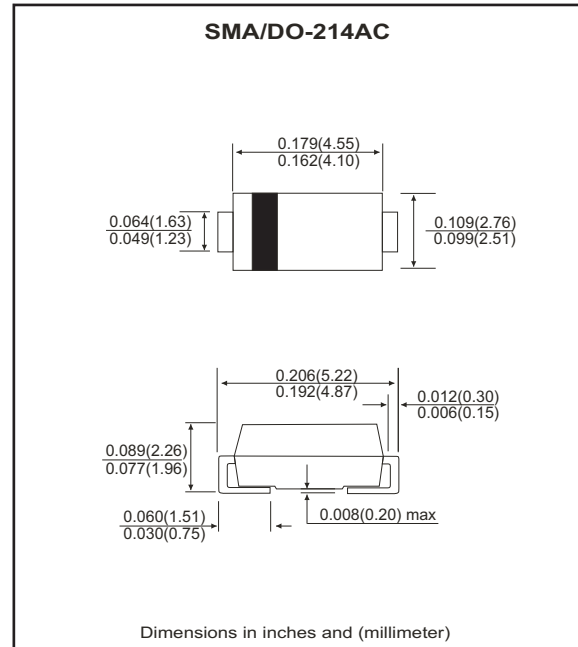

Maximum Ratings and Electrical Characteristics

Ratings at 25 °C ambient temperature unless otherwise specified.
 Single phase, half wave, 60Hz, resistive or inductive load.
 For capacitive load, derate current by 20%.

Characteristics	Symbol	Value	Units
Peak power dissipation on 10/1000 μ S waveform (Note1)	P _{PPM}	400	W
Peak pulse current on 10/1000 μ S waveform (Note 1)	I _{PPM}	See Next Table	A
Steady state power dissipation at T _L =75°C	P _{M(AV)}	1.0	W
Peak forward surge current, 8.3mS single half sine-wave unidirectional only (Note 2)	I _{FSM}	40	A
Maximum instantaneous forward voltage at 25.0A for unidirectional only (Note 3)	V _F	3.5/5.0	V
Maximum operating junction temperature	T _J	-55 to +150	°C
Storage temperature range	T _{STG}	-55 to +150	°C

Notes:

1. Non-repetitive current pulse, per Fig. 5 and derated above T_A=25°C, per Fig. 1.
2. Measured on 8.3mS single half sine-wave or equare wave, duty cycle=4 pulses per minute maximum.
3. V_F<3.5V for devices of V_{BR}<200V and V_F<5.0V for devices of V_{BR}>201V

RATING AND CHARACTERISTIC CURVES (TV04A5V0-G Thru. TV04A441-G)

Fig.1- Pulse Derating Curve

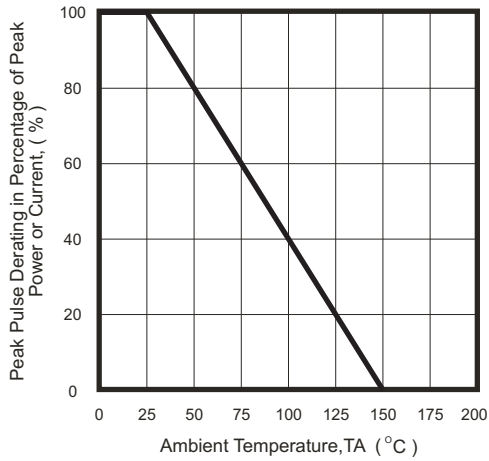

Fig.2- Maximum Non-Repetitive Surge Current

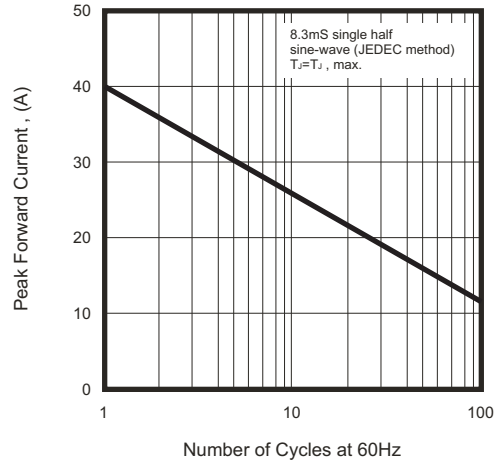

Fig.3- Steady State Power Derating Curve

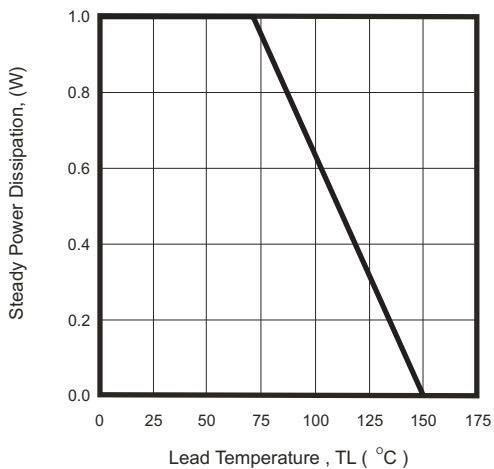

Fig.4- Peak Pulse Power Rating Curve

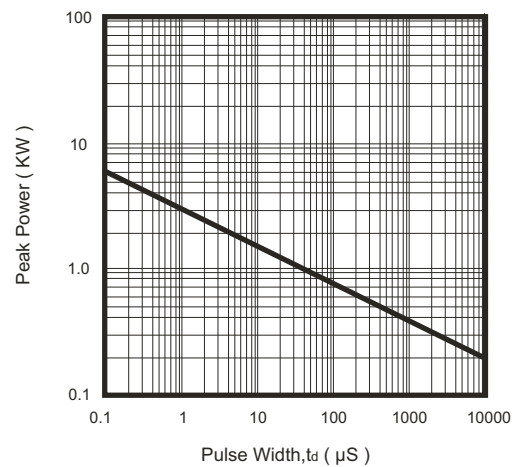

Fig.5- Pulse Waveform

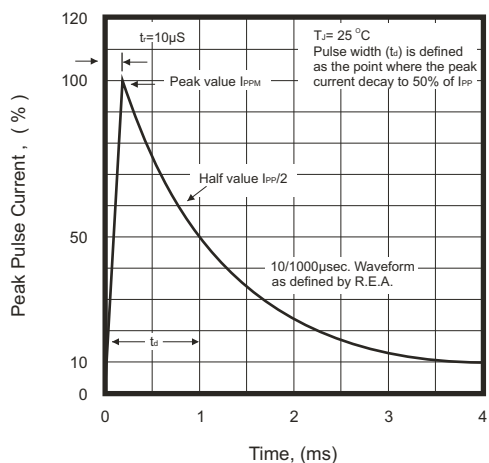
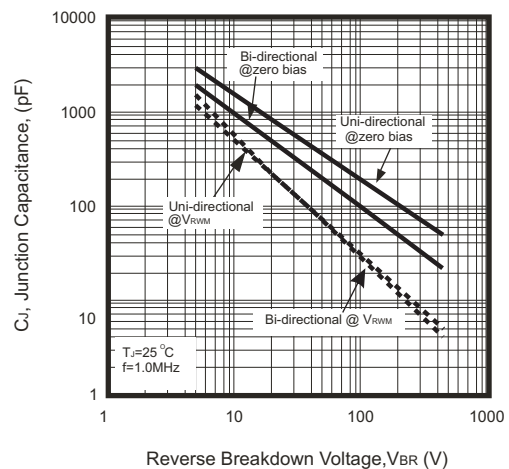

Fig.6- Typical Junction Capacitance



SMD Transient Voltage Suppressor



Electrical Characteristics (T_A=25°C TV04A5V0-G Thru. TV04A441-G)

Part No	Absolute Maximum Rating (Ta=25°C)					Electrical Characteristic (Ta=25°C)				
	V _{RWM}	V _{BR} Min.	V _{BR} Max.	I _T	I _{FSM}	Max. V _C	I _R @ V _{RWM}	Marking Code		
	(V)	(V)	(V)	(mA)	(A)@8.3mS	(V)	I _{PP} (A)	(uA)	Uni	Bi
TV04A5V0K(B)-G	5.00	6.40	7.30	10	40	9.60	41.67	800	AD	WD
TV04A5V0J(B)-G	5.00	6.46	7.00	10	40	9.20	43.48	800	AE	WE
TV04A6V0K(B)-G	6.00	6.67	8.15	10	40	11.4	35.09	800	AF	WF
TV04A6V0J(B)-G	6.00	6.67	7.37	10	40	10.3	38.83	800	AG	WG
TV04A6V5K(B)-G	6.50	7.22	8.82	10	40	12.3	32.52	500	AH	WH
TV04A6V5J(B)-G	6.50	7.22	7.98	10	40	11.2	35.71	500	AK	WK
TV04A7V0K(B)-G	7.00	7.78	9.51	10	40	13.3	30.08	200	AL	WL
TV04A7V0J(B)-G	7.00	7.78	8.60	10	40	12.0	33.33	200	AM	WM
TV04A7V5K(B)-G	7.50	8.33	10.20	1	40	14.3	27.97	100	AN	WN
TV04A7V5J(B)-G	7.50	8.33	9.21	1	40	12.9	31.01	100	AP	WP
TV04A8V0K(B)-G	8.00	8.89	10.90	1	40	15.0	26.67	50	AQ	WQ
TV04A8V0J(B)-G	8.00	8.89	9.83	1	40	13.6	29.41	50	AR	WR
TV04A8V5K(B)-G	8.50	9.44	11.50	1	40	15.9	25.16	10	AS	WS
TV04A8V5J(B)-G	8.50	9.44	10.40	1	40	14.4	27.78	10	AT	WT
TV04A9V0K(B)-G	9.00	10.00	12.20	1	40	16.9	23.67	5	AU	WU
TV04A9V0J(B)-G	9.00	10.00	11.10	1	40	15.4	25.97	5	AV	WV
TV04A100K(B)-G	10.0	11.10	13.60	1	40	18.8	21.28	5	AW	WW
TV04A100J(B)-G	10.0	11.10	12.30	1	40	17.0	23.53	5	AX	WX
TV04A110K(B)-G	11.0	12.20	14.90	1	40	20.1	19.90	5	AY	WY
TV04A110J(B)-G	11.0	12.20	13.50	1	40	18.2	21.98	5	AZ	WZ
TV04A120K(B)-G	12.0	13.30	16.30	1	40	22.0	18.18	5	BD	XD
TV04A120J(B)-G	12.0	13.30	14.70	1	40	19.9	20.10	5	BE	XE
TV04A130K(B)-G	13.0	14.40	17.60	1	40	23.8	16.81	5	BF	XF
TV04A130J(B)-G	13.0	14.40	15.90	1	40	21.5	18.60	5	BG	XG
TV04A140K(B)-G	14.0	15.60	19.10	1	40	25.8	15.50	5	BH	XH
TV04A140J(B)-G	14.0	15.60	17.20	1	40	23.2	17.24	5	BK	XK
TV04A150K(B)-G	15.0	16.70	20.40	1	40	26.9	14.87	5	BL	XL
TV04A150J(B)-G	15.0	16.70	18.50	1	40	24.4	16.39	5	BM	XM
TV04A160K(B)-G	16.0	17.80	21.80	1	40	28.8	13.89	5	BN	XN
TV04A160J(B)-G	16.0	17.80	19.70	1	40	26.0	15.38	5	BP	XP
TV04A170K(B)-G	17.0	18.90	23.10	1	40	30.5	13.11	5	BQ	XQ
TV04A170J(B)-G	17.0	18.90	20.90	1	40	27.6	14.49	5	BR	XR
TV04A180K(B)-G	18.0	20.00	24.40	1	40	32.2	12.42	5	BS	XS
TV04A180J(B)-G	18.0	20.00	22.10	1	40	29.2	13.70	5	BT	XT
TV04A190K(B)-G	19.0	21.13	25.76	1	40	34.0	11.76	5	BA	XA
TV04A190J(B)-G	19.0	20.10	23.30	1	40	30.8	13.00	5	BB	XB
TV04A200K(B)-G	20.0	22.20	27.10	1	40	35.8	11.17	5	BU	XU
TV04A200J(B)-G	20.0	22.20	24.50	1	40	32.4	12.35	5	BV	XV
TV04A220K(B)-G	22.0	24.40	29.80	1	40	39.4	10.15	5	BW	XW
TV04A220J(B)-G	22.0	24.40	26.90	1	40	35.5	11.27	5	BX	XX
TV04A240K(B)-G	24.0	26.70	32.60	1	40	43.0	9.30	5	BY	XY
TV04A240J(B)-G	24.0	26.70	29.50	1	40	38.9	10.28	5	BZ	XZ
TV04A260K(B)-G	26.0	28.90	35.30	1	40	46.6	8.58	5	CD	YD
TV04A260J(B)-G	26.0	28.90	31.90	1	40	42.1	9.50	5	CE	YE
TV04A280K(B)-G	28.0	31.10	38.00	1	40	50.0	8.00	5	CF	YF
TV04A280J(B)-G	28.0	31.10	34.40	1	40	45.4	8.81	5	CG	YG
TV04A300K(B)-G	30.0	33.30	40.70	1	40	53.5	7.48	5	CH	YH
TV04A300J(B)-G	30.0	33.30	36.80	1	40	48.4	8.26	5	CK	YK
TV04A330K(B)-G	33.0	36.70	44.90	1	40	59.0	6.78	5	CL	YL
TV04A330J(B)-G	33.0	36.70	40.60	1	40	53.3	7.50	5	CM	YM
TV04A360K(B)-G	36.0	40.00	48.90	1	40	64.3	6.22	5	CN	YN
TV04A360J(B)-G	36.0	40.00	44.20	1	40	58.1	6.88	5	CP	YP

SMD Transient Voltage Suppressor



Electrical Characteristics (TV04A5V0-G Thru. TV04A441-G)

Part No	Absolute Maximum Rating (Ta=25°C)					Electrical Characteristic (Ta=25°C)				
	V _{RWM}	V _{BR} Min.	V _{BR} Max.	I _T	I _{FSM}	Max. V _C	I _R @ V _{RWM}	Marking Code		
	(V)	(V)	(V)	(mA)	(A)@8.3mS	(V)	I _{PP} (A)	(uA)	Uni	Bi
TV04A400K(B)-G	40.0	44.40	54.30	1	40	71.4	5.60	5	CQ	YQ
TV04A400J(B)-G	40.0	44.40	49.10	1	40	64.5	6.20	5	CR	YR
TV04A430K(B)-G	43.0	47.80	58.40	1	40	76.7	5.22	5	CS	YS
TV04A430J(B)-G	43.0	47.80	52.80	1	40	69.4	5.76	5	CT	YT
TV04A450K(B)-G	45.0	50.00	61.10	1	40	80.3	4.98	5	CU	YU
TV04A450J(B)-G	45.0	50.00	55.30	1	40	72.7	5.50	5	CV	YV
TV04A480K(B)-G	48.0	53.30	65.10	1	40	85.5	4.68	5	CW	YW
TV04A480J(B)-G	48.0	53.30	58.90	1	40	77.4	5.17	5	CX	YX
TV04A510K(B)-G	51.0	56.70	69.30	1	40	91.1	4.39	5	CY	YY
TV04A510J(B)-G	51.0	56.70	62.70	1	40	82.4	4.85	5	CZ	YZ
TV04A540K(B)-G	54.0	60.00	73.30	1	40	96.3	4.15	5	RD	ZD
TV04A540J(B)-G	54.0	60.00	66.30	1	40	87.1	4.59	5	RE	ZE
TV04A580K(B)-G	58.0	64.40	78.70	1	40	103.0	3.88	5	RF	ZF
TV04A580J(B)-G	58.0	64.40	71.20	1	40	93.6	4.27	5	RG	ZG
TV04A600K(B)-G	60.0	66.70	81.50	1	40	107.0	3.74	5	RH	ZH
TV04A600J(B)-G	60.0	66.70	73.70	1	40	96.8	4.13	5	RK	ZK
TV04A640K(B)-G	64.0	71.10	86.90	1	40	114.0	3.51	5	RL	ZL
TV04A640J(B)-G	64.0	71.10	78.60	1	40	103.0	3.88	5	RM	ZM
TV04A700K(B)-G	70.0	77.80	95.10	1	40	125.0	3.20	5	RN	ZN
TV04A700J(B)-G	70.0	77.80	86.00	1	40	113.0	3.54	5	RP	ZP
TV04A750K(B)-G	75.0	83.30	102.00	1	40	134.0	2.99	5	RQ	ZQ
TV04A750J(B)-G	75.0	83.30	92.10	1	40	121.0	3.31	5	RR	ZR
TV04A780K(B)-G	78.0	86.70	106.00	1	40	139.0	2.88	5	RS	ZS
TV04A780J(B)-G	78.0	86.70	95.80	1	40	126.0	3.17	5	RT	ZT
TV04A800K(B)-G	80.0	88.96	108.80	1	40	143.2	2.79	5	RA	ZA
TV04A800J(B)-G	80.0	88.80	97.60	1	40	129.6	3.09	5	RB	ZB
TV04A850K(B)-G	85.0	94.40	115.00	1	40	151.0	2.65	5	RU	ZU
TV04A850J(B)-G	85.0	94.40	104.00	1	40	137.0	2.92	5	RV	ZV
TV04A900K(B)-G	90.0	100.00	122.00	1	40	160.0	2.50	5	RW	ZW
TV04A900J(B)-G	90.0	100.00	111.00	1	40	146.0	2.74	5	RX	ZX
TV04A101K(B)-G	100.0	111.00	136.00	1	40	179.0	2.23	5	RY	ZY
TV04A101J(B)-G	100.0	111.00	123.00	1	40	162.0	2.47	5	RZ	ZZ
TV04A111K(B)-G	110.0	122.00	149.00	1	40	196.0	2.04	5	SD	VD
TV04A111J(B)-G	110.0	122.00	135.00	1	40	177.0	2.26	5	SE	VE
TV04A121K(B)-G	120.0	133.00	163.00	1	40	214.0	1.87	5	SF	VF
TV04A121J(B)-G	120.0	133.00	147.00	1	40	193.0	2.07	5	SG	VG
TV04A131K(B)-G	130.0	144.00	176.00	1	40	231.0	1.73	5	SH	VH
TV04A131J(B)-G	130.0	144.00	159.00	1	40	209.0	1.91	5	SK	VK
TV04A141K(B)-G	140.0	155.68	190.40	1	40	250.6	1.60	5	SA	VA
TV04A141J(B)-G	140.0	155.00	171.00	1	40	226.8	1.76	5	SB	VB
TV04A151K(B)-G	150.0	167.00	204.00	1	40	268.0	1.49	5	SL	VL
TV04A151J(B)-G	150.0	167.00	185.00	1	40	243.0	1.65	5	SM	VM
TV04A161K(B)-G	160.0	178.00	218.00	1	40	287.0	1.39	5	SN	VN
TV04A161J(B)-G	160.0	178.00	197.00	1	40	259.0	1.54	5	SP	VP
TV04A171K(B)-G	170.0	189.00	231.00	1	40	304.0	1.32	5	SQ	VQ
TV04A171J(B)-G	170.0	189.00	209.00	1	40	275.0	1.45	5	SR	VR
TV04A181K(B)-G	180.0	200.16	244.80	1	40	322.2	1.24	5	SS	VS
TV04A181J(B)-G	180.0	200.00	220.00	1	40	291.6	1.37	5	ST	VT

SMD Transient Voltage Suppressor



Electrical Characteristics (TV04A5V0-G Thru. TV04A441-G)

Part No.	Absolute Maximum Rating (T _A =25 °C)					Electrical Characteristic (T _A =25 °C)				
	V _{RWM}	V _{BR} Min.	V _{BR} Max.	I _T	I _{FSM}	Max V _C		I _R @V _{RWM}	Marking Code	
	(V)	(V)	(V)	(mA)	(A)@8.3mS	(V)	I _{PP} (A)	(uA)	Uni	Bi
TV04A191K(B)-G	190.0	211.28	258.40	1	40	340.1	1.18	5	SU	VU
TV04A191J(B)-G	190.0	211.00	232.00	1	40	307.8	1.30	5	SV	VV
TV04A201J(B)-G	200.0	224.00	247.00	1	40	324.0	1.23	5	SW	VW
TV04A221J(B)-G	220.0	246.00	272.00	1	40	356.0	1.12	5	SX	VX
TV04A251J(B)-G	250.0	279.00	309.00	1	40	405.0	0.99	5	SZ	VZ
TV04A301J(B)-G	300.0	335.00	371.00	1	40	486.0	0.82	5	DE	HE
TV04A351J(B)-G	350.0	391.00	432.00	1	40	567.0	0.71	5	DG	HG
TV04A401J(B)-G	400.0	447.00	494.00	1	40	648.0	0.62	5	DK	HK
TV04A441J(B)-G	440.0	492.00	543.00	1	40	713.0	0.56	5	DM	HM

Note:

- 1) Suffix K denotes 10% tolerance devices, suffix J denotes 5% tolerance devices.
- 2) Suffix B after part number to specify Bi-directional devices.
- 3) For Bi-Directional devices having V_R of 10 volts and under, the I_R limit is double.

Reel Taping Specification

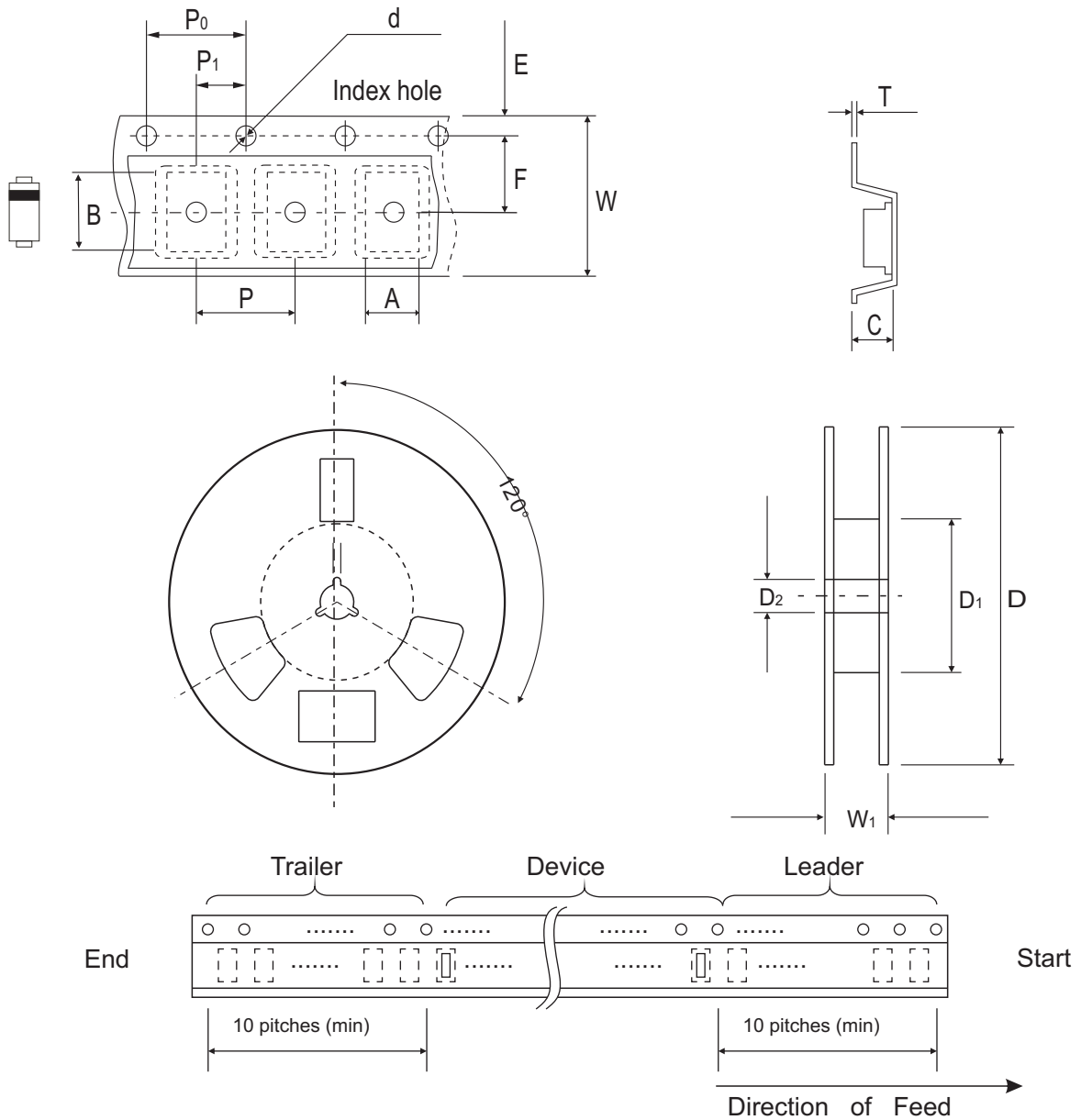

SMA/DO-214AC	SYMBOL	A	B	C	d	D	D1	D2
	(mm)	2.79 ± 0.10	5.33 ± 0.10	4.50 (max)	1.75 ± 0.10	330MAX	50.0 MIN.	13.0 ± 0.2
	(inch)	0.110 ± 0.004	0.210 ± 0.004	0.177 (max)	0.069 ± 0.004	13.00MAX	1.969 MIN.	0.512 ± 0.008

SMA/DO-214AC	SYMBOL	E	F	P	P0	P1	W	W1
	(mm)	1.75 ± 0.10	5.50 ± 0.05	4.00 ± 0.10	4.00 ± 0.10	2.00 ± 0.05	12.0 ± 0.30	18.4 MAX.
	(inch)	0.068 ± 0.004	0.216 ± 0.002	0.157 ± 0.004	0.157 ± 0.004	0.079 ± 0.002	0.472 ± 0.012	0.724 MAX.

Marking Code

1. C: COMCHIP
2. ○: Package

○	PKG
A	SMA
B	SMB
C	SMC

3. XX: Marking code(see Page. 3~5)
4. Cathod Band

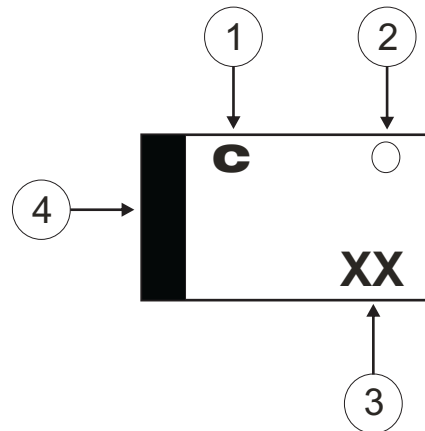

Suggested PAD Layout

SIZE	SMA/DO-214AC	
	(mm)	(inch)
A	3.80	0.150
B	1.60	0.063
C	2.80	0.110
D	5.40	0.213
E	2.20	0.087

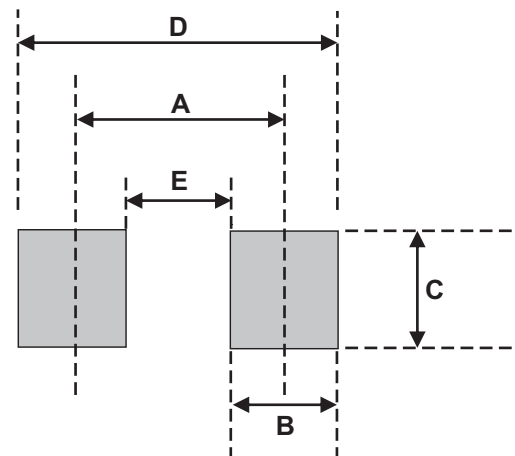

Standard Packaging

Case Type	Qty Per Reel	Reel Size
	(Pcs)	(inch)
SMA/DO-214AC	5,000	13