



PROPRIETARY NOTE
THIS SPECIFICATION IS THE PROPERTY OF BOE HF AND SHALL NOT BE REPRODUCED OR COPIED WITHOUT THE WRITTEN PERMISSION OF BOE HF AND MUST BE RETURNED TO BOE HF UPON ITS REQUEST

SPEC. NUMBER
S8-64-6A-107

PRODUCT GROUP
TFT-LCD

Rev.0

ISSUE DATE

PAGE
1 OF 44

TITLE : TV080WUM-NL0

Product Specification

Rev. 0

HEFEI BOE OPTOELECTRONICS TECHNOLOGY

 京东方 BOE	PRODUCT GROUP	REV	ISSUE DATE
	TFT- LCD PRODUCT	0	2014.8.22
SPEC. NUMBER S8-64-6A-107	SPEC. TITLE TV080WUM-NL0 Product Specification		PAGE 3 OF 44

Contents

No.	Items	Page
1.0	General Description	4
2.0	Absolute Maximum ratings	6
3.0	Electrical specifications.	7
4.0	Optical specifications.	9
5.0	Interface Connection	14
6.0	Signal Timing Specification	18
7.0	Signal Timing waveforms	21
8.0	Input Signals, Display Colors & Gray Scale of Colors	22
9.0	Power Sequence	23
10.0	Connector description	24
11.0	Mechanical Characteristics	25
12.0	Reliability Test	26
13.0	Handling & Cautions.	26
14.0	Label	27
15.0	Packing information	29
16.0	Mechanical Outline Dimension	31
17.0	UL&CB Report	32

1.0 GENERAL DESCRIPTION

1.1 Introduction

TV080WUM-NL0 is a color active matrix TFT LCD module using amorphous silicon TFT's (Thin Film Transistors) as an active switching devices. This module has a 8 inch diagonally measured active area with **WUXGA** resolutions (1200 horizontal by 1920 vertical pixel array). Each pixel is divided into RED, GREEN, BLUE dots which are arranged in vertical stripe and this module can display **16.7M** colors. The TFT-LCD panel used for this module is adapted for a low reflection and higher color type.

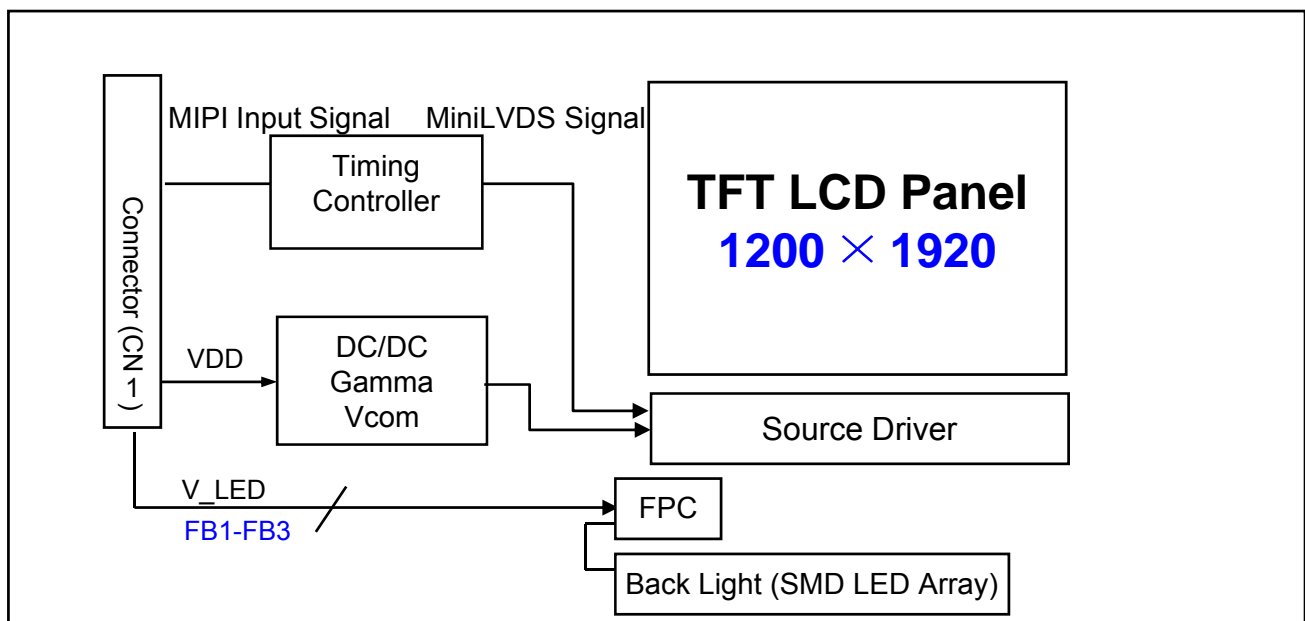

1.2 Features

- **4 Lane MIPI Interface**
- Thin and light weight
- Display 16.7M colors(**8bit**)
- High luminance and contrast ratio, low reflection and wide viewing angle
- **3.3V** for Logic Power
- RoHS Compliant



PRODUCT GROUP

REV

ISSUE DATE

TFT- LCD PRODUCT

0

2014.8.22

SPEC. NUMBER
S8-64-6A-107

SPEC. TITLE
TV080WUM-NL0 Product Specification

PAGE
5 OF 44

1.3 Application

- Tablet & Application Mini-PC (Wide Type)

1.4 General Specification

< Table 1. General Specifications >

Parameter	Specification	Unit	Remarks
Active area	107.64(H)x172.224(V)	mm	
Number of pixels	1200(H) × 1920(V)	pixels	
Pixel pitch	89.7	μm	
Pixel arrangement	Pixels RGB stripe arrangement		
Display colors	16.7M(8bits)	colors	
Display mode	Transmission mode. Normally Black		
Outline Dimension	114.6 (H)×184.1(V)×2.15 (TYP.)	mm	
Weight	80(max)	gram	
Surface Treatment	HC, 3H, (Front Polarizer)		
Back-light	Bottom edge side, 3-LED Lighting Bar Type		7S3P LED Array



PRODUCT GROUP

REV

ISSUE DATE

TFT- LCD PRODUCT

0

2014.8.22

SPEC. NUMBER
S8-64-6A-107

SPEC. TITLE
TV080WUM-NL0 Product Specification

PAGE
6 OF 44

2.0 ABSOLUTE MAXIMUM RATINGS

The followings are maximum values which, if exceed, may cause faulty operation or damage to the unit. The operational and non-operational maximum voltage and current values are listed in Table 2.

< Table 2. LCD Module Electrical Specifications > [Ta =25±2 °C]

Parameter	Symbol	Min.	Max.	Unit	Remarks
Power Supply Voltage (LCD Module)	V _{DD}	-0.3	5	V	
LED Forward Voltage of every LED string	V _{LED}	-0.3	22.4	V	
LED Forward Current of every LED string	I _{LED}	-	30	mA	
LED string Reverse Voltage	V _R	-	2	V	
Operating Temperature	T _{OP}	-20	+60	°C	1)
Storage Temperature	T _{ST}	-20	+60	°C	

Note : 1) Temperature and relative humidity range are shown in the figure below.
Wet bulb temperature should be 39 °C max. and no condensation of water.

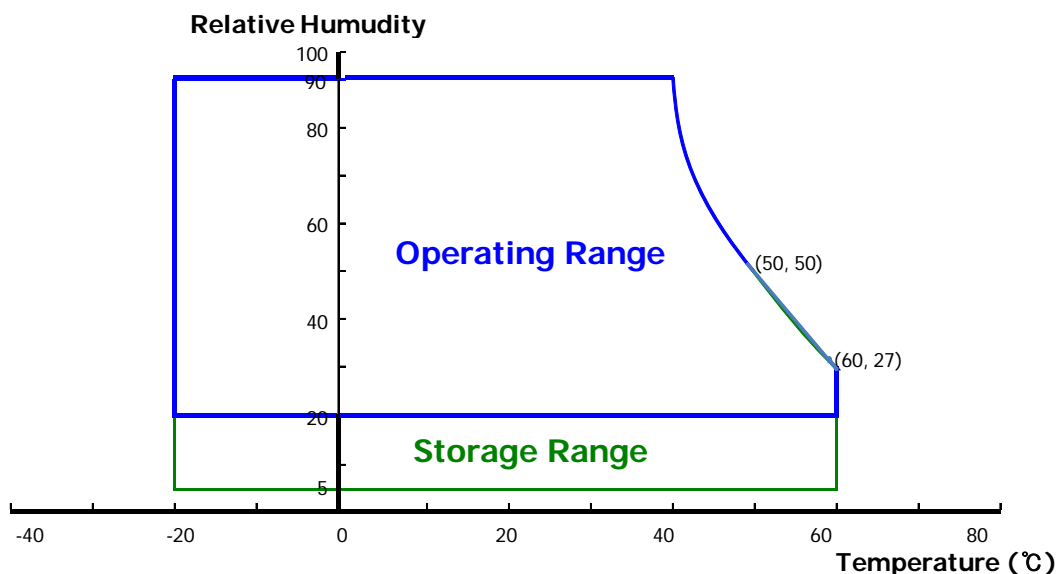

 京东方 BOE	PRODUCT GROUP	REV	ISSUE DATE
	TFT- LCD PRODUCT	0	2014.8.22
SPEC. NUMBER S8-64-6A-107	SPEC. TITLE TV080WUM-NL0 Product Specification		PAGE 7 OF 44

3.0 ELECTRICAL SPECIFICATIONS

3.1 TFT LCD Module

< Table 3. LCD Module Electrical Specifications > [Ta =25±2 °C]

Parameter	Symbol	Values			Unit	Notes
		Min	Typ.	Max		
Power Supply Input Voltage	V _{DD}	3.0	3.3	3.6	V	Note 1
Power Supply Current	I _{DD}	-	115	121	mA	Note 1
LED Forward Voltage of every LED string	V _{LED}	-	21	22.4	V	Note 2
LED Forward Current of every LED string	I _{LED}	-	21	-	mA	Note 2
Power Consumption	P _D	-	0.38	0.5(RGB) 0.4(W)	W	Note 3
	P _{BL}	-	1.32	1.41	W	w/o Driver
	P _{Total}	-	1.7	1.81	W	

Notes : 1. The specified current and power consumption are under the conditions at VDD =3.3V, T = 25° C, and fv = 60 Hz, at white pattern (TYP);

The specified current and power consumption are under the conditions at VDD = 3.3V, T = 25° C, and fv = 60 Hz, at R/G/B pattern (MAX)

2. Calculated value for reference (VLED X ILED)



PRODUCT GROUP

REV

ISSUE DATE

TFT- LCD PRODUCT

0

2014.8.22

SPEC. NUMBER
S8-64-6A-107

SPEC. TITLE
TV080WUM-NL0 Product Specification

PAGE
8 OF 44

3.2 Back-light Unit

< Table 4. LED Driving guideline specifications >

Ta=25+/-2°C

Parameter		Min.	Typ.	Max.	Unit	Remarks
LED Forward Voltage	V _F	-	3	3.2	V	-
LED Forward Current	I _F	-	21	-	mA	-
LED Power Consumption	P _{LED}	-	1.32	1.41	W	Note 1
LED Life-Time	N/A	15,000	-	-	Hour	IF = 21mA Note 2
LED Forward Voltage of every LED string	V _{LED}	-	21	22.4	V	
LED Forward Current of every LED string	I _{LED}	-	21	-	mA	
PWMIN Control Level	PWMIN High Level	V _{PMIH}	0.7x VDD	-	VDD	V
	PWMIN Low Level	V _{PMIL}	0.0	-	0.3xV DD	V
PWMOUT Control Level	PWMOUT High Level	V _{PMOH}	VDD- 0.4	-	-	V
	PWMOUT Low Level	V _{PMOL}	-	-	GND +0.4	V
PWM Control Frequency	F _{PWM}	0.1	-	30	KHz	
PWM duty Ratio	Duty	5%	-	100%	%	

Notes : 1. Calculator Value for reference $V_{LED} \times I_{LED} \times 21 = P_{LED}$

2. The LED Life-time define as the estimated time to 50% degradation of initial luminous.

	PRODUCT GROUP	REV	ISSUE DATE
	TFT- LCD PRODUCT	0	2014.8.22
SPEC. NUMBER S8-64-6A-107	SPEC. TITLE TV080WUM-NL0 Product Specification		PAGE 9 OF 44

4.0 OPTICAL SPECIFICATION

4.1 Overview

The test of Optical specifications shall be measured in a dark room (ambient luminance \leq 1lux and temperature = $25\pm 2^{\circ}\text{C}$) with the equipment of Luminance meter system (Goniometer system and TOPCON BM-5) and test unit shall be located at an approximate distance 50cm from the LCD surface at a viewing angle of θ and Φ equal to 0° . While scanning θ and/or Φ , the center of the measuring spot on the Display surface shall stay fixed. The backlight should be operating for 30 minutes prior to measurement. VDD shall be $3.3\pm 0.3\text{V}$ at 25°C . Optimum viewing angle direction is 6 'clock.

4.2 Optical Specifications

<Table 5. Optical Specifications>

Parameter		Symbol	Condition	Min.	Typ.	Max.	Unit	Remark		
Viewing Angle range	Horizontal	Θ_3	CR > 10	80	85	-	Deg.	Note 1		
		Θ_9		80	85	-	Deg.			
	Vertical	Θ_{12}		80	85	-	Deg.			
		Θ_6		80	85	-	Deg.			
Color Gamut			55	60	-	%				
Luminance Contrast ratio		CR	$\Theta = 0^{\circ}$	700	900	-		Note 2		
Luminance of White	center Points	Y_w	$\Theta = 0^{\circ}$	330	390	-	cd/m ²	Note 3		
White Luminance uniformity	5 Points	ΔY_5		80	-	-		Note 4		
White Luminance uniformity	13 Points	ΔY_{13}		67	-	-		Note 4		
White Chromaticity		W_x	$\Theta = 0^{\circ}$	Typ.	0.300	Typ.		Note 5		
		W_y		-0.03	0.320				+0.03	
Reproduction of color	Red	R_x	$\Theta = 0^{\circ}$	Typ.	0.629	Typ.				
		R_y			0.343					
	Green	G_x			-0.03				0.327	+0.03
		G_y			0.599					
	Blue	B_x			0.150					
		B_y			0.085					
Response Time (Rising + Falling)		T_{RT}	$T_a = 25^{\circ}\text{C}$ $\Theta = 0^{\circ}$	-	25	-	ms	Note 6		
Gamma Scale				2.0	2.2	2.4				
Cross Talk		CT	$\Theta = 0^{\circ}$	-	-	2.0	%	Note 7		

 京东方 BOE	PRODUCT GROUP	REV	ISSUE DATE
	TFT- LCD PRODUCT	0	2014.8.22
SPEC. NUMBER S8-64-6A-107	SPEC. TITLE TV080WUM-NL0 Product Specification		PAGE 10 OF 44

Notes : 1. Viewing angle is the angle at which the contrast ratio is greater than 10. The viewing angles are determined for the horizontal or 3, 9 o'clock direction and the vertical or 6, 12 o'clock direction with respect to the optical axis which is normal to the LCD surface (see FIGURE 1).

2. Contrast measurements shall be made at viewing angle of $\Theta = 0$ and at the center of the LCD surface. Luminance shall be measured with all pixels in the view field set first to white, then to the dark (black) state . (see FIGURE 1) Luminance Contrast Ratio (CR) is defined mathematically.

$$CR = \frac{\text{Luminance when displaying a white raster}}{\text{Luminance when displaying a black raster}}$$

3. Center Luminance of white is defined as luminance values of 5point average across the LCD surface. Luminance shall be measured with all pixels in the view field set first to white. This measurement shall be taken at the locations shown in FIGURE 2 for a total of the measurements per display, the LED current is set at 20mA.
4. The White luminance uniformity on LCD surface is then expressed as : $\Delta Y = \text{Minimum Luminance of 5 (13)points} / \text{Maximum Luminance of 5(13) (points}$ (see FIGURE 2).
5. The color chromaticity coordinates specified in Table 5 shall be calculated from the spectral data measured with all pixels first in red, green, blue and white. Measurements shall be made at the center of the panel.
6. The electro-optical response time measurements shall be made as FIGURE 3 by switching the "data" input signal ON and OFF. The times needed for the luminance to change from 10% to 90% is Tr, and 90% to 10% is Td.
7. Cross-Talk of one area of the LCD surface by another shall be measured by comparing the luminance (YA) of a 25mm diameter area, with all display pixels set to a gray level, to the luminance (YB) of that same area when any adjacent area is driven dark. (See FIGURE 4).

4.3 Optical measurements

Figure 1. Measurement Set Up

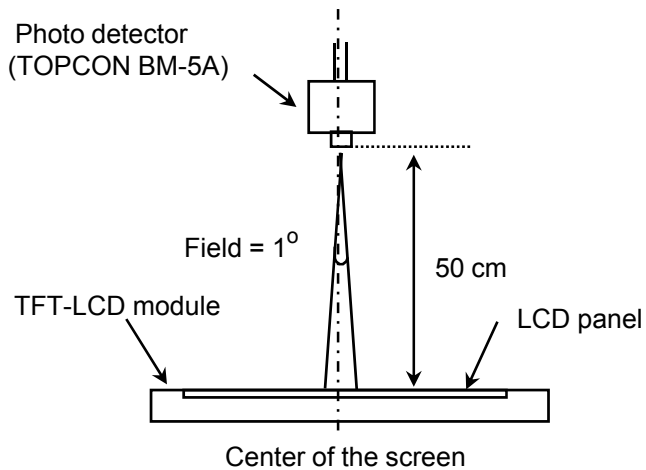

View angel range measurement setup

Figure 2. White Luminance and Uniformity Measurement Locations (5 points)

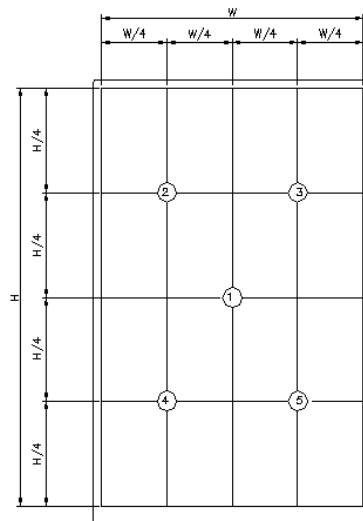

Center Luminance of white is defined as luminance values of center 5 points across the LCD surface. Luminance shall be measured with all pixels in the view field set first to white. This measurement shall be taken at the locations shown in FIGURE 2 for a total of the measurements per display.

The White luminance uniformity on LCD surface is then expressed as : $\Delta Y5 = \text{Minimum Luminance of 5 points} / \text{Maximum Luminance of 5 points}$ (see FIGURE 2).

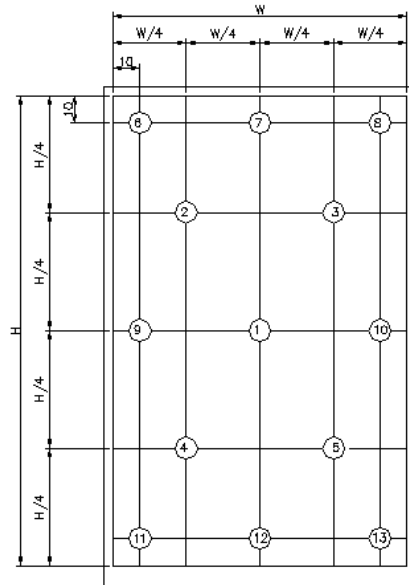
Figure 3. Uniformity Measurement Locations (13 points)

The White luminance uniformity on LCD surface is then expressed as : $\Delta Y_{13} = \text{Minimum Luminance of 13 points} / \text{Maximum Luminance of 13 points}$ (see FIGURE 3).

The White luminance uniformity of 5 point is the same test method as 13 point using FIGURE 2.

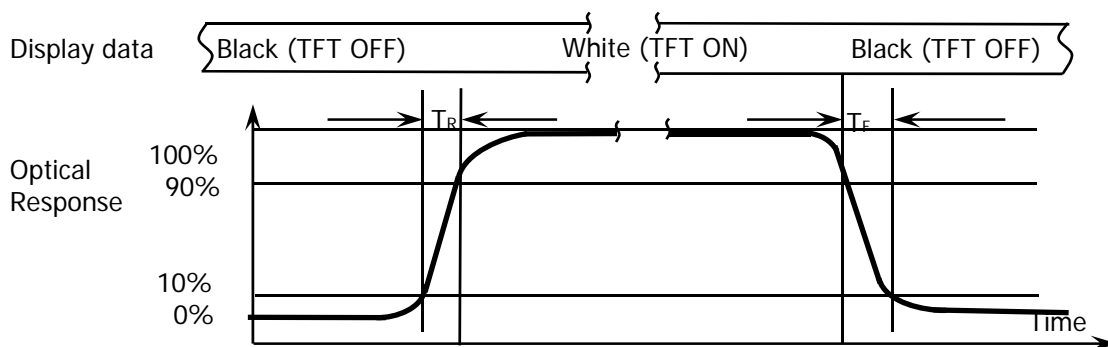
Figure 4. Response Time Testing

The electro-optical response time measurements shall be made as shown in FIGURE 4 by switching the “data” input signal ON and OFF. The times needed for the luminance to change from 10% to 90% is T_r and 90% to 10% is T_d .

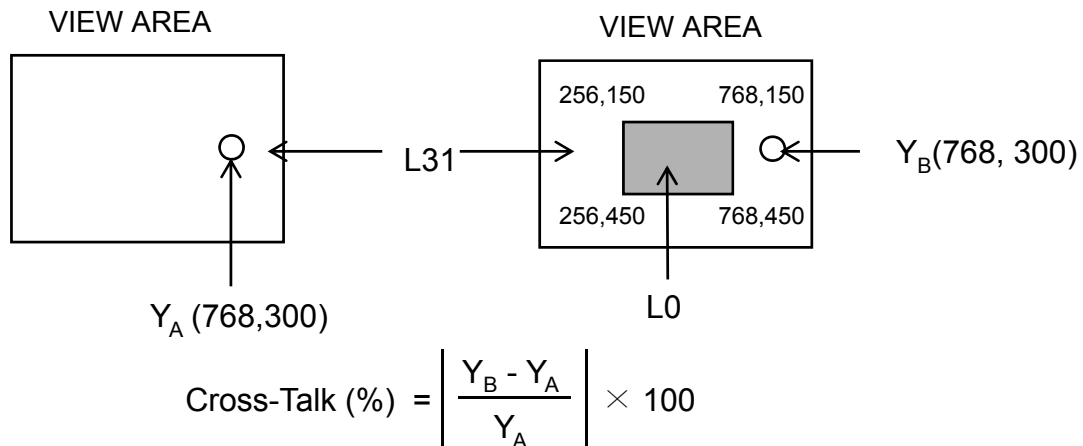
Figure 5. Cross Modulation Test Description

Where:

Y_A = Initial luminance of measured area (cd/m²)

Y_B = Subsequent luminance of measured area (cd/m²)

The location measured will be exactly the same in both patterns.

Cross-Talk of one area of the LCD surface by another shall be measured by comparing the luminance (Y_A) of a 25mm diameter area, with all display pixels set to a gray level, to the luminance (Y_B) of that same area when any adjacent area is driven dark (Refer to FIGURE 5).



PRODUCT GROUP

REV

ISSUE DATE

TFT- LCD PRODUCT

0

2014.8.22

SPEC. NUMBER
S8-64-6A-107

SPEC. TITLE
TV080WUM-NL0 Product Specification

PAGE
14 OF 44

5.0 INTERFACE CONNECTION.

5.1 Electrical Interface Connection

The electronics interface connector is [FH26W-39S-0.3SHW\(05\)](#)

The connector interface pin assignments are listed in Table 6.

<Table 5. 1. Pin Assignments for the Interface Connector>

Terminal	Symbol	Functions
Pin No.	Symbol	Description
1	VCC	Power Supply, 3.3V
2	VCC	Power Supply, 3.3V
3	VCC	Power Supply, 3.3V
4	VCC	Power Supply, 3.3V
5	NC	NC
6	NC	NC
7	LED_PWMIN	PWM input
8	LED_PWMOUT	PWM output
9	NC	BOE use
10	NC	BOE use
11	GND	Ground
12	D0+	MIPI Input Data Pair D0+
13	D0-	MIPI Input Data Pair D0-
14	GND	Ground
15	D1+	MIPI Input Data Pair D1+
16	D1-	MIPI Input Data Pair D1-
17	GND	Ground
18	CLK+	MIPI Input Clock Pair CLK+
19	CLK-	MIPI Input Clock Pair CLK-
20	GND	Ground

<Table 5.2. Pin Assignments for the Interface Connector>

Terminal	Symbol	Functions
Pin No.	Symbol	Description
21	D2+	MIPI Input Data Pair D2+
22	D2-	MIPI Input Data Pair D2-
23	GND	Ground
24	D3+	MIPI Input Data Pair D3+
25	D3-	MIPI Input Data Pair D3-
26	GND	Ground
27	GND	Ground
28	ID	ID PIN (pull down to GND with 0ohm,for BOE)
29	STBYB	Standby mode select
30	LB1	LED-
31	LB2	LED-
32	LB3	LED-
33	NC	NC
34	NC	NC
35	NC	NC
36	NC	NC
37	NC	NC
38	LED_vout	LED+
39	LED_vout	LED+

Note 1 :ID PIN (for GND)

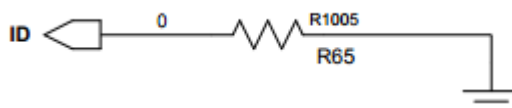



PRODUCT GROUP

REV

ISSUE DATE

TFT- LCD PRODUCT

0

2014.8.22

SPEC. NUMBER
S8-64-6A-107

SPEC. TITLE
TV080WUM-NL0 Product Specification

PAGE
16 OF 44

5.2 Data Input Format

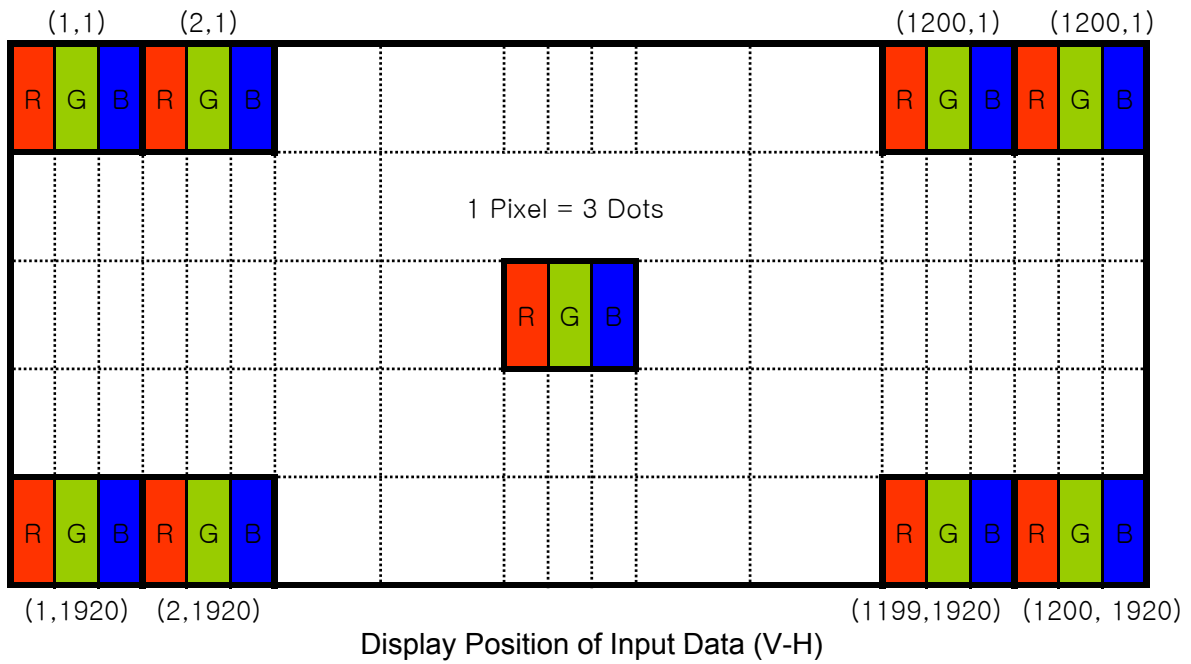



PRODUCT GROUP

REV

ISSUE DATE

TFT- LCD PRODUCT

0

2014.8.22

SPEC. NUMBER
S8-64-6A-107

SPEC. TITLE
TV080WUM-NL0 Product Specification

PAGE
17 OF 44

6.0 SIGNAL TIMING SPECIFICATION

6.1 Signal timing

ITEM		SYMBOL	min	typ	max	UNIT	
LCD	Frame Rate	-	-	60	-	Hz	
	Pixels Rate	-	156.8	156.8	159.9	MHz	
Timing	DCLK	Frequency	fCLK	490	490	498	MHz
		Period	Tclk	2.01	2.04	2.04	ns
	Horizontal	Horizontal total time	tHP	1343	1343	1366	t _{CLK}
		Horizontal Active time	tHadr	1200			t _{CLK}
		Horizontal Pulse Width	tHsync	1	1	1	t _{CLK}
		Horizontal Back Porch	tHBP	32	32	32	t _{CLK}
		Horizontal Front Porch	tHFP	110	110	133	t _{CLK}
	Vertical	Vertical total time	tvp	1946	1946	1951	t _H
		Vertical Active time	tVadr	1920			t _H
		Vertical Pulse Width	tVsync	1	1	1	t _H
		Vertical Back Porch	tVBP	14	14	14	t _H
		Vertical Front Porch	tVFP	11	11	16	t _H
	Differential Swing		VDswing	400	500	-	mV
	Bit Rate		TX SPD (MBPS)	980	980	995	Mbps
	Pixel Fomat			-	24	-	Data bit/pixel
Lane			-	4	-	Lane	

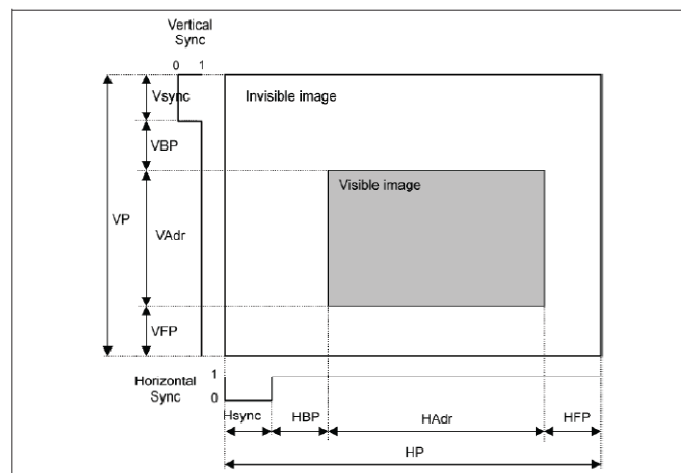

6.2 MIPI Rx Interface Timing Parameter

The specification of the MIPI Rx interface timing parameter is shown in Table 8.

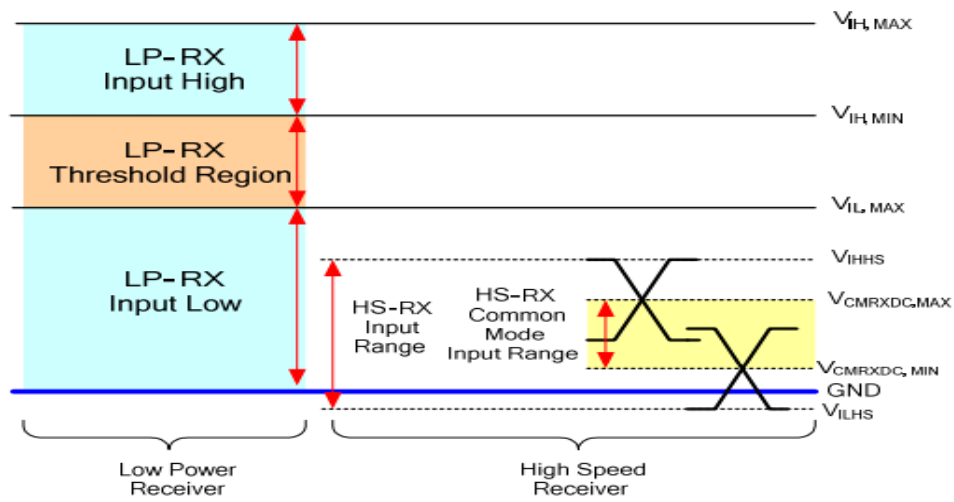

<Table 8. MIPI Rx Interface Timing Specification>

Item	Parameter	Min.	Typ.	Max.	Unit	
HS_RX	Common-mode voltage HS receive mode	VCMRX(DC)	155	—	330	mV
	Differential input high threshold	VIDTH	—	—	70	mV
	Differential input low threshold	VIDTL	70	—	—	mV
	Single-ended input high voltage	VIHHS	—	—	460	mV
	Single-ended input low voltage	VILHS	-40	—	—	mV
	Differential input impedance	ZID	60	75	95	Ω
LP_RX	Logic 1 input voltage	VIH	1100	1200	1300	mV
	Logic 0 input voltage. not in ULPState	VIL	-150	—	150	mV



PRODUCT GROUP

REV

ISSUE DATE

TFT- LCD PRODUCT

0

2014.8.22

SPEC. NUMBER
S8-64-6A-107

SPEC. TITLE
TV080WUM-NL0 Product Specification

PAGE
19 OF 44

7.0 SIGNAL TIMING WAVEFORMS OF INTERFACE SIGNAL

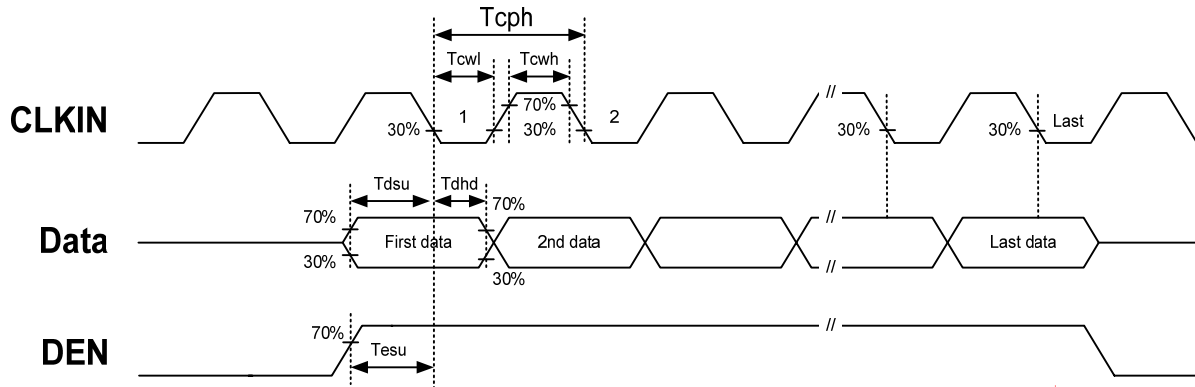



PRODUCT GROUP

REV

ISSUE DATE

TFT- LCD PRODUCT

0

2014.8.22

SPEC. NUMBER
S8-64-6A-107

SPEC. TITLE
TV080WUM-NL0 Product Specification

PAGE
20 OF 44

8.0 INPUT SIGNALS, BASIC DISPLAY COLORS & GRAY SCALE OF COLORS

Color & Gray Scale		Input Data Signal																							
		Red Data								Green Data						Blue Data									
		R7	R6	R5	R4	R3	R2	R1	R0	G7	G6	G5	G4	G3	G2	G1	G0	B7	B6	B5	B4	B3	B2	B1	B0
Basic Colors	Black	0	0	0	0	0	0	0	0	0	0	0	0	0	0	0	0	0	0	0	0	0	0	0	0
	Blue	0	0	0	0	0	0	0	0	0	0	0	0	0	0	0	0	1	1	1	1	1	1	1	1
	Green	0	0	0	0	0	0	0	0	1	1	1	1	1	1	1	1	0	0	0	0	0	0	0	0
	Cyan	0	0	0	0	0	0	0	0	1	1	1	1	1	1	1	1	1	1	1	1	1	1	1	1
	Red	1	1	1	1	1	1	1	1	0	0	0	0	0	0	0	0	0	0	0	0	0	0	0	0
	Magenta	1	1	1	1	1	1	1	1	0	0	0	0	0	0	0	0	1	1	1	1	1	1	1	1
	Yellow	1	1	1	1	1	1	1	1	1	1	1	1	1	1	1	1	0	0	0	0	0	0	0	0
	White	1	1	1	1	1	1	1	1	1	1	1	1	1	1	1	1	1	1	1	1	1	1	1	1
Gray Scale of Red	Black	0	0	0	0	0	0	0	0	0	0	0	0	0	0	0	0	0	0	0	0	0	0	0	
	△	0	0	0	0	0	0	0	1	0	0	0	0	0	0	0	0	0	0	0	0	0	0	0	
	Darker	0	0	0	0	0	0	1	0	0	0	0	0	0	0	0	0	0	0	0	0	0	0	0	
	△	↑								↑						↑									
	▽	↓								↓						↓									
	Brighter	1	1	1	1	1	1	0	1	0	0	0	0	0	0	0	0	0	0	0	0	0	0	0	0
	▽	1	1	1	1	1	1	1	0	0	0	0	0	0	0	0	0	0	0	0	0	0	0	0	0
	Red	1	1	1	1	1	1	1	1	0	0	0	0	0	0	0	0	0	0	0	0	0	0	0	0
Gray Scale of Green	Black	0	0	0	0	0	0	0	0	0	0	0	0	0	0	0	0	0	0	0	0	0	0	0	
	△	0	0	0	0	0	0	0	0	0	0	0	0	0	0	0	1	0	0	0	0	0	0	0	
	Darker	0	0	0	0	0	0	0	0	0	0	0	0	0	0	1	0	0	0	0	0	0	0	0	
	△	↑								↑						↑									
	▽	↓								↓						↓									
	Brighter	0	0	0	0	0	0	0	0	1	1	1	1	1	1	0	1	0	0	0	0	0	0	0	0
	▽	0	0	0	0	0	0	0	0	1	1	1	1	1	1	1	0	0	0	0	0	0	0	0	0
	Green	0	0	0	0	0	0	0	0	1	1	1	1	1	1	1	1	0	0	0	0	0	0	0	0
Gray Scale of Blue	Black	0	0	0	0	0	0	0	0	0	0	0	0	0	0	0	0	0	0	0	0	0	0	0	
	△	0	0	0	0	0	0	0	0	0	0	0	0	0	0	0	0	0	0	0	0	0	0	1	
	Darker	0	0	0	0	0	0	0	0	0	0	0	0	0	0	0	0	0	0	0	0	0	0	1	0
	△	↑								↑						↑									
	▽	↓								↓						↓									
	Brighter	0	0	0	0	0	0	0	0	0	0	0	0	0	0	0	1	1	1	1	1	1	1	0	1
	▽	0	0	0	0	0	0	0	0	0	0	0	0	0	0	0	1	1	1	1	1	1	1	1	0
	Blue	0	0	0	0	0	0	0	0	0	0	0	0	0	0	0	1	1	1	1	1	1	1	1	1
Gray Scale of White	Black	0	0	0	0	0	0	0	0	0	0	0	0	0	0	0	0	0	0	0	0	0	0	0	
	△	0	0	0	0	0	0	0	1	0	0	0	0	0	0	0	1	0	0	0	0	0	0	1	
	Darker	0	0	0	0	0	0	1	0	0	0	0	0	0	0	1	0	0	0	0	0	0	0	1	0
	△	↑								↑						↑									
	▽	↓								↓						↓									
	Brighter	1	1	1	1	1	1	0	1	1	1	1	1	1	1	0	1	1	1	1	1	1	1	0	1
	▽	1	1	1	1	1	1	1	0	1	1	1	1	1	1	1	0	1	1	1	1	1	1	1	0
	White	1	1	1	1	1	1	1	1	1	1	1	1	1	1	1	1	1	1	1	1	1	1	1	1



PRODUCT GROUP

REV

ISSUE DATE

TFT- LCD PRODUCT

0

2014.8.22

SPEC. NUMBER
S8-64-6A-107

SPEC. TITLE
TV080WUM-NL0 Product Specification

PAGE
21 OF 44

9.0 POWER SEQUENCE

To prevent a latch-up or DC operation of the LCD module, the power on/off sequence shall be as shown in below

Power-On/Off Timing Sequence:

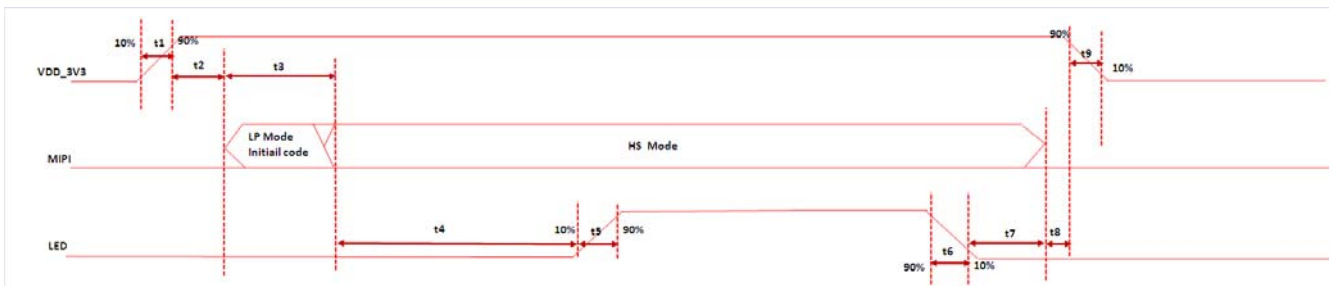

Parameter	Value				Remark
	Min.	Typ.	Max.	Unit	
t1	0.1	-	20	ms	
t2	1	-	20	ms	
t3	20	-	40	ms	
t4	200	-	-	ms	
t5	0.1	-	20	ms	
t6	0.1	-	20	ms	
t7	200	-	-	ms	
t8	0	-	20	ms	
t9	0.1	-	20	ms	

 京东方 BOE	PRODUCT GROUP	REV	ISSUE DATE
	TFT- LCD PRODUCT	0	2014.8.22
SPEC. NUMBER S8-64-6A-107	SPEC. TITLE TV080WUM-NL0 Product Specification		PAGE 22 OF 44

10.0 Connector Description

Physical interface is described as for the connector on LCM.

These connectors are capable of accommodating the following signals and will be following components.

10.1 TFT LCD Module

Connector Name /Description	For Signal Connector
Manufacturer	Hirose
Type/ Part Number	FH26W-39S-0.3SHW(05)

10.2 LED Connector

Pin No.	Symbol	For Signal Connector
1	NC	No Connection
2	LED_Vout	LED Anode Power Supply
3	LED_Vout	LED Anode Power Supply
4	NC	No Connection
5	NC	No Connection
6	FB1	LED Cathode Power Supply
7	FB2	LED Cathode Power Supply
8	FB3	LED Cathode Power Supply
9	NC	No Connection

 京东方 BOE	PRODUCT GROUP	REV	ISSUE DATE
	TFT- LCD PRODUCT	0	2014.8.22
SPEC. NUMBER S8-64-6A-107	SPEC. TITLE TV080WUM-NL0 Product Specification		PAGE 23 OF 44

11.0 MECHANICAL CHARACTERISTICS

11.1 Dimensional Requirements

FIGURE 5 shows mechanical outlines for the model TV080WUM-NL0.
Other parameters are shown in Table 9.

<Table 9. Dimensional Parameters>

Parameter	Specification	Unit
Active Area	107.64(H)x172.224(V)	mm
Number of pixels	1200(H) X1920 (V) (1 pixel = R + G + B dots)	
Pixel pitch	89.7	um
Pixel arrangement	RGB Vertical stripe	
Display colors	16.7M	
Display mode	Normally Black	
Dimensional outline	114.6 (H)×184.1(V)×2.15 (TYP.)	mm
Weight	80 (Max)	gram
Back-light	LED, Horizontal-LED Array type	

11.2 Mounting

See FIGURE 6.

11.3 Glare and Polarizer Hardness.

The surface of the LCD has an low reflection coating and hard coating to reduce scratching.

11.4 Light Leakage

There shall not be obvious visible light from the back-lighting system around the edges of the screen as seen from a distance 50cm from the screen with an overhead light level of 150lux.

 京东方 BOE	PRODUCT GROUP	REV	ISSUE DATE
	TFT- LCD PRODUCT	0	2014.8.22
SPEC. NUMBER S8-64-6A-107	SPEC. TITLE TV080WUM-NL0 Product Specification		PAGE 24 OF 44

12.0 RELIABILITY TEST

The Reliability test items and its conditions are shown in below.

<Table 10. Reliability test>

No		Conditions
1	High temperature storage test	Ta = 60 °C, 240 hrs
2	Low temperature storage test	Ta = -20 °C, 240 hrs
3	High temperature & high humidity operation test	Ta = 60 °C, 90%RH, 240 hrs power on
4	High temperature operation test	Ta = 60 °C, 240 hrs
5	Low temperature operation test	Ta = -20 °C, 240 hrs
6	Thermal shock	Ta = -40 °C ↔ 60 °C ,60hr, 50 cycle
7	High temperature & high humidity Storage test	Ta = 60 °C, 90%RH, 240 hrs power off
8	Electro-static discharge test (non-operating)	Air : 150 pF, 330Ω, ±8KV Contact : 150 pF, 330Ω, ±4 KV

13.0 HANDLING & CAUTIONS

(1) Cautions when taking out the module

- Pick the pouch only, when taking out module from a shipping package.

(2) Cautions for handling the module

- As the electrostatic discharges may break the LCD module, handle the LCD module with care. Peel a protection sheet off from the LCD panel surface as slowly as possible.
- As the LCD panel and back - light element are made from fragile glass material, impulse and pressure to the LCD module should be avoided.
- As the surface of the polarizer is very soft and easily scratched, use a soft dry cloth without chemicals for cleaning.
- Do not pull the interface connector in or out while the LCD module is operating.
- Put the module display side down on a flat horizontal plane.
- Handle connectors and cables with care.

(3) Cautions for the operation

- When the module is operating, do not lose CLK, ENAB signals. If any one of these signals is lost, the LCD panel would be damaged.
- Obey the supply voltage sequence. If wrong sequence is applied, the module would be damaged.

 京东方 BOE	PRODUCT GROUP	REV	ISSUE DATE
	TFT- LCD PRODUCT	0	2014.8.22
SPEC. NUMBER S8-64-6A-107	SPEC. TITLE TV080WUM-NL0 Product Specification		PAGE 25 OF 44

(4) Cautions for the atmosphere

- Dew drop atmosphere should be avoided.
- Do not store and/or operate the LCD module in a high temperature and/or humidity atmosphere. Storage in an electro-conductive polymer packing pouch and under relatively low temperature atmosphere is recommended.

(5) Cautions for the module characteristics

- Do not apply fixed pattern data signal to the LCD module at product aging.
- Applying fixed pattern for a long time may cause image sticking.

(6) Other cautions

- Do not disassemble and/or re-assemble LCD module.
- Do not re-adjust variable resistor or switch etc.
- When returning the module for repair or etc., Please pack the module not to be broken. We recommend to use the original shipping packages.

14.0 LABEL

(1) Product label



序号号	1	2	3	4	5	6	7	8	9	10	11	12	13	14	15	16	17
代码	4	F	P	3	1	2	7	3	8	5	0	0	0	1	E	E	J
描述	GBN代码		等级	B3	年份	月	FG Code后四位				序列号						

 京东方 BOE	PRODUCT GROUP	REV	ISSUE DATE
	TFT- LCD PRODUCT	0	2014.8.22
SPEC. NUMBER S8-64-6A-107	SPEC. TITLE TV080WUM-NL0 Product Specification		PAGE 26 OF 44

(2) Box label

Label Size: 110 mm (L) × 56 mm (W)

Contents

Model: TV080WUM-NL0

Q`ty: Module Q`ty in one box

Serial No.: Box Serial No. See next figure for detail description.

Date: Packing Date

Internal use of Product

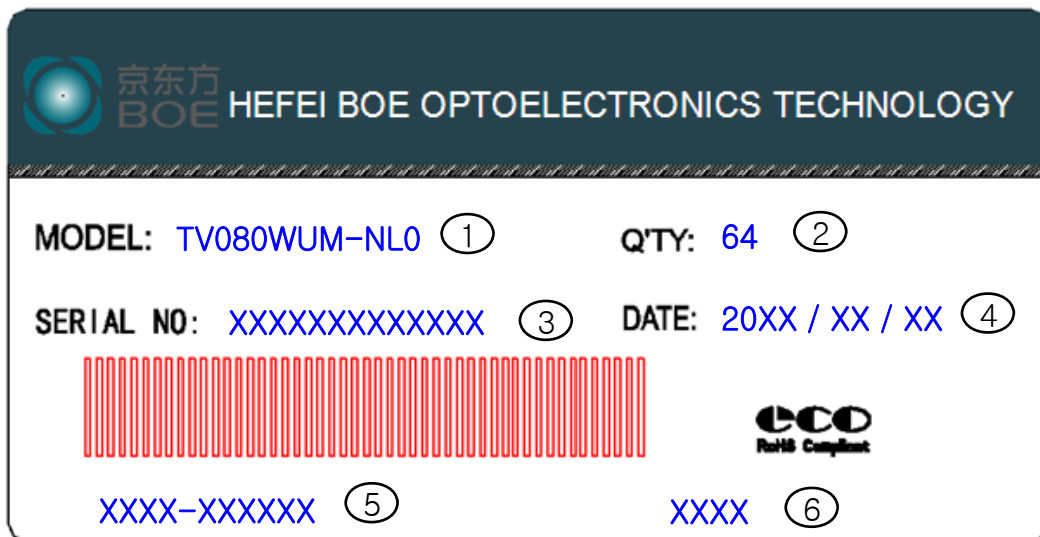

1. FG-CODE
2. Box 产品数量
3. Box ID, 编码规则如下
4. Box Packing 日期
5. 产品物料号(客户端)
6. FG-CODE 后四位

序列号	1	2	3	4	5	6	7	8	9	10	11	12	13
代码	4	J	P	3	1	2	7	0	0	0	1	H	D
描述	GBN代码		等级	B3	年份		月	Rev	序列号				

 京东方 BOE	PRODUCT GROUP	REV	ISSUE DATE
	TFT- LCD PRODUCT	0	2014.8.22
SPEC. NUMBER S8-64-6A-107	SPEC. TITLE TV080WUM-NL0 Product Specification		PAGE 27 OF 44

15.0 PACKING INFORMATION

15.1 Packing order

- 将 4pcs MDL 平放入Tray
每MDL 上放置EPE Spacer
- 容量: 4pcs/Tray

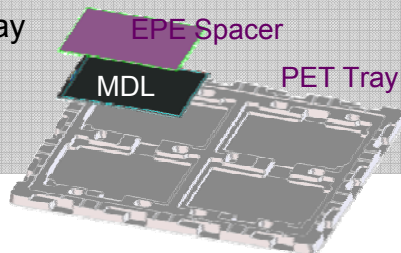

- 将17pcs PET Tray 平放入PE Bag;
- Tray 旋转180°放置, 顶部1pcs 空Tray;

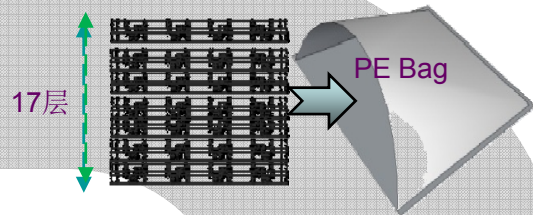

- 每个Pallet上放4层Box
1层4箱, 共计16ea Box
- Pallet外进行缠膜包装
- 容量: 1024pcs/Pallet

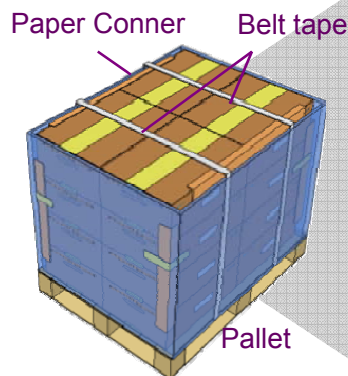

- 将PET Tray堆码后平放入Inner Box
上下放置EPE Board
- 容量 : 64pcs/Inner Box

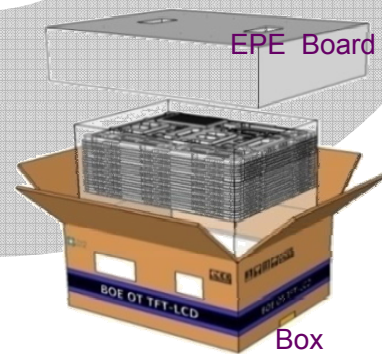

15.2 Notes

- Box Dimension: 510mm(W) x 410mm(D) x 250mm(H)
- Package Quantity in one Box: 64pcs
- Total Weight: 14kg



PRODUCT GROUP

REV

ISSUE DATE

TFT- LCD PRODUCT

0

2014.8.22

SPEC. NUMBER
S8-64-6A-107

SPEC. TITLE
TV080WUM-NL0 Product Specification

PAGE
28 OF 44

16.0 MECHANICAL OUTLINE DIMENSION

Figure 6. TFT-LCD Module Outline Dimension (Front View)

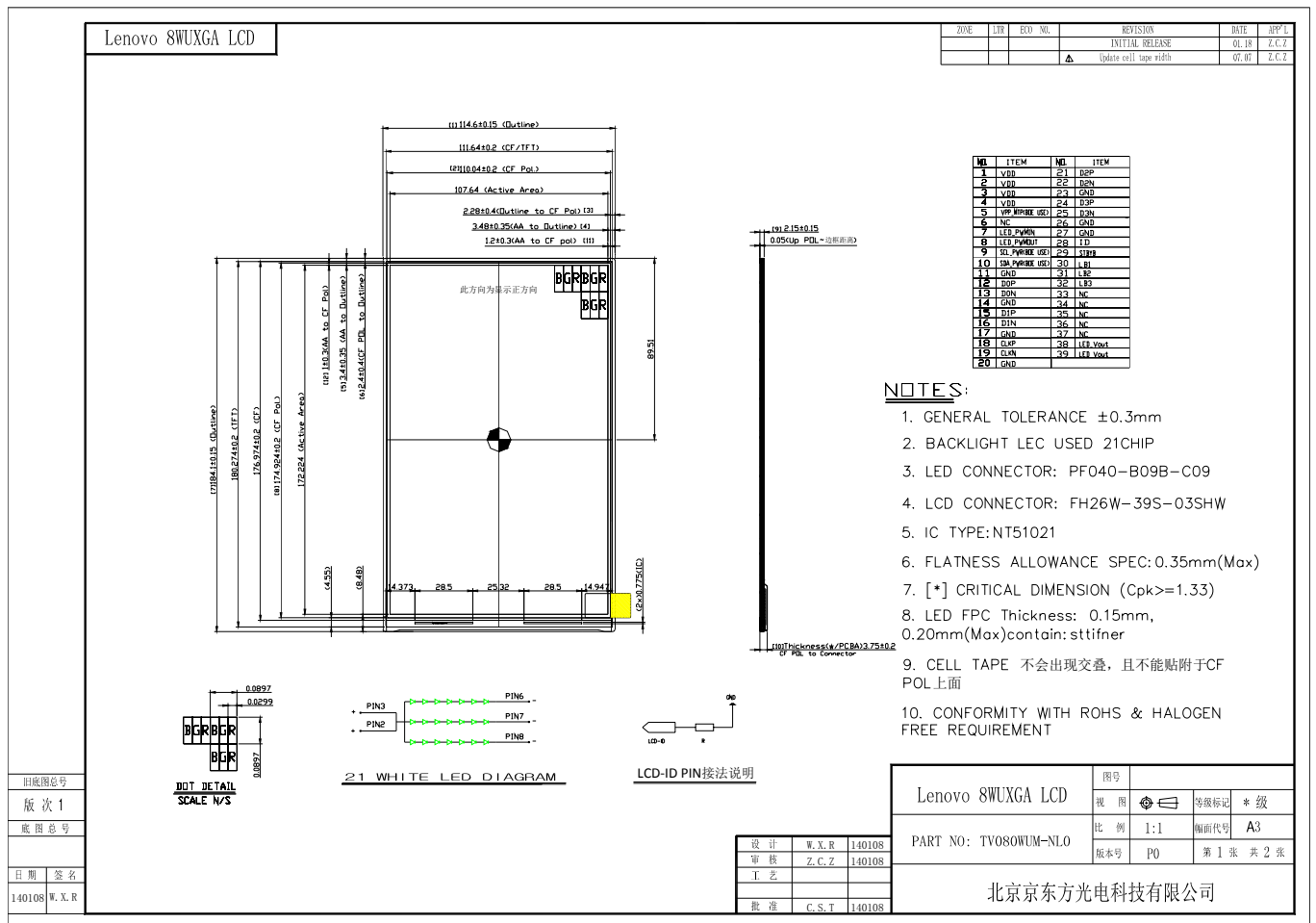

旧版图总号
版次 1
版图总号

日期 签名
140108 W.X.R

DOT DETAIL SCALE N/S

21 WHITE LED DIAGRAM

LCD-ID PIN接法说明

设计	W.X.R	140108
审核	Z.C.Z	140108
工艺		
批准	C.S.T	140108

Lenovo 8WUXGA LCD	图号	
视图		等级标记 * 级
比例 1:1	幅面代号 A3	
版本号 P0	第 1 张	共 2 张

北京京东方光电科技有限公司



PRODUCT GROUP

REV

ISSUE DATE

TFT- LCD PRODUCT

0

2014.8.22

SPEC. NUMBER
S8-64-6A-107

SPEC. TITLE
TV080WUM-NL0 Product Specification

PAGE
29 OF 44

Figure 7. TFT-LCD Module Outline Dimensions (Rear view)

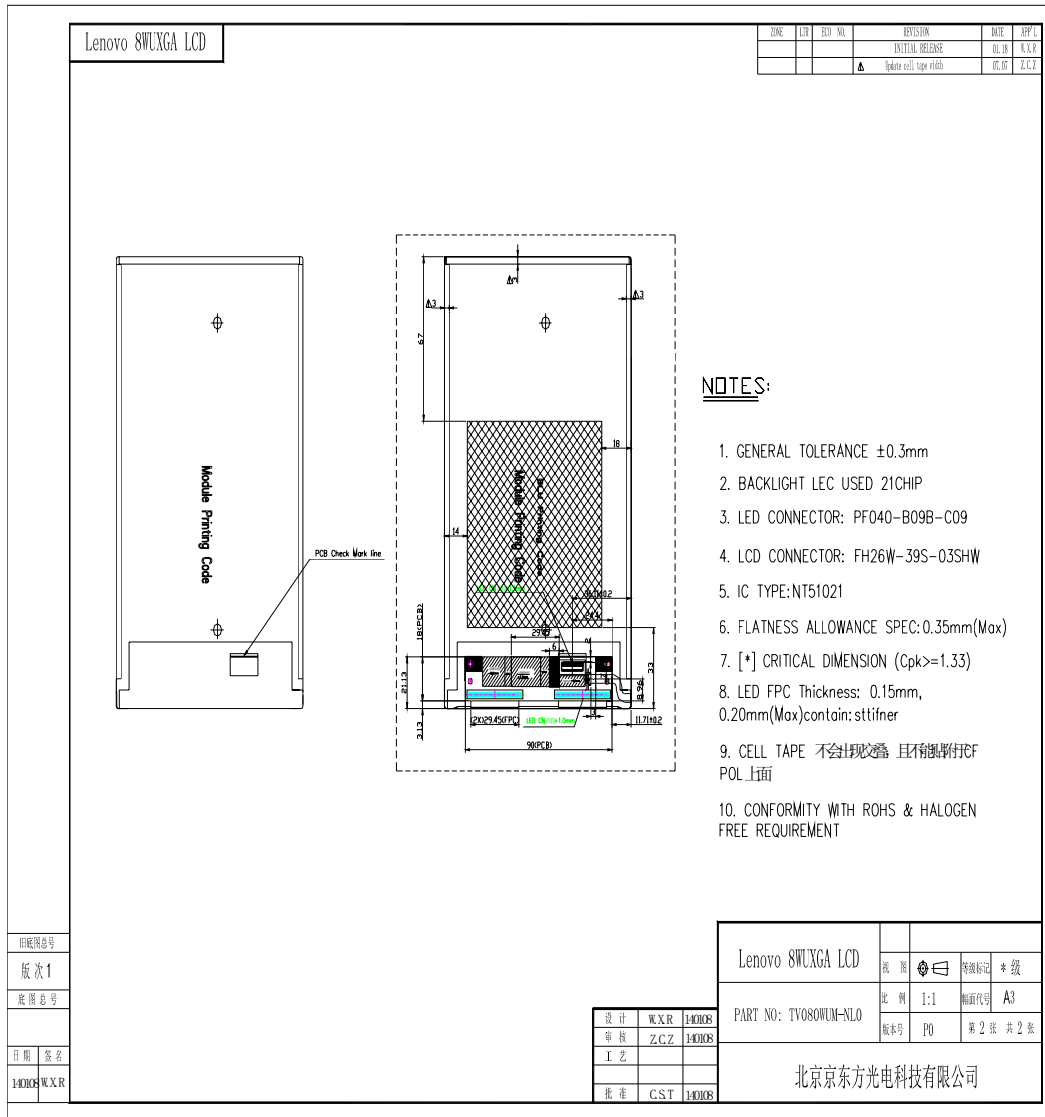

	PRODUCT GROUP	REV	ISSUE DATE
	TFT- LCD PRODUCT	0	2014.8.22
SPEC. NUMBER S8-64-6A-107	SPEC. TITLE TV080WUM-NL0 Product Specification		PAGE 30 OF 44

17.0 UL&CB Report

The product have passed UL&CB test , and the safety logo will be printed on the module Label as below.



 TV080WUM-NL0 XXXXXXXXXXXXXXXXXXXX 8S5D19A6MVTROJHFYMDXXXX
 

Issue Date: 2014-04-22 Page 1 of 8 Report Reference # E340762-A21-UL
 2014-04-28

UL TEST REPORT AND PROCEDURE

Standard:	UL 60950-1, 2nd Edition, 2011-12-19 (Information Technology Equipment - Safety - Part 1: General Requirements) CSA C22.2 No. 60950-1-07, 2nd Edition, 2011-12 (Information Technology Equipment - Safety - Part 1: General Requirements)
Certification Type:	Component Recognition
CCN:	NWQG2, NWQG8 (Information Technology Equipment Including Electrical Business Equipment)
Product:	TFT - LCD Module
Model:	***g***_*** where "*" could be any letter of "0" to "9" or "A" to "Z" or blank, denotes only non-safety related parts or name difference
Rating:	N/A
Applicant Name and Address:	HEFEI BOE OPTOELECTRONICS TECHNOLOGY CO LTD NO 2177 TONGLING RD (N) HEFEI ANHUI 230001 CHINA

This is to certify that representative samples of the products covered by this Test Report have been investigated in accordance with the above referenced Standards. The products have been found to comply with the requirements covering the category and the products are judged to be eligible for Follow-Up Service under the Indicated Test Procedure. The manufacturer is authorized to use the UL Mark on such products which comply with this Test Report and any other applicable requirements of UL LLC ("UL") in accordance with the Follow-Up Service Agreement. Only those products which properly bear the UL Mark are considered as being covered by UL's Follow-Up Service under the Indicated Test Procedure.

The applicant is authorized to reproduce the referenced Test Report provided it is reproduced in its entirety.

UL authorizes the applicant to reproduce the latest pages of the referenced Test Report consisting of the first page of the Specific Technical Criteria through to the end of the Conditions of Acceptability.

Any information and documentation involving UL Mark services are provided on behalf of UL LLC (UL) or any authorized licensee of UL.

Prepared by: Robin Chen

Reviewed by: Elicia M. Sosa

 京东方 BOE	PRODUCT GROUP	REV	ISSUE DATE
	TFT- LCD PRODUCT	0	2014.8.22
SPEC. NUMBER S8-64-6A-107	SPEC. TITLE TV080WUM-NL0 Product Specification		PAGE 31 OF 44

Supporting Documentation

The following documents located at the beginning of this Procedure supplement the requirements of this Test Report:

- A. Authorization - The Authorization page may include additional Factory Identification Code markings.
- B. Generic Inspection Instructions -
 - i. Part AC details important information which may be applicable to products covered by this Procedure. Products described in this Test Report must comply with any applicable items listed unless otherwise stated in the body of this Test Report.
 - ii. Part AE details any requirements which may be applicable to all products covered by this Procedure. Products described in this Test Report must comply with any applicable items listed unless otherwise stated in the body of each Test Report.
 - iii. Part AF details the requirements for the UL Certification Mark which is not controlled by the technical standard used to investigate these products. Products are permitted to bear only the Certification Mark(s) corresponding to the countries for which it is certified, as indicated in each Test Report.

Product Description

8 to 8.9 inch TFT - LCD Module without inverter and enclosure.

Model Differences

All models are identical to each other except for the size of TFT - LCD Cell and model designation.

Technical Considerations

- Equipment mobility : for building-in
- Connection to the mains : N/A
- Operating condition : continuous
- Access location : operator accessible
- Over voltage category (OVC) : OVC I
- Mains supply tolerance (%) or absolute mains supply values : No direct connection
- Tested for IT power systems : No
- IT testing, phase-phase voltage (V) : N/A
- Class of equipment : Class III (supplied by SELV)
- Considered current rating of protective device as part of the building installation (A) : 20
- Pollution degree (PD) : PD 2
- IP protection class : IP X0
- Altitude of operation (m) : less than 5000 m
- Altitude of test laboratory (m) : less than 2000 m
- Mass of equipment (kg) : less than 18 kg
- The product was investigated to the following additional standards: EN 60950-1:2006 + A11:2009 + A1:2010 + A12:2011 (which includes all European national differences, including those specified in this Test Report)
- The following are available from the Applicant upon request: Installation (Safety) Instructions / Manual

 京东方 BOE	PRODUCT GROUP	REV	ISSUE DATE
	TFT- LCD PRODUCT	0	2014.8.22
SPEC. NUMBER S8-64-6A-107	SPEC. TITLE TV080WUM-NL0 Product Specification		PAGE 32 OF 44

Engineering Conditions of Acceptability

For use only in or with complete equipment where the acceptability of the combination is determined by UL LLC. When installed in an end-product, consideration must be given to the following:

- The power supply terminals and/or connectors are: Suitable for factory wiring only,
- The investigated Pollution Degree is: 2
- The following end-product enclosures are required: Electrical, Mechanical, Fire

Additional Information

No tests were considered necessary, because will be conducted in end product.

The Marking Plate Label is a draft of an artwork for marking plate pending approval by National Certification Bodies and it shall not be affixed to products prior to such an approval.

Additional Standards

The product fulfills the requirements of: EN 60950-1:2006 + A11:2009 + A1:2010 + A12:2011

Markings and instructions

Clause Title	Marking or Instruction Details
Power rating - Company identification	Listee's or Recognized company's name, Trade Name, Trademark or File Number
Power rating - Model	Model Number

Special Instructions to UL Representative

N/A



	PRODUCT GROUP	REV	ISSUE DATE
	TFT- LCD PRODUCT	0	2014.8.22
SPEC. NUMBER S8-64-6A-107	SPEC. TITLE TV080WUM-NL0 Product Specification		PAGE 33 OF 44

Production-Line Testing Requirements

Electric Strength Test Special Constructions - Refer to Generic Inspection Instructions, Part AC for further information.

Model	Component	Removable Parts	Test probe location	V rms	V dc	Test Time, s
-	-	-	-	-	-	-

Earthing Continuity Test Exemptions - This test is not required for the following models:

All model in this Test Report.

Electric Strength Test Exemptions - This test is not required for the following models:

All model in this Test Report.

Electric Strength Test Component Exemptions - The following solid-state components may be disconnected from the remainder of the circuitry during the performance of this test:

--

Sample and Test Specifics for Follow-Up Tests at UL

Model	Component	Material	Test	Sample(s)	Test Specifics
-	-	-	-	-	-



京东方
BOE

PRODUCT GROUP

REV

ISSUE DATE

TFT- LCD PRODUCT

0

2014.8.22

SPEC. NUMBER

SPEC. TITLE

PAGE

S8-64-6A-107

TV080WUM-NL0 Product Specification

34 OF 44

1.5.1	TABLE: list of critical components					Pass
Object/part or Description	Manufacturer/ trademark	type/model	technical data	Product Category CCN(s)	Required Marks of Conformity	Supplement ID
1. LCD Panel	--	--	Minimum 8 inch, maximum 8.9 inch.	--	--	
2. Marking Plate Label	Interchangeable	Interchangeable	Used on suitable surface.	PGDQ2	--	
3. Connector	Interchangeable	Interchangeable	Copper Alloy Pins housed in Bodies, minimum V-2.	GMFZ2	UL	
3a. Connector (Alternate)	Interchangeable	Interchangeable	--	ECBT2 or RTRT2	UL	
4. Flexible PCB	Interchangeable	Interchangeable	Minimum V-1, minimum 105 degree C.	ZPMV2	UL	
4a. Flexible PCB (Alternate)	Interchangeable	Interchangeable	Minimum V-1, minimum 105 degree C.	ZPXK2	UL	
4b. Flexible PCB Material (Alternate)	Interchangeable	Interchangeable	Minimum V-1, minimum 105 degree C.	GMFZ2	UL	
5. PCB	Interchangeable	Interchangeable	Minimum V-1, minimum 105 degree C.	ZPMV2	UL	
6. Insulation Tape (Optional)	Interchangeable	Interchangeable	Minimum 130 degree C.	OANZ2	UL	
7. Internal Plastic Part(Reflector Sheet, Diffuser Plate, Prism Sheet)	Interchangeable	Interchangeable	Minimum HB.	GMFZ2	UL	
8. Rear Cover	--	--	Metal	--	--	
9. Bezel (Optional)	Interchangeable	Interchangeable	Minimum HB.	GMFZ2	UL	



PRODUCT GROUP

REV

ISSUE DATE

TFT- LCD PRODUCT

0

2014.8.22

SPEC. NUMBER
S8-64-6A-107

SPEC. TITLE
TV080WUM-NL0 Product Specification

PAGE
35 OF 44

<u>Type</u>	<u>Supplement Id</u>	<u>Description</u>
Photographs	3-01	TFT - LCD Module Front View
Photographs	3-02	TFT - LCD Module Rear View 1
Photographs	3-03	TFT - LCD Module Rear View 2
Photographs	3-05	Construction Specifications
Diagrams		
Schematics + PWB		
Manuals		
Miscellaneous		

 京东方 BOE	PRODUCT GROUP	REV	ISSUE DATE
	TFT- LCD PRODUCT	0	2014.8.22
SPEC. NUMBER S8-64-6A-107	SPEC. TITLE TV080WUM-NL0 Product Specification		PAGE 36 OF 44

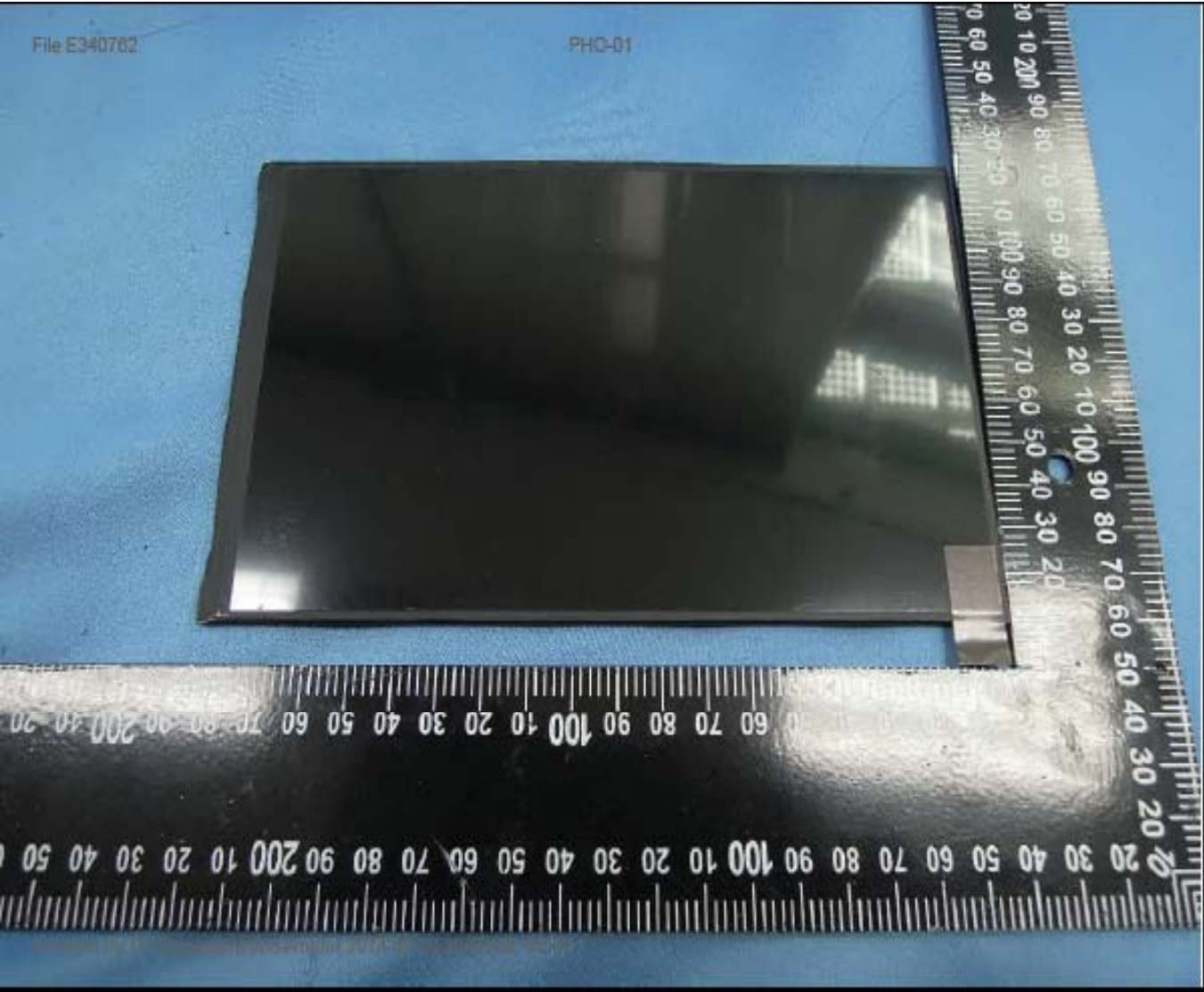

 京东方 BOE	PRODUCT GROUP	REV	ISSUE DATE
	TFT- LCD PRODUCT	0	2014.8.22
SPEC. NUMBER S8-64-6A-107	SPEC. TITLE TV080WUM-NL0 Product Specification		PAGE 37 OF 44



 京东方 BOE	PRODUCT GROUP	REV	ISSUE DATE
	TFT- LCD PRODUCT	0	2014.8.22
SPEC. NUMBER S8-64-6A-107	SPEC. TITLE TV080WUM-NL0 Product Specification		PAGE 38 OF 44





京东方
BOE

PRODUCT GROUP

REV

ISSUE DATE

TFT- LCD PRODUCT

0

2014.8.22

SPEC. NUMBER
S8-64-6A-107

SPEC. TITLE
TV080WUM-NL0 Product Specification

PAGE
39 OF 44

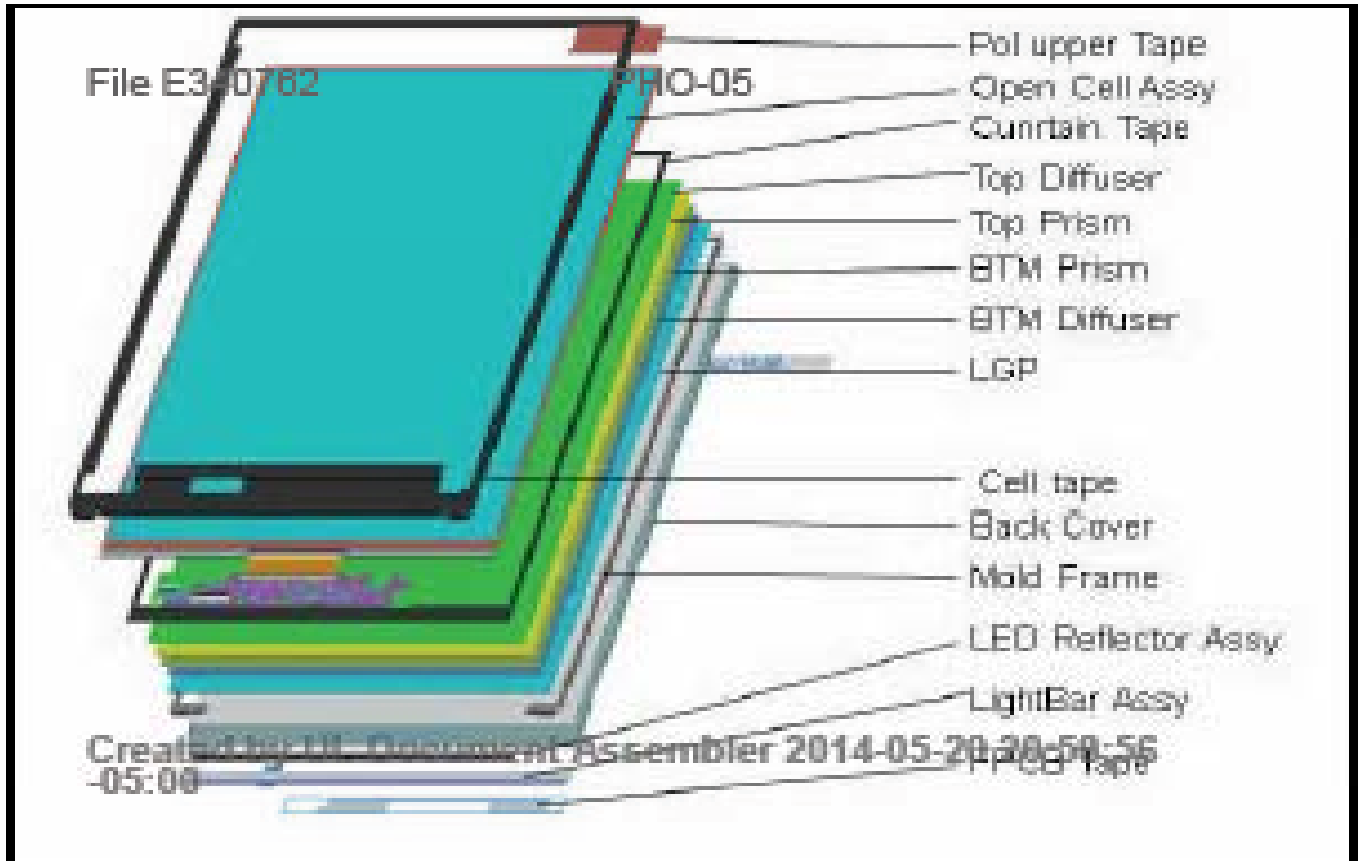



京东方
BOE

PRODUCT GROUP

REV

ISSUE DATE

TFT- LCD PRODUCT

0

2014.8.22

SPEC. NUMBER
S8-64-6A-107

SPEC. TITLE
TV080WUM-NL0 Product Specification

PAGE
40 OF 44

Test Record No. 1

-- The manufacturer submitted representative production samples of TFT LCD Module, Models ******g****_****** for examination and test.

-- Unless otherwise indicated, all tests were conducted in UL-CCIC Company Limited Suzhou Lab.

-- No test was conducted due to engineer judgment.

-- Any information and documentation involving UL Mark services are provided on behalf of UL LLC (UL) or any authorized licensee of UL.

The following supplements are provided as a part of this Test Record. NOTE: These supplements are only available to the Applicant via the CDA system.

Type	Supplement Id	Description
Attachment	2-01	CRD

 京东方 BOE	PRODUCT GROUP	REV	ISSUE DATE
	TFT- LCD PRODUCT	0	2014.8.22
SPEC. NUMBER S8-64-6A-107	SPEC. TITLE TV080WUM-NL0 Product Specification		PAGE 41 OF 44

Test Record No. 2

--No test was conducted due to correction for wrong volume.



PRODUCT GROUP

REV

ISSUE DATE

TFT- LCD PRODUCT

0

2014.8.22

SPEC. NUMBER
S8-64-6A-107

SPEC. TITLE
TV080WUM-NL0 Product Specification

PAGE
42 OF 44

CONSTRUCTION COMPLIANCE REVIEW RECORD

SAMPLE IDENTIFICATION:

Sample Card #	Date Received	Sample #	Manufacturer, Product Identification and Ratings
1857432	1857432	2014-04-16	HEFEI BOE OPTOELECTRONICS TECHNOLOGY CO LTD, TFT LCD module, Model: ***g***.***, where *** could be any letter of "0" to "9" or "A" to "Z" or blank, denotes only non-safety related parts or name difference

[X] Indications of compliance apply to all samples identified with specific indications of compliance included for construction differences of the different samples.

MEASUREMENT INSTRUMENT INFORMATION: (Ex. Micrometer, Callipers, Comparator)

Inst. ID #	Instrument Type	Function/Range	Last Cal. Date	Next Cal. Date
N/A	N/A	N/A	N/A	N/A

[] Measurement instrument information is recorded on UL's Laboratory Project Management (LPM) database. (This statement may be selected only if CRDs are completed at a UL facility)

The following additional information is required when using client's or rented equipment, or when a UL ID Number for an instrument number is not used. The Inst. ID # below corresponds to the Inst. ID # above.

Inst. ID #	Make / Model / Serial Number / Asset No.
N/A	N/A

CONSTRUCTION COMPLIANCE REVIEW:

The sample was reviewed for compliance with the construction requirements in the standard(s) indicated below and a complete record including measurements to support compliance with those requirements is detailed in Report Reference Number E340762-A21

- CSA C22.2 NO. 60950-1-07-CAN/CSA INFORMATION TECHNOLOGY EQUIPMENT SAFETY PART 1: GENERAL REQUIREMENTS - Edition 2 - Revision Date 2011/12/19
- UL 60950-1 INFORMATION TECHNOLOGY EQUIPMENT - SAFETY - PART 1: GENERAL REQUIREMENTS - Edition 2 - Revision Date 2011/12/19

Standard(s):

- UL 60950-1, 2nd Edition, 2011-12-19 (Information Technology Equipment - Safety - Part 1: General Requirements); CSA C22.2 No. 60950-1-07, 2nd Edition, 2011-12 (Information Technology Equipment - Safety - Part 1: General Requirements); IEC 60950-1 INFORMATION TECHNOLOGY EQUIPMENT -- SAFETY. PT. 1, GENERAL REQUIREMENTS - Edition 2.2 - Revision Date 2013/08/01