

Product Specification

**SPECIFICATION  
FOR  
APPROVAL**

- ( ) Preliminary Specification
- (●) Final Specification

<b>Title</b>	Customer Approval Sheet for Lenovo
--------------	------------------------------------

Customer	Lenovo
Part Number	SD19A6N5T8

SUPPLIER	BOE
MODEL	TV080WXM-NL0
Version	Ex. 1.0

SIGNATURE	DATE
 Signed by Lenovo _____ /	_____ /
Signed by Lenovo _____ /	_____ /
Please return 1 copy for your confirmation with your signature and comments.	

APPROVED BY	DATE
蔡斯特 _____	20150327 _____
<b>REVIEWED BY</b>	
张言萍 _____	20150327 _____





Product Specification

1-1. GENERAL DESCRIPTION

Block Diagram

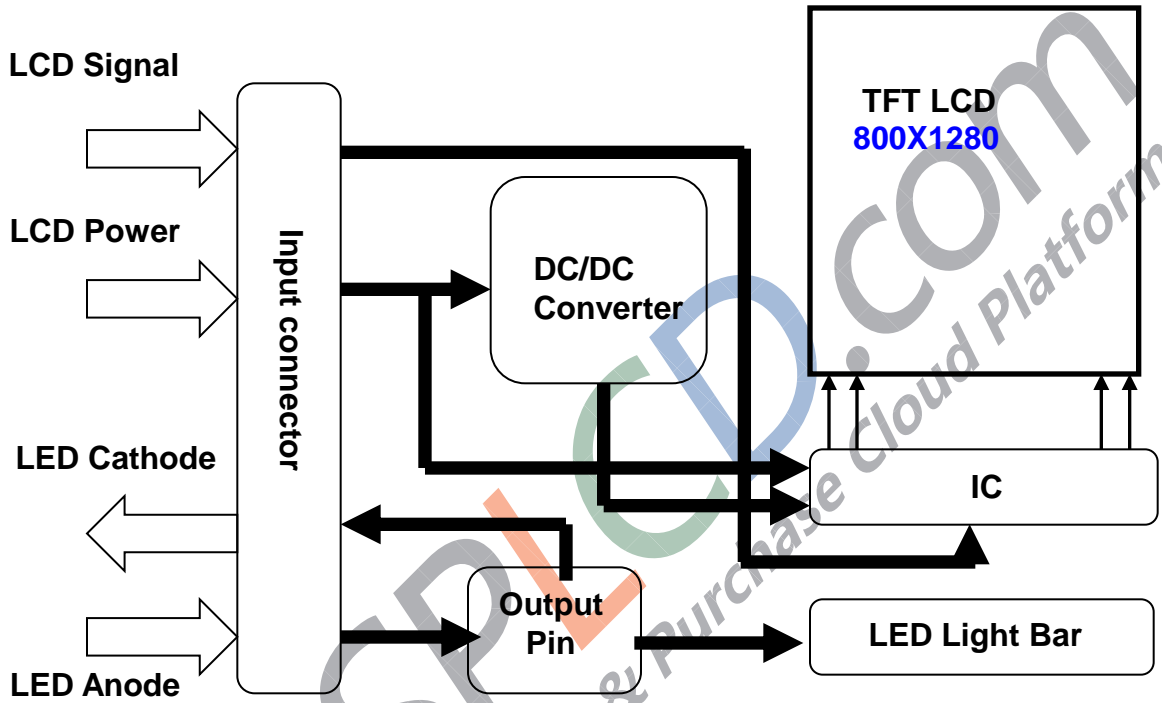

Features

TV080WXM-NL0 is 8" color TFT-LCD (Thin Film Transistor Liquid Crystal Display) module composed of LCD panel, MIPI driver IC, control circuit and backlight. By applying 8 bit digital data, 800×RGB (3) × 1280, 16.7M-color images are displayed on the 8" diagonal screen

**Product Specification**

**1-2. General Spec**

No	Item	Specification	unit	Remark
1	Screen Size	8	inch	-
2	Active Area	107.64(H) x 172.224(V)	mm	-
3	Panel Size	112.64(H)x181.24(V)	mm	-
4	Outline Dimension	114.8(H) x 184.7(V)*2.55(typ)	mm	-
5	Display Resolution	800(H) × RGB × 1280 (V)	pixel	-
6	Pixel Pitch	134.55(H) × 134.55(V)	um	-
7	Display Method	a-Si	-	-
8	Display Mode	HADS	-	-
9	Display Color	16.7M	-	8bit
10	Color Gamut	60	%	typ
11	Luminance	350(typ) 300(min)	nit	Typ, center P
12	Contrast Ratio	800:1 (typ) 600:1 (min)	-	Typ, center P
13	Viewing Angle	85/85/85/85	°	CR>10(U/D/L/R)
14	Pol Surface Treatment	AG25高精细	-	-
15	Weight	120	g	max
16	D-IC	NT35523B	-	Nova
17	Inversion Method	Z-Inversion	-	-
18	LED Q'ty	7S3P(21EA)	ea	String*Parallel
19	Power Consumption	White Patten: 1260 + 200=1460	mw	Backlight + Logic

## Product Specification

### 1-3. Key Part List(5pcs average data)

	item	Supplier	Spec/Size	Weight/ g	Remark
Cell	TFT Glass	Corning	EXG/111.64*180.274*0.5 mm		
	C/F Glass	Corning	EXG/111.64*176.974*0.5 mm		
	Upper Pol	LGC	CF: 110.04*174.62 *0.119(mm)	2.87	
	Lower Pol	LGC	TFT: 112.04*177.87 *0.114(mm)	2.78	W/O APF
	Liquid Crystal	Merck	ADS LC	0.06	
	UV Glue/Tuffy	-	-		
	D-IC	Novateck	NT35523B, 27.96*0.92*0.2mm	0.1	
	ACF(COG)	Sony	CP-36931	N/A	
	ACF(FOG)	Hitachi	AC-7813KM	N/A	
	COG Ass'y	-	-	12	
PCBA	EML coating	-	-	-	
	Main Connector	Hirose	FH26W-39S-0.3SHW(05)	1	
	FPC	元盛	58*12.5*0.23mm	1	
	FPCA	元盛	58*12.5*0.23mm	5	
	Insulation Tape	-	-	-	
	Conductive Tape	-	-	-	
	Release film on conductive tape	-	-	-	
	CNT Stiffener	-	-	-	
BLU	B/W tape	SVS	SVS-DPTB-D-60#,T=0.06	N/A	
	Top Diffuser	SKC	JS560HK,110um	3.68	
	Upper Prism	康得新	KBUO-100N, 89um	2.45	
	Lower Prism	康得新	KBCO-100S, 102um	2.87	
	Down Diffuser	东丽世韩	DL38N, 56um	1.2	
	LGP	艾宜格&嘉鸿	PC, 0.55mm	13.35	
	Mold frame	通泰	PC	1	
	Double Tape	3M	-	0.1	
	Reflector	三菱	Lumirex100	1	
	Metal Frame	州巧	SUS304 0.15mm	27.34	
	LED	隆达	Lexar,3806 ,0.6t	N/A	
	LED Lightbar	三迪	-	1	
	BLU Ass'y	CT	-		
Total	-	-	-	114	

Product Specification

1-3-1. PCBA Gerber/Layout and Schematic Diagram

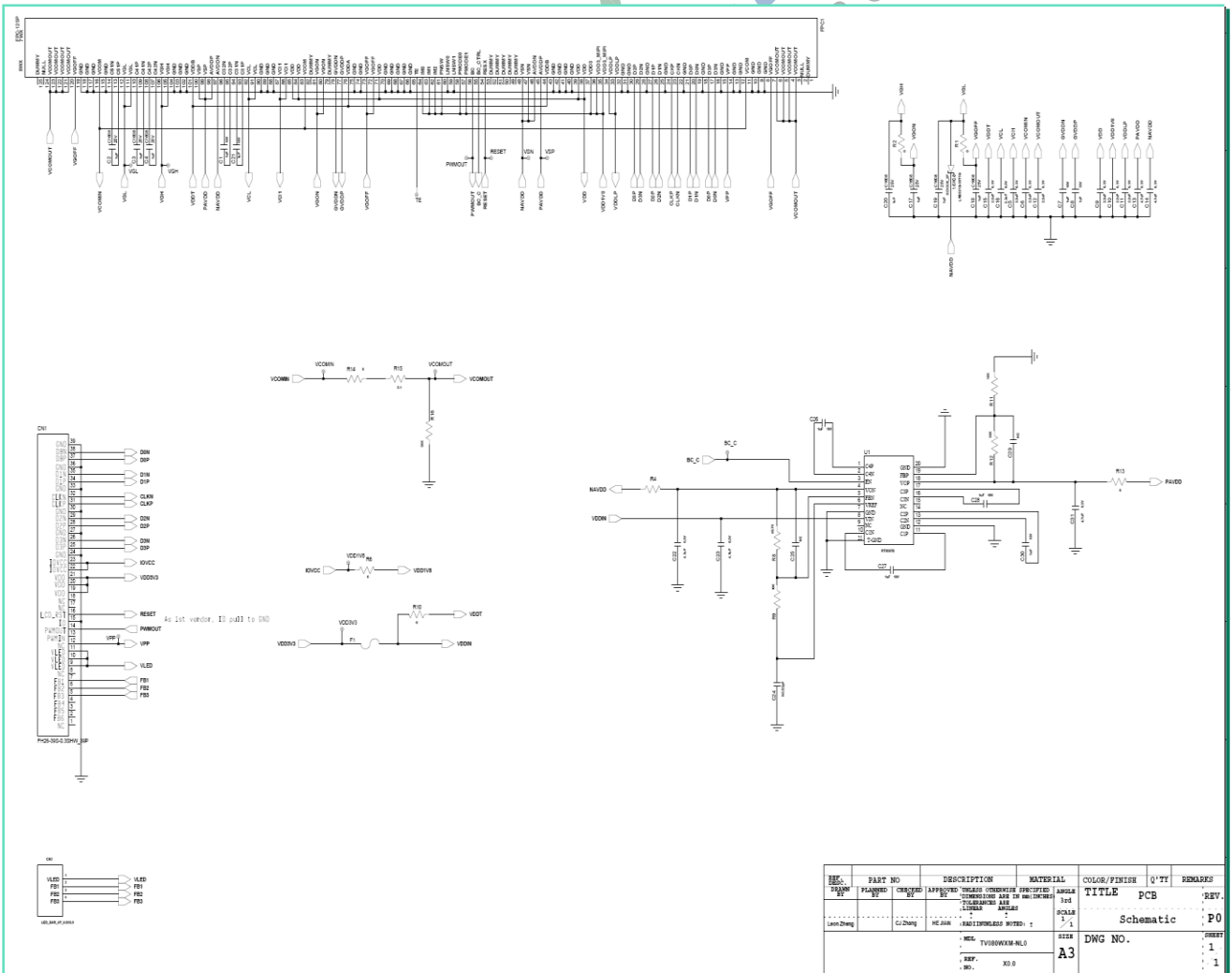
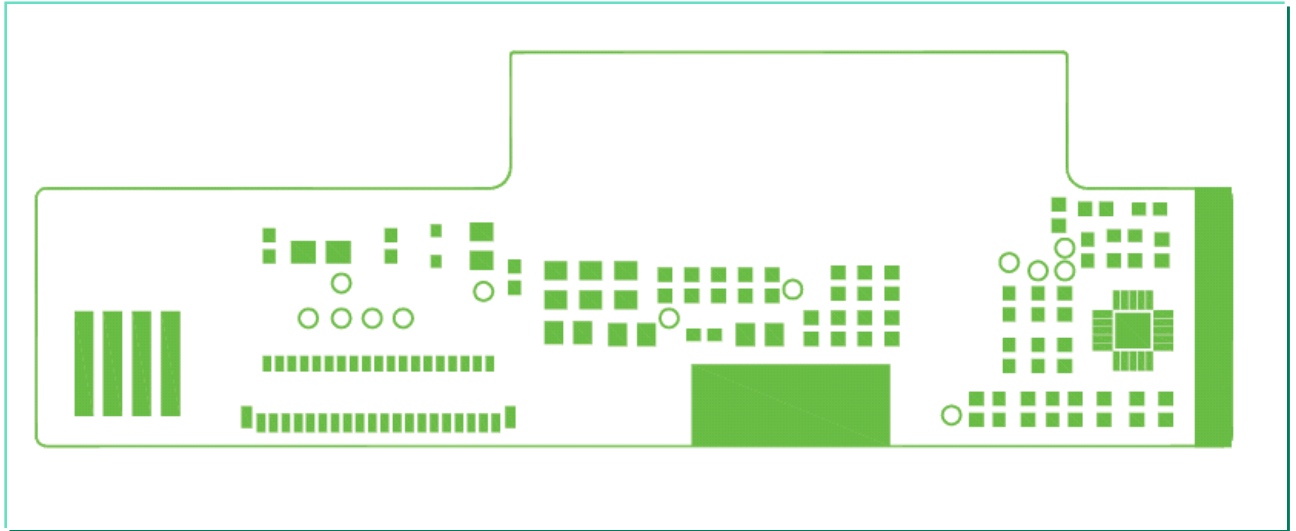

**Product Specification**

**1-3-2. FPC Pin Assignment**

Please pay attention that IC bump down(TFT glass up and C/F glass down)

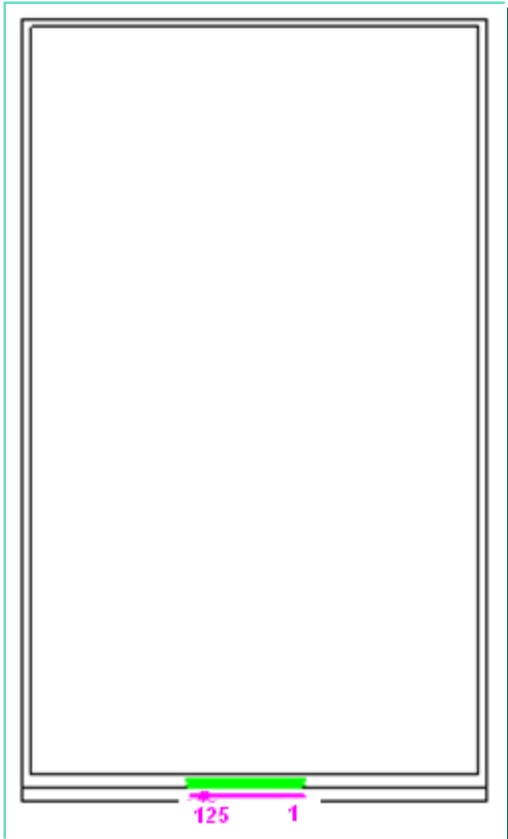

1	DUMMY	43	VDDDB	85	VCI1
2	NULL	44	AVDDP	86	VCI1
3	VCOMOUT	45	AVDDN	87	GND
4	VCOMOUT	46	VSN	88	GND
5	VCOMOUT	47	VSN	89	GND
6	VCOMOUT	48	DUMMY	90	VCL
7	VGOFF	49	DUMMY	91	VCL
8	GND	50	DUMMY	92	C31P
9	GND	51	DUMMY	93	C31N
10	GND	52	DUMMY	94	C32P
11	VCOM	53	RESX	95	C32N
12	GND	54	BC_CTRL	96	AVDDN
13	GND	55	BC	97	AVDDN
14	VPP	56	PMODE1	98	VSP
15	GND	57	PMODE0	99	VSP
16	D3N	58	LNSW1	100	VDDDB
17	D3P	59	LNSW0	101	GND
18	GND	60	PNSW	102	GND
19	D0N	61	IM2	103	GND
20	D0P	62	IM1	104	VGH
21	GND	63	IM0	105	VGH
22	CKN	64	TE	106	C42N
23	CKP	65	GND	107	C42P
24	GND	66	GND	108	C41N
25	D1N	67	GND	109	C41P
26	D1P	68	GND	110	VGL
27	GND	69	GND	111	VGL
28	D2N	70	VDD	112	C51P
29	D2P	71	VGOFF	113	C51N
30	GND	72	VGOFF	114	GND
31	GND	73	GND	115	VCOM
32	VDDLDP	74	GND	116	GND
33	VDDLDP	75	VDDA	117	GND
34	VDD3_MIPI	76	GVDDP	118	GND
35	VDD3_MIPI	77	GVDDN	119	VGOFF
36	VDD3	78	DUMMY	120	VCOMOUT
37	VDD	79	VGON	121	VCOMOUT
38	VDD	80	VGON	122	VCOMOUT
39	GND	81	DUMMY	123	VCOMOUT
40	GND	82	VCOM	124	NULL
41	GND	83	VDD	125	DUMMY
42	GND	84	VDD		



**Product Specification**

**1-3-3. Pol General Spec**

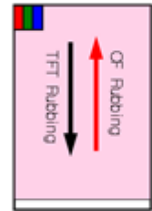
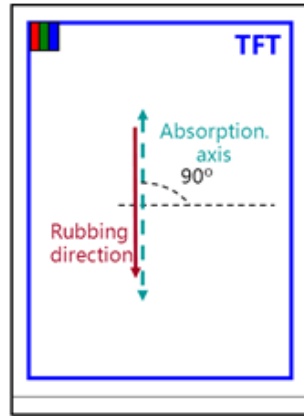
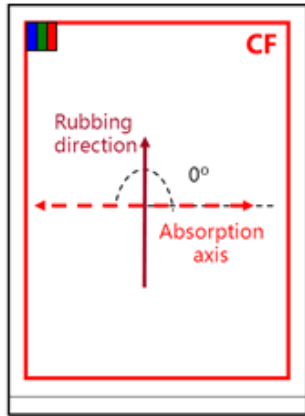
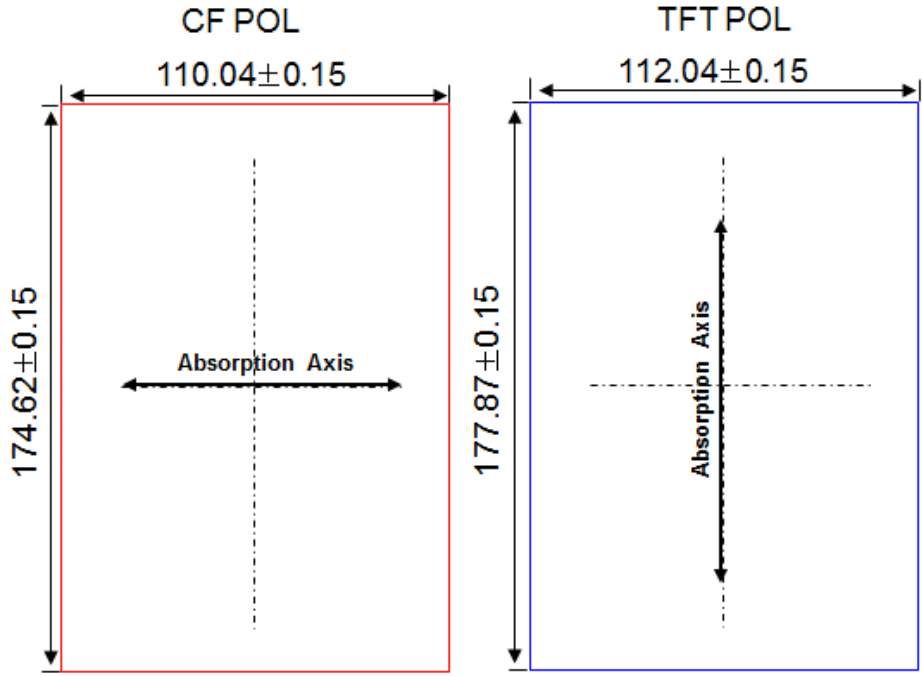

POL Spec :

Item	CF POL	TFT POL	Remark
Material	Normal TAC	Normal TAC	
Surface	AG25	Clear	
Absorption Axis(°)	0	90	O-Mode
Transmittance(%)	42.2	42.2	
Thickness(um)	119	114	

**Product Specification**

**1-4. Change List**

	No.	Reason	Change Details		Remarks
			Before	After	
H/W change	1.Change Prism Vendor	White Spot after Ball dropping	Prism (HS503+H503C)	Prism (KBUO-100N+KBCO-100S)	
Design Change	1.LGP size	Ball dropping NG	No fixed ears	Increase fixed ears	
	2.Change Cu tape size	Electrical conductivity NG	Litter contact area between Cu tape and B/C	Increase contact area between Cu tape and B/C	
S/W change					

Remarks:

- 1.H/W change includes all materials, components, label etc.
- 2.Design change includes size, position etc.
- 3.S/W change includes initial code etc.

Please pay attention that this list is just a summary, an individual Design Change List which contain much more information is also needed

**Product Specification**

**2-1. Absolute Maximum Ratings**

The following are maximum values which, if exceeded, may cause faulty operation or damage to the unit.

**Table 2.1 Absolute Maximum Ratings**

Parameter	Symbol	Values		Units	Notes
		Min	Max		
LCD Analog Voltage	VDD	-0.3	5	V	
LED Current	I <sub>LED</sub>	NA	30	mA	
Storage Humidity	Hstg	5%	90%	%RH	
Storage Temperature	Tstg	-30°C	80°C	°C	



SPLCD.COM  
Supply & Purchase Cloud Platform

**Product Specification**

**3-1. ELECTRICAL CHARACTERISTICS**

**Table 3.1 Electrical Characteristics Of TFT-LCD Module**

Parameter	Symbol	Values			Unit	Notes
		Min	Typ	Max		
LCD Input Analog Voltage	V <sub>CI</sub>	3.0	3.3	3.6	V	If necessary
LED Input Current	V <sub>DDI</sub>	1.7	1.8	1.9	V	
“H” Level Input Voltage	I <sub>LED</sub>	-	20	-	mA	
“L” Level Input Voltage	V <sub>IH</sub>	0.7xV <sub>DDI</sub>	-	V <sub>DDI</sub>	V	
“H” Level Output Voltage	V <sub>IL</sub>	0.0	-	0.3xV <sub>DDI</sub>	V	
“L” Level Output Voltage	V <sub>OH</sub>	0.8xV <sub>DDI</sub>	-	V <sub>DDI</sub>	V	
Input high level leakage current	V <sub>OL</sub>	-	-	0.2xV <sub>DDI</sub>	V	
Input low level leakage current	I <sub>IH</sub>	-	-	1	μA	
LCD Power Consumption	Logic	I <sub>IL</sub>	-1	-	μA	
	Sleep Mode	P <sub>N</sub>	0.2 (W pattern)	0.23(W pattern) 0.35(R/G/B pattern)	W	1
	BLU	P <sub>N</sub>	-	1.26	1.386	W

**Notes:**

(1) The specified current and power consumption are under the conditions at V<sub>DD</sub> = 3.3V, T = 25°C, and f<sub>v</sub> = 60 Hz, at white pattern (TYP)

The specified current and power consumption are under the conditions at V<sub>DD</sub> = 3.3V, T = 25°C, and f<sub>v</sub> = 60 Hz, at R/G/B pattern (MAX)

(2) LED Backlight assumptions: 21 Vf(MAX), 60 mA. (7S3P LED Total Input )

**3-2. Logic Power Consumption**

Parameter	Symbol	Values		Units	Notes
		Typ	Max		
Normal Mode	I <sub>VDD</sub>	60	70	mA	White Pattern
Sleep Mode	I <sub>VDD</sub>	-	-	uA	White Pattern

**Product Specification**

**3-3. BACK LIGHT UNIT**

**3-3-1 The edge-lighting type of back light unit consists of 21 LEDs which is connected in serial.**

Table 2-3-1 Electrical Characteristics Of Back Light Unit

Parameter	Symbol	Values			Units	Notes
		Min	Typ.	Max		
LED Current	$I_{LED}$	-	20	-	mA	7S3P
LED Forward Voltage	$V_{LED}$	-	3.0	3.3	V	7S3P

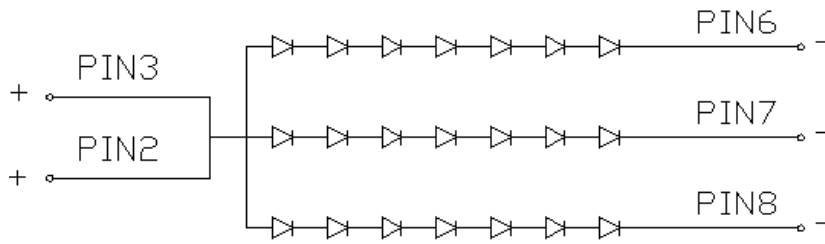

LED Circuit Diagram

**3-3-2 LED Rank**

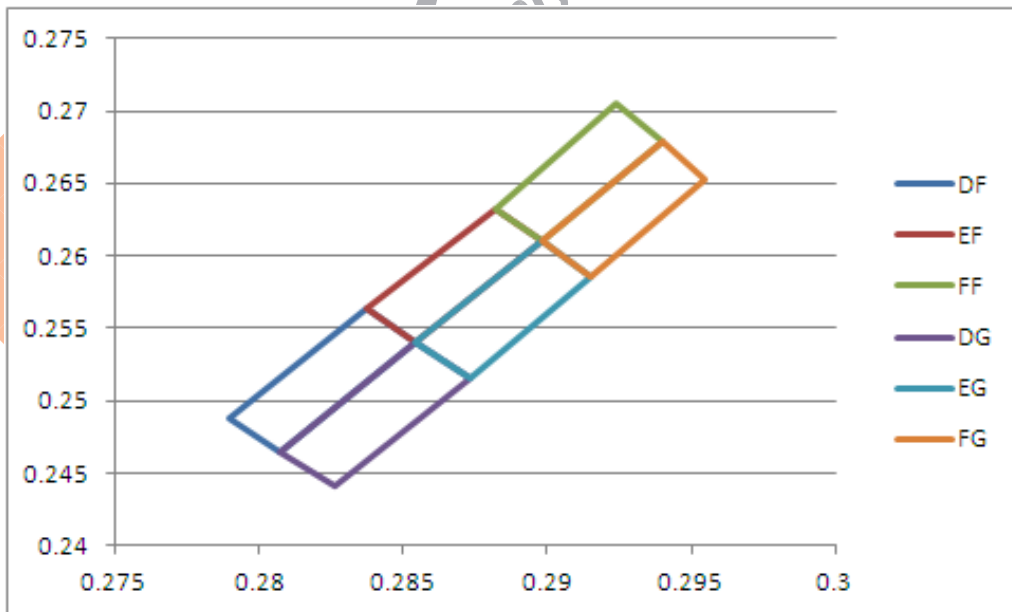

**Product Specification**

**3-4. LCD INTERFACE CONNECTIONS**

Interface Connector: FH26W-39S-0.3SHW(Hirose)

**Table 3.4 LCD Connector Pin Configuration**

Pin No.	Symbol	I/O	Description
1	NC	-	NC
2	NC	-	NC
3	NC	-	NC
4	NC	-	NC
5	FB3	P	LED-
6	FB2	P	LED-
7	FB1	P	LED-
8	NC	-	NC
9	VLED	P	LED+
10	VLED	P	LED+
11	VLED	P	LED+
12	NC	-	7.5V For VPP
13	LED PWMIn	I	NC
14	LED PWMOut	O	LED PWMOut
15	ID	I/O	ID(GND for BOE)
16	LCD_RST	I	Reset
17	NC	-	NC
18	NC	-	NC
19	VDD	P	3.3V
20	VDD	P	3.3V
21	VDD	P	3.3V
22	IOVCC	P	1.8V
23	IOVCC	P	1.8V
24	GND	P	GND
25	D3P	I	MIPI Input Data Pair D3P
26	D3N	I	MIPI Input Data Pair D3N
27	GND	P	GND
28	D2P	I	MIPI Input Data Pair D2P
29	D2N	I	MIPI Input Data Pair D2N
30	GND	P	GND
31	CLKP	I	MIPI Input Data Pair CLKP
32	CLKN	I	MIPI Input Data Pair CLKN
33	GND	P	GND
34	D1P	I	MIPI Input Clock Pair D1P
35	D1N	I	MIPI Input Clock Pair D1N
36	GND	P	GND
37	D0P	I	MIPI Input Data Pair D0P
38	D0N	I	MIPI Input Data Pair D0N
39	GND	I	GND

P:Power or GND, I:Input, O:Output

Product Specification

3-5. SIGNAL TIMING SPECIFICATIONS

ITEM		SYMBOL	min	typ	max	UNIT	
LCD	Frame Rate	-	-	60	-	Hz	
	Pixels Rate	-	-	68.4	-	MHz	
Timing	DCLK	Frequency	fCLK	-	450	MHz	
		Period	Tclk	-	2.22	ns	
	Horizontal	Horizontal total time	tHP	-	880	-	t <sub>CLK</sub>
		Horizontal Active time	tHadr	800		-	t <sub>CLK</sub>
		Horizontal Pulse Width	tHsync	-	16	-	t <sub>CLK</sub>
		Horizontal Back Porch	tHBP	-	48	-	t <sub>CLK</sub>
		Horizontal Front Porch	tHFP	-	16	-	t <sub>CLK</sub>
	Vertical	Vertical total time	tvP	-	1296	-	t <sub>H</sub>
		Vertical Active time	tVadr	1280		-	t <sub>H</sub>
		Vertical Pulse Width	tVsync	-	4	-	t <sub>H</sub>
		Vertical Back Porch	tVBP	-	4	-	t <sub>H</sub>
		Vertical Front Porch	tVFP	-	8	-	t <sub>H</sub>
	Differential Swing		VDswing	-	400	-	mV
	Bit Rate		TX SPD(MBPS)	-	450	-	Mbps
Pixel Fomat		-	-	24	-	Data bit/pixel	
Lane		-	-	4	-	Lane	

※Please refer to initial code

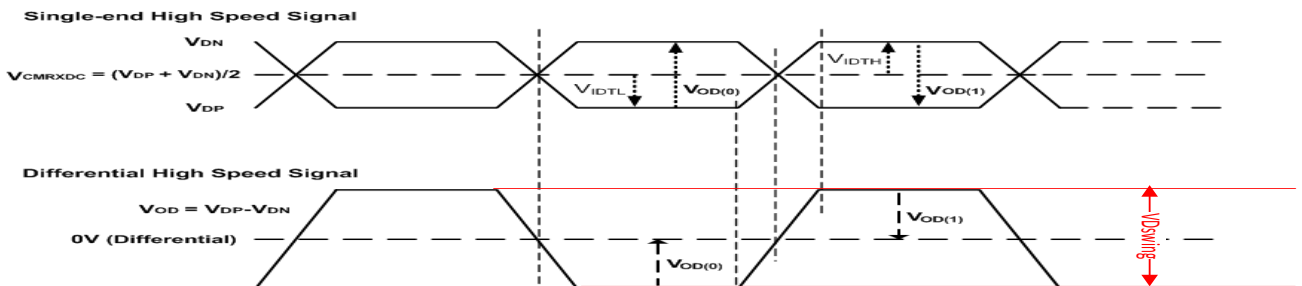
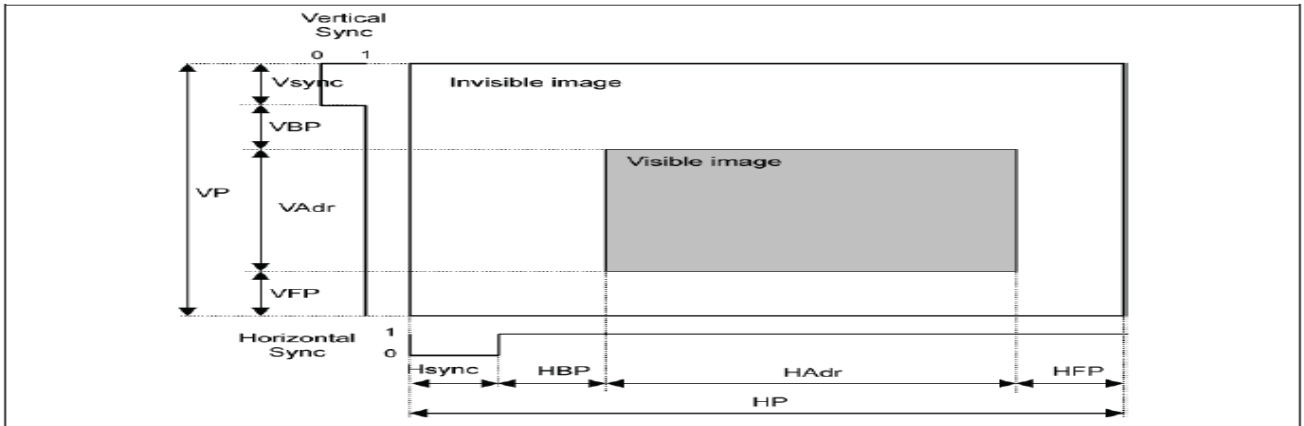

**Product Specification**

**3-6. MIPI Data&CLK Line Impedance Test Result**

**(1) MIPI Interface Timing Sequence**

**(a) MIPI interface DC characteristic :**

Parameter	Symbol	Min	Typ	Max	Unit	Condition
MIPI digital operation current	$I_{VCCIF}$	-	7	-	mA	-
MIPI digital stand-by current	$I_{VCCIFST}$	-	300	-	uA	-
<b>MIPI Characteristics for High Speed Receiver</b>						
Single-ended input low voltage	$V_{ILHS}$	-40	-	-	mV	
Single-ended input high voltage	$V_{IHHS}$	-	-	460	mV	
Common-mode voltage	$V_{CMRXDC}$	70	-	330	mV	
Differential input impedance	$Z_{ID}$	80	100	125	$\Omega$	
HS transmit differential voltage( $V_{OD}=V_{DP}-V_{DN}$ )	$ V_{OD} $	140	200	250	mV	
<b>MIPI Characteristics for Low Power Receiver</b>						
Pad signal voltage range	$V_I$	0	-	1350	mV	
Ground shift	$V_{GND SH}$	-50	-	50	mV	
Output low level	$V_{OL}$	-50	-	50	mV	
Output high level	$V_{OH}$	1.1	-	1.3	V	

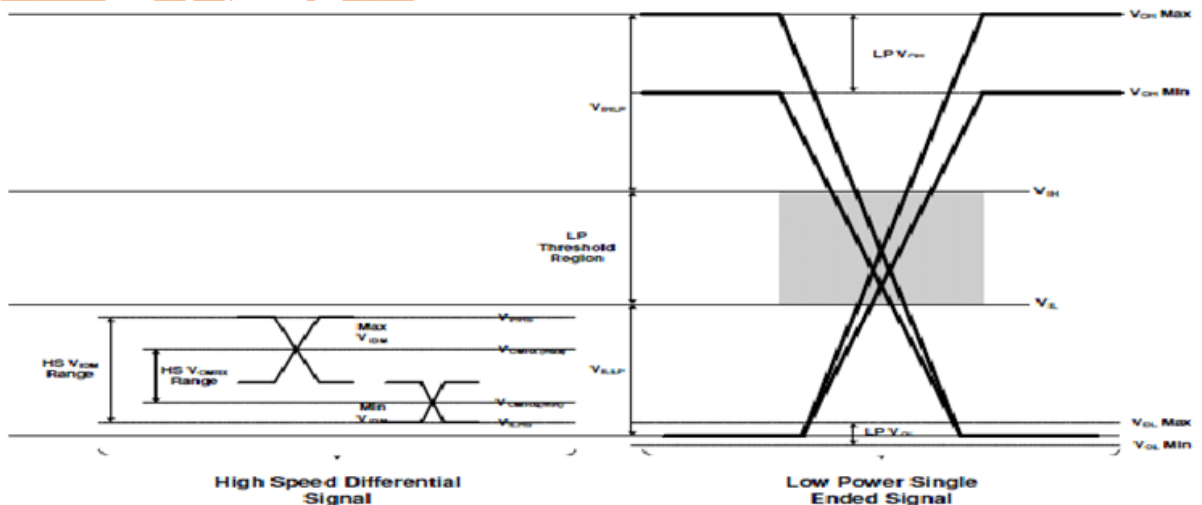

**MIPI DC Diagram**



**Product Specification**

**(b) MIPI data to clock timing definitions**

Clock Parameter	Symbol	Min	Typ.	Max.	Unit
UI instantaneous	UI INST	2	—	4	ns
Data to Clock Setup Time [Receiver]	T SETUP[RX]	0.15	—	—	UI INST
Clock to Data Hold Time [Receiver]	T HOLD[RX]	0.15	—	—	UI INST

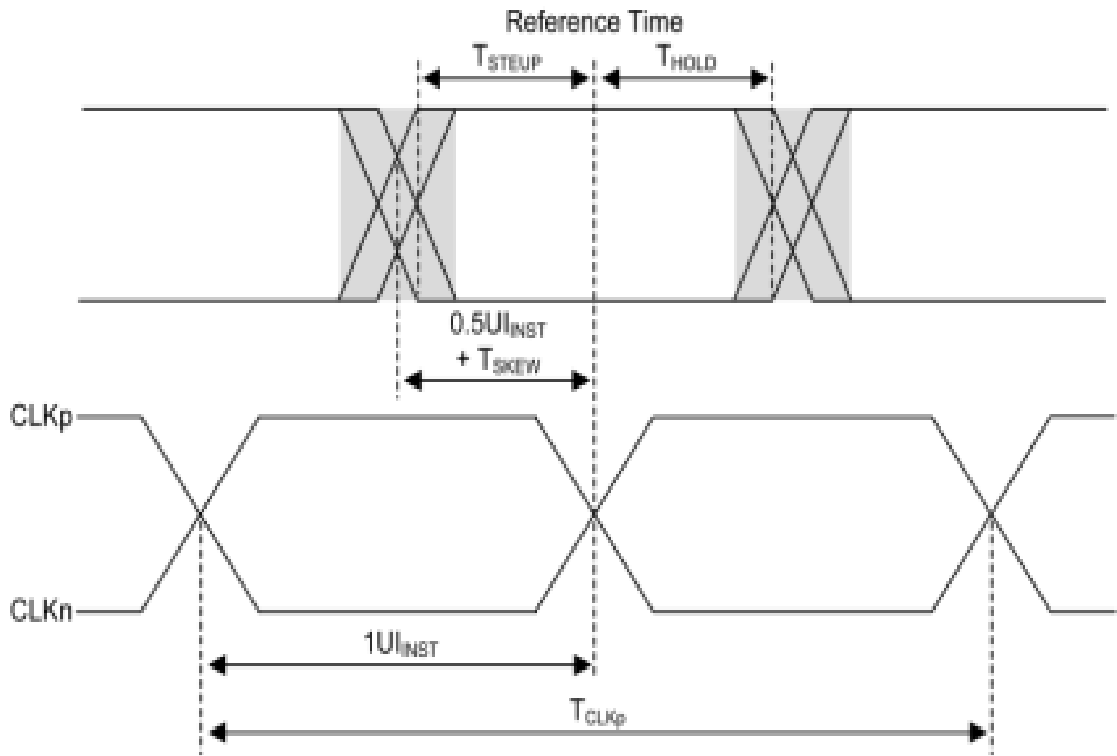

MIPI data to clock timing definitions

**Product Specification**

**3-7. Power On/Off Sequence**

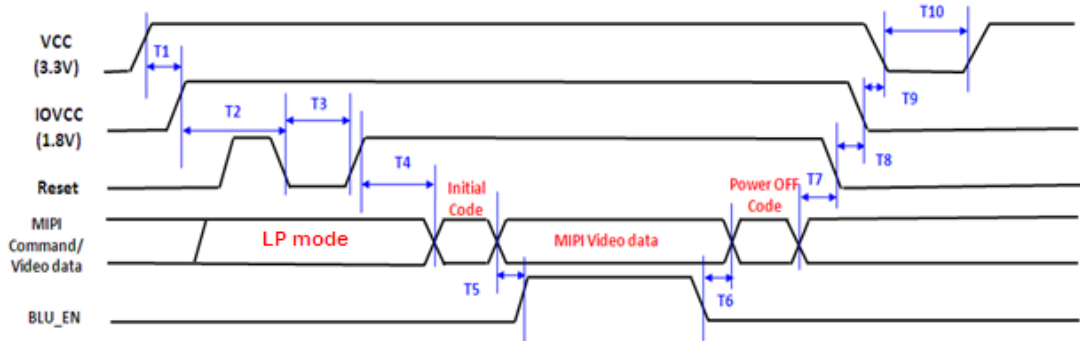

POWER ON/OFF Timing			
parameters	Value		Unit
	Min.	Max.	
T1	0.5	10	ms
T2	15	100	
T3	0.02	0.5	
T4	20	200	
T5	200	500	
T6	40	200	
T7	100	200	
T8	1	100	
T9	No Limit	No Limit	
T10	500	No Limit	



**Product Specification****3-8. IC General Spec and Size****General Description**

The NT35523B device is a single-chip solution for a-Si TFT LCD that incorporates gate drivers and is capable of

800RGBx1280, 768RGBx1280, 720RGBx1280, 640RGBx1024, 600RGBx1024 and 540RGB x 960 without

internal CGRAM. It includes a timing controller with glass interface level-shifters and a glass power supply circuit.

The NT35523B supports MIPI Interface only.

The NT35523B is also able to make gamma correction settings separately for RGB dots to allow benign

adjustments to panel characteristics, resulting in higher display qualities.

This LSI is suitable for small or medium-sized portable mobile solutions requiring long-term driving capabilities,

including bi-directional pagers, digital audio players, cellular phones and handheld PDA.

**FEATURES**

VGHO/VGLO voltage generator for gate control signal and panel

Oscillator for display clock

Supports gate control signals to gate driver in the panel

Content Adaptive Brightness Control (CABC)

Image Enhancement (IE): include brightness/edge/vivid color enhancement

Sunlight Readability Enhancement (SRE)



**Product Specification**

**3-9. Power Consumption**

	Parameter	Symbol	Typ	Unit	Remarks	
CABC off	Logic Power	L0	153	mW		
		L32	165	mW		
		L64	165	mW		
		L96	168.3	mW		
		L127	168.3	mW		
		L160	168.3	mW		
		L192	168.3	mW		
		L224	171.6	mW		
		L255	171.6	mW		
		R255	297	mW		
		G255	297	mW		
		B255	297	mW		
		8 color bar	280.5	mW		
		0-255 Gray Transition	280.5	mW		
		Lenovo UI	-	mW	Lenovo will send pic.	
	Icon Interface	-	mW			
	BLU		25% on	0.315	W	
			50% on	0.63	W	
75% on			0.945	W		
100% on			1.26	W		



**Product Specification**

**4. OPTICAL CHARACTERISTICS**

**4-1. Optical Characteristics – Backlight 100%**

Parameter	Symbol	Condition	Min	Typ	Max	Unit	Remarks
Viewing Angle	Θ12	CR >10	80	85	-	°	Note 1
	Θ6		80	85	-	°	Note 1
	Θ9		80	85	-	°	Note 1
	Θ3		80	85	-	°	Note 1
	Θ1	CR>10	80	85	-	°	Note 1
	Θ4		80	85	-	°	Note 1
	Θ7		80	85	-	°	Note 1
	Θ11		80	85	-	°	Note 1
Contrast Ratio	CR	Optimal	600	800	-	-	Note 1,4
Brightness	Lv	Optimal	300	350	-	cd/m <sup>2</sup>	Note 1
Brightness Uniformity	Y	Optimal	80	85	-	%	Note 1,7(9P)
Flicker				-30		dB	Note 1,2
Crosstalk					2	%	Note 1,3
Response time	T <sub>f</sub> or T <sub>r</sub>	Θ = 0 ° Ta =25 °C	-	25	35	ms	Note 1,6
Color Gamut	NTSC	-	55	60	-	%	Note 1
White Chromaticity	x	CIE 1931	0.27	0.30	0.33	-	Note 1
	y		0.29	0.32	0.35	-	Note 1
Red Chromaticity	x	CIE 1931	0.586	0.616	0.646	-	Note 1
	y		0.326	0.356	0.386	-	Note 1
Green Chromaticity	x	CIE 1931	0.301	0.331	0.361	-	Note 1
	y		0.569	0.599	0.629	-	Note 1
Blue Chromaticity	x	CIE 1931	0.125	0.155	0.185	-	Note 1
	y		0.058	0.088	0.118	-	Note 1

**4-2. Cell&BLU Optical Characteristics**

Parameter	Typ	Unit	Remarks
Aperture Ratio	64%	%	
Upper Pol Trans.	42.5	%	
Lower Pol Trans.	41.4	%	
Panel Trans.	4.6%	%	w/o APF
Panel Trans.	-	%	with APF
BLU Luminance	7600	Cd/m <sup>2</sup>	Center
BLU Luminance Uniformity	85%typ;80%min	%	9PIONT

Product Specification

4-3. Gamma/Color Coordinate Uniformity/CE Function/CABC Function (TBD)

4.3-1 Gamma Curve

Request: R/G/B/W, 0-255 gray scale, step 1 gray scale

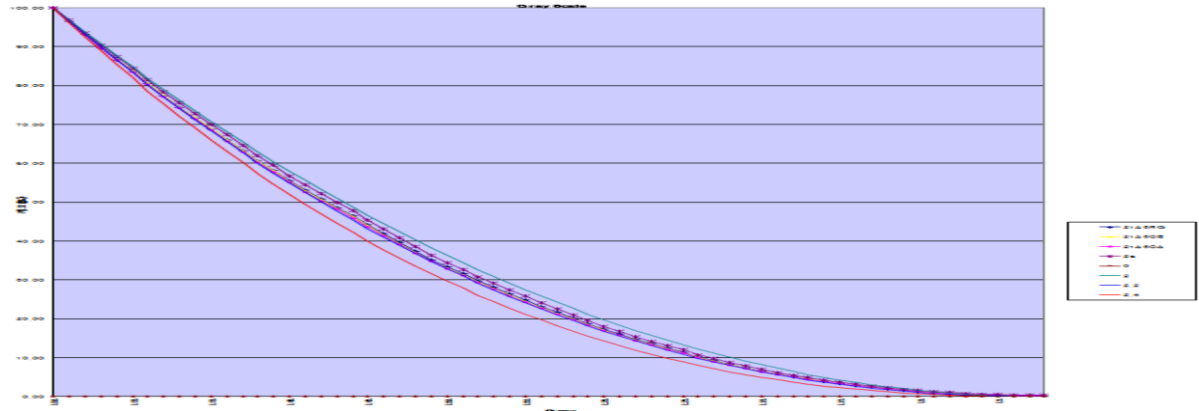

4.3-2 Color Coordinate Uniformity

Request: white pattern, 0-255 gray scale, step 15 gray scale.

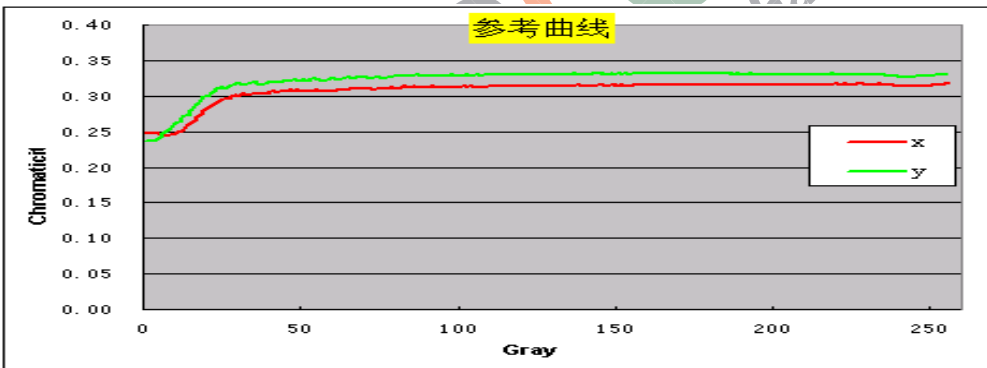

4.3-3 CE function(on and off)

Request: Macbeth color checker. Please provide all CE on data if there is more than one CE solution. Need color coordinate of Macbeth color checker, while CE on and CE off

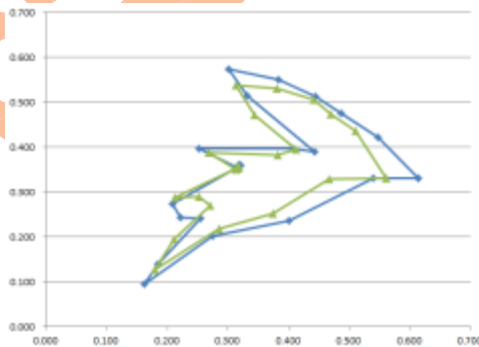

暗的.b



亮+暗.b



亮的.b

4.3-4 CABC function(on and off)

Request: Movies comparison( three segments with different frames details, lighter, light+dark, darker) Measure LCD power consumption of three segments , including logic and BLU

**Product Specification**

**4-4. LCD Spectrum and BLU Spectrum**  
Center Point

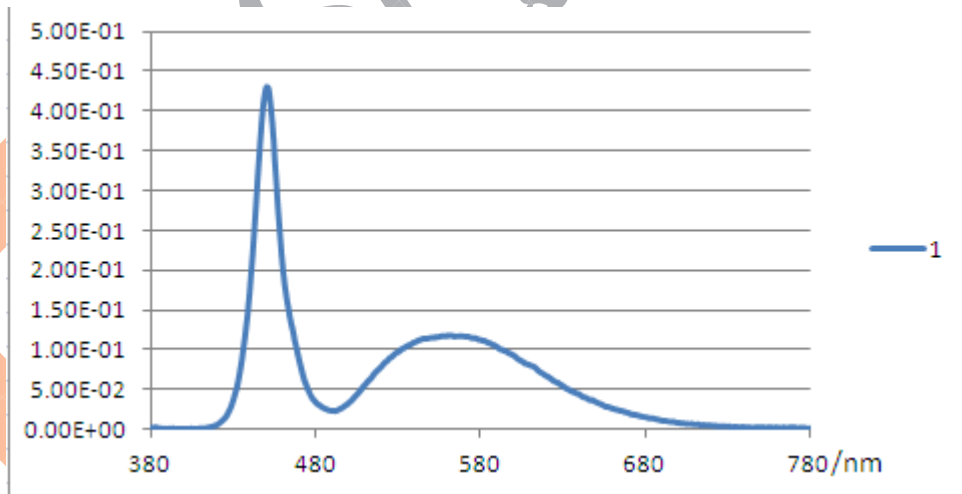
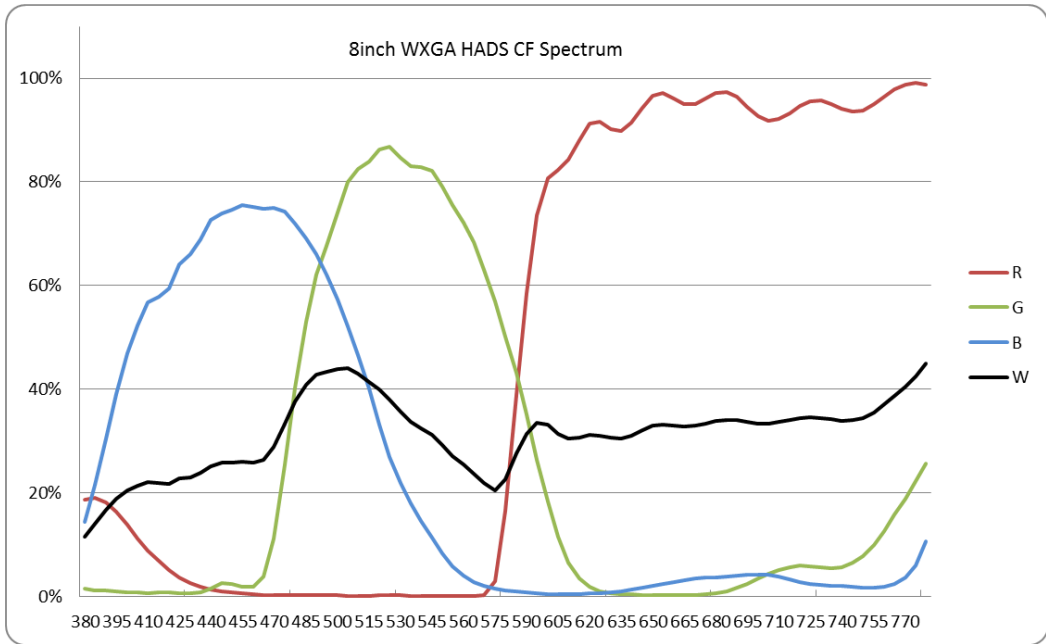

**Product Specification**

[Note 1] Optical Test Equipment Setup

The LCD module should be turn-on to a stable luminance level to be reached. The measurement should be executed after lighting Backlight for 20 minutes and in a dark room.

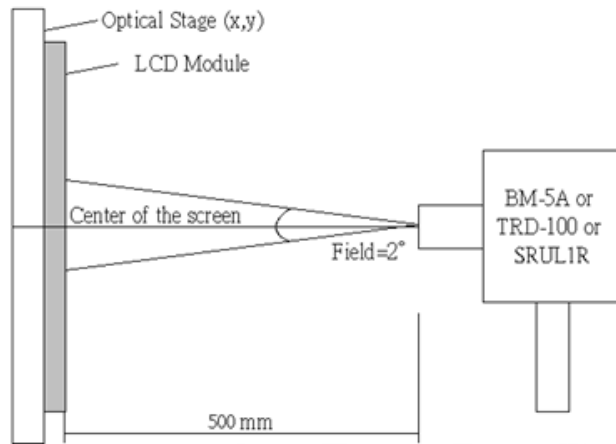

**Fig 4.1. Optical Characteristic Measurement Equipment and Method**

[Note 2] Flicker

The flicker level should be measured with horizontal gray/black stripes. The flicker is essentially a ratio of the powers in the frequency spectrum at 30 Hz ( $P_x$ ) and 0 Hz ( $P_0$ , DC level).

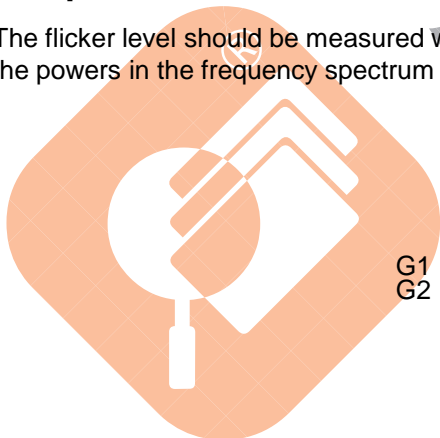

$$F = 20 \text{ Log } (P_x / P_0)$$

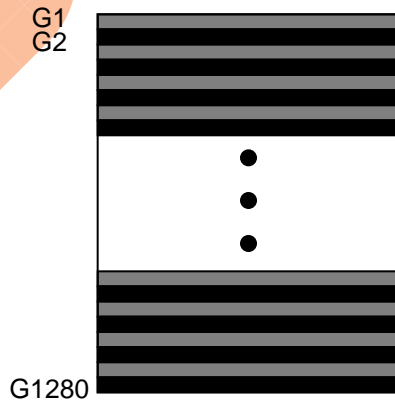



Product Specification

[Note 3] Crosstalk

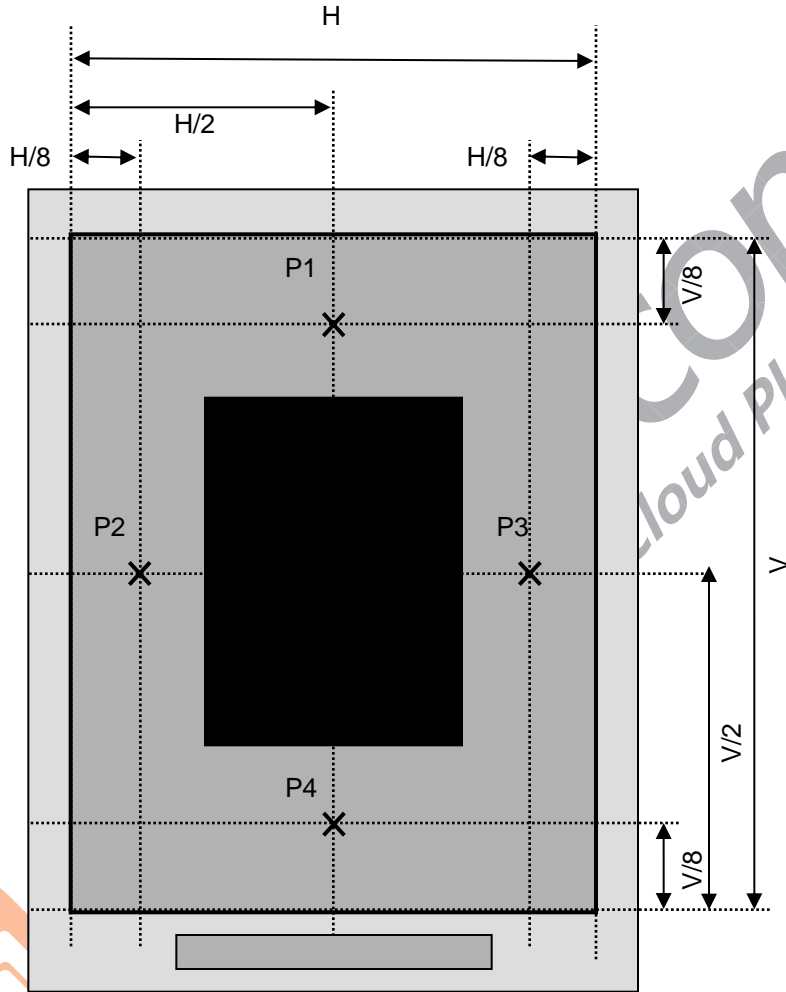

Fig 2-5. Crosstalk measurement points

A: Luminance for P1 ~ P4 with all 127gray pixels

B: Luminance for P1 ~ P4 with 127gray pixels when the black box is applied

$$\text{Crosstalk [\%]} = \text{Maximum} \left[ \text{Absolute} \left( \frac{A - B}{A} \right) \right]$$

**Product Specification**

[Note 4]

Contrast Ratio is defined as follows ;

$$\text{Contrast Ratio(CR)} = \frac{\text{Photo detector output with LCD being "White"}}{\text{Photo detector output with LCD being "Black"}}$$

[Note 5]

Viewing Angle Range is defined as follows;

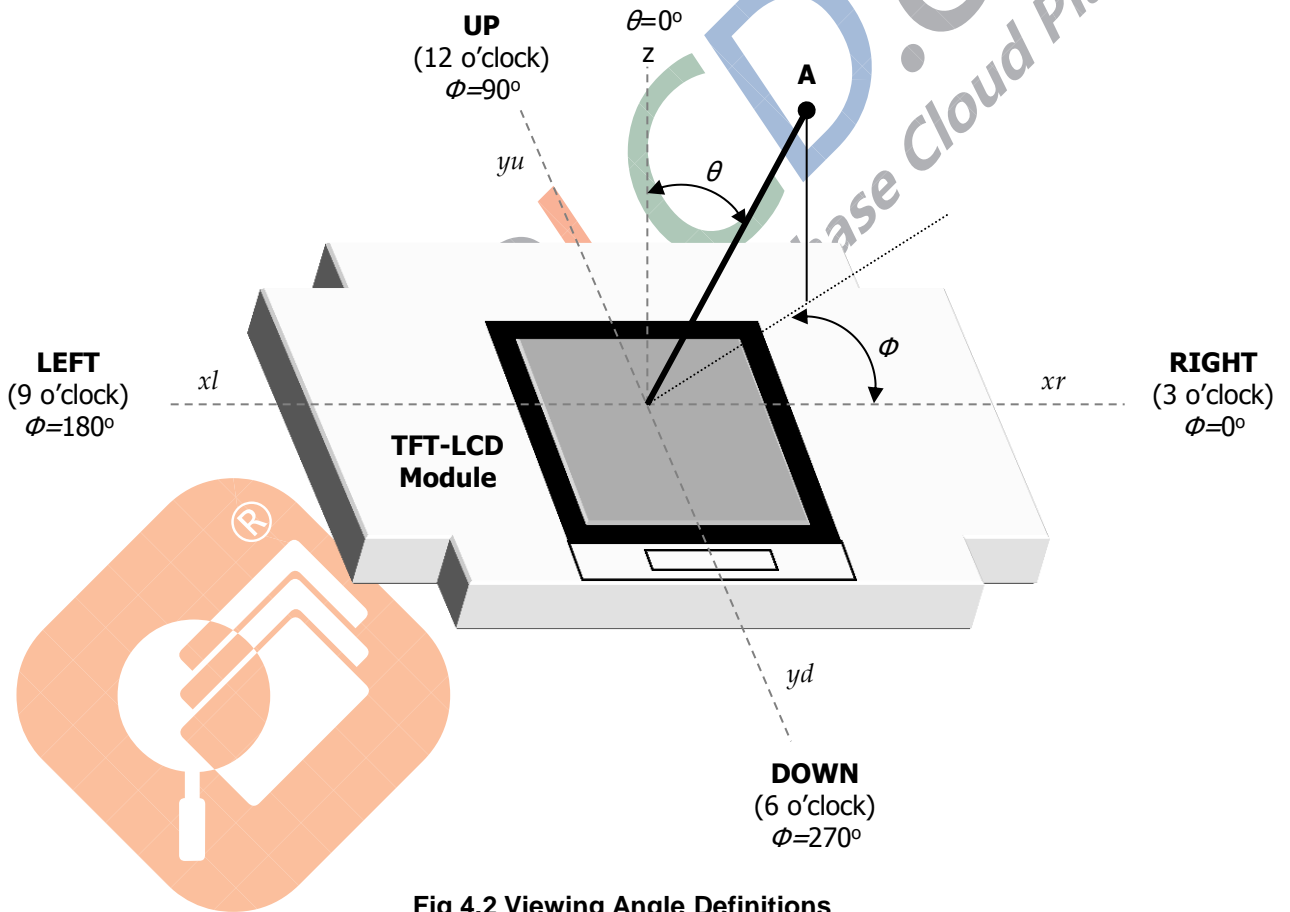
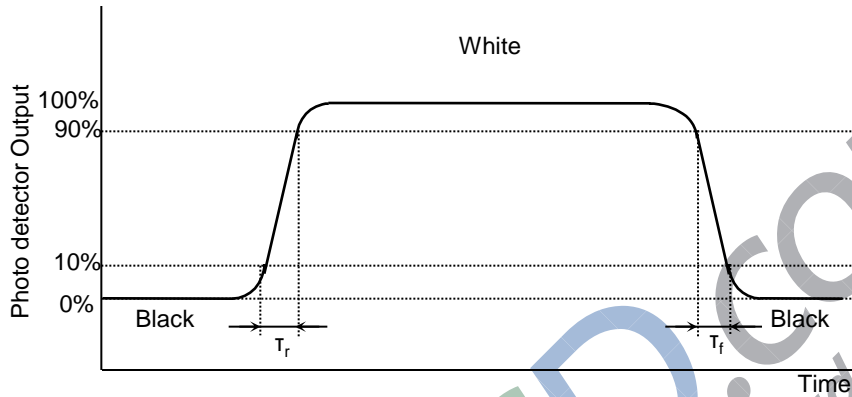

**Fig 4.2 Viewing Angle Definitions**

**Product Specification**

[Note 6]

Response time is obtained by measuring the transition time of photo detector output, when input signals are applied so as to make the area “black” to and from “white”.



[Note 7]

**Fig 4.3 Response Time Definition**

The brightness measurement is taken at point 9P.

$$\text{Brightness Uniformity} = \frac{\text{Minimum Photo detector output for P1-P9 with all pixels white}}{\text{Maximum Photo detector output for P1-P9 with all pixels white}} \times 100$$

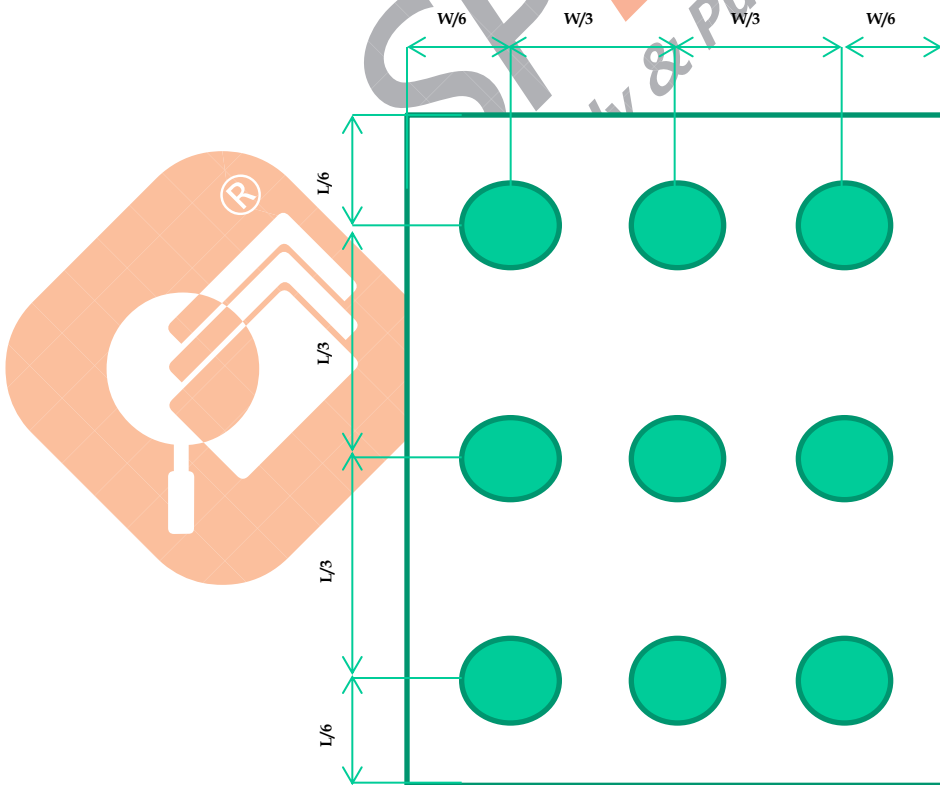

**Fig 4.4 Brightness Measurement Points**

**Product Specification**

**5. MECHANICAL CHARACTERISTICS**

The contents provide general mechanical characteristics for the model.  
In addition the figures in the next page are detailed mechanical drawing of the LCD.

Items	Description	Typ.	Tolerance	Unit
Mother Glass	Size	2500*2200	-	mm
Q-Panel	Size	710.64×371.648 mm	-	mm
C/F and TFT thickness after slimming	thickness	0.5/ 0.5	±0.02	mm
Panel	A/A	107.64*172.224	-	mm
	C/F	111.64*176.974	±0.2	mm
	TFT	111.64*180.274	±0.2	mm
	BM(U/D/L/R)	2.4/4.05 /2.5/2.5	-	mm
	IC Bonding Area	3.3	-	mm
	Pol Size	CF: 110.04*174.62	-	mm
	Gap Between Pol-C/F border (U/D/L/R)	CF: 1.2/2.854/1.3/1.3	±0.3	mm
Module	Horizontal	114.8	±0.3	mm
	Vertical	184.7	±0.3	mm
	Thickness	2.55	±0.15	mm
	UV Glue Thickness	<0.10	-	mm
	Gap between Glass~L CM outline	1.18/1.08/1.08/1.696	±0.3	mm

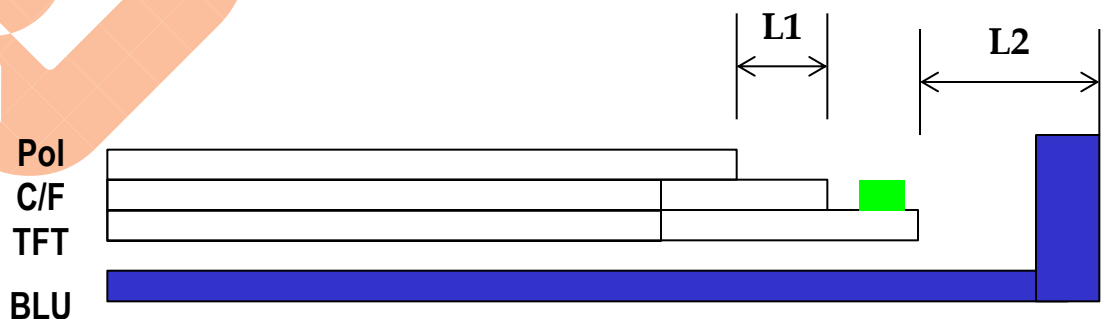
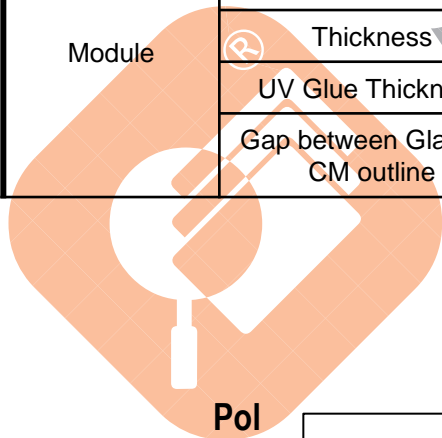

**Product Specification**

**5.1 LCM Drawing**

Folded and unfolded status

(1) Front side

The tolerance, not show in the figure, is  $\pm 0.2\text{mm}$ .

[Unit : mm]

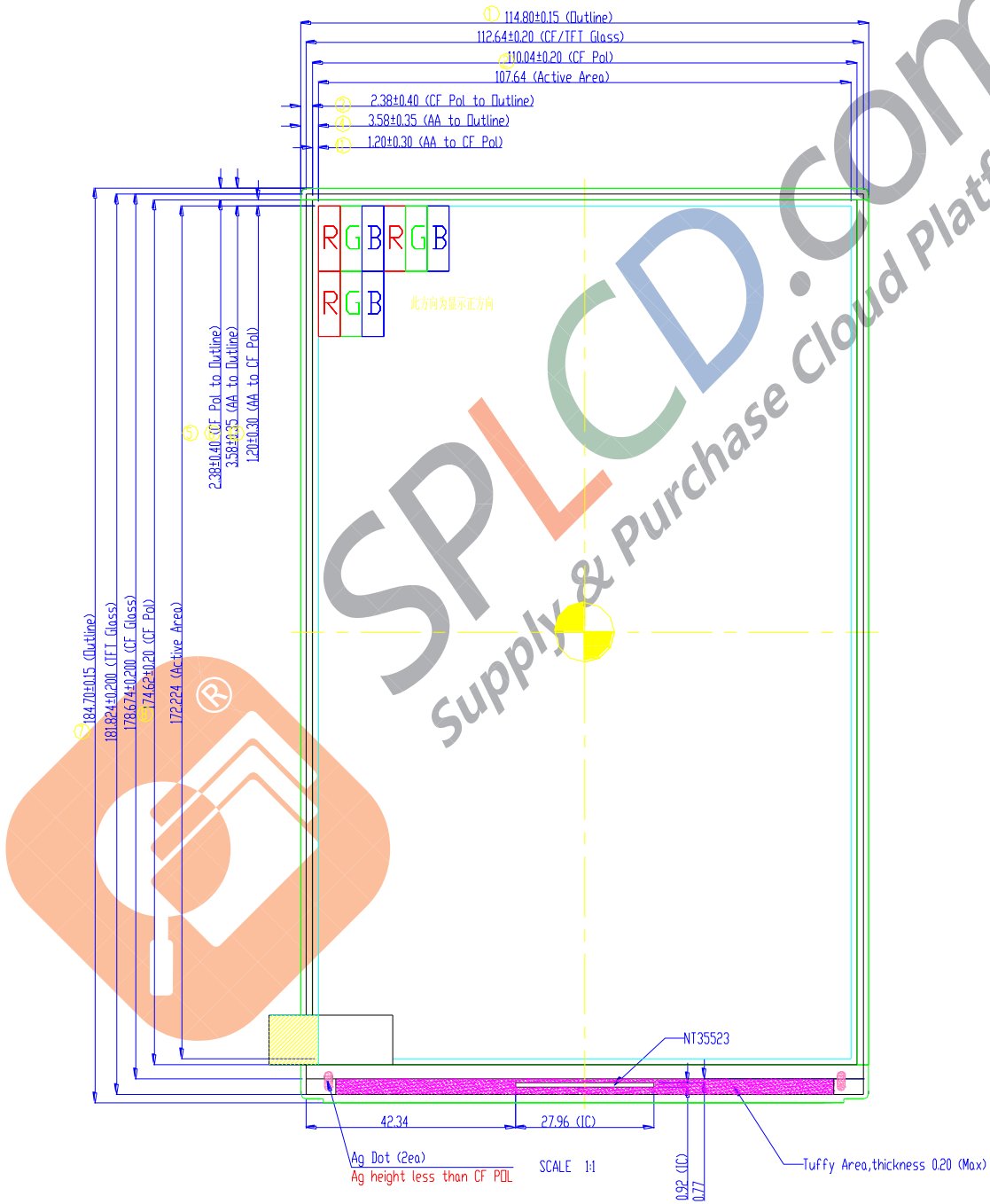

**Product Specification**

(1) Rear side

The tolerance, not show in the figure, is  $\pm 0.2\text{mm}$ .

[Unit : mm]

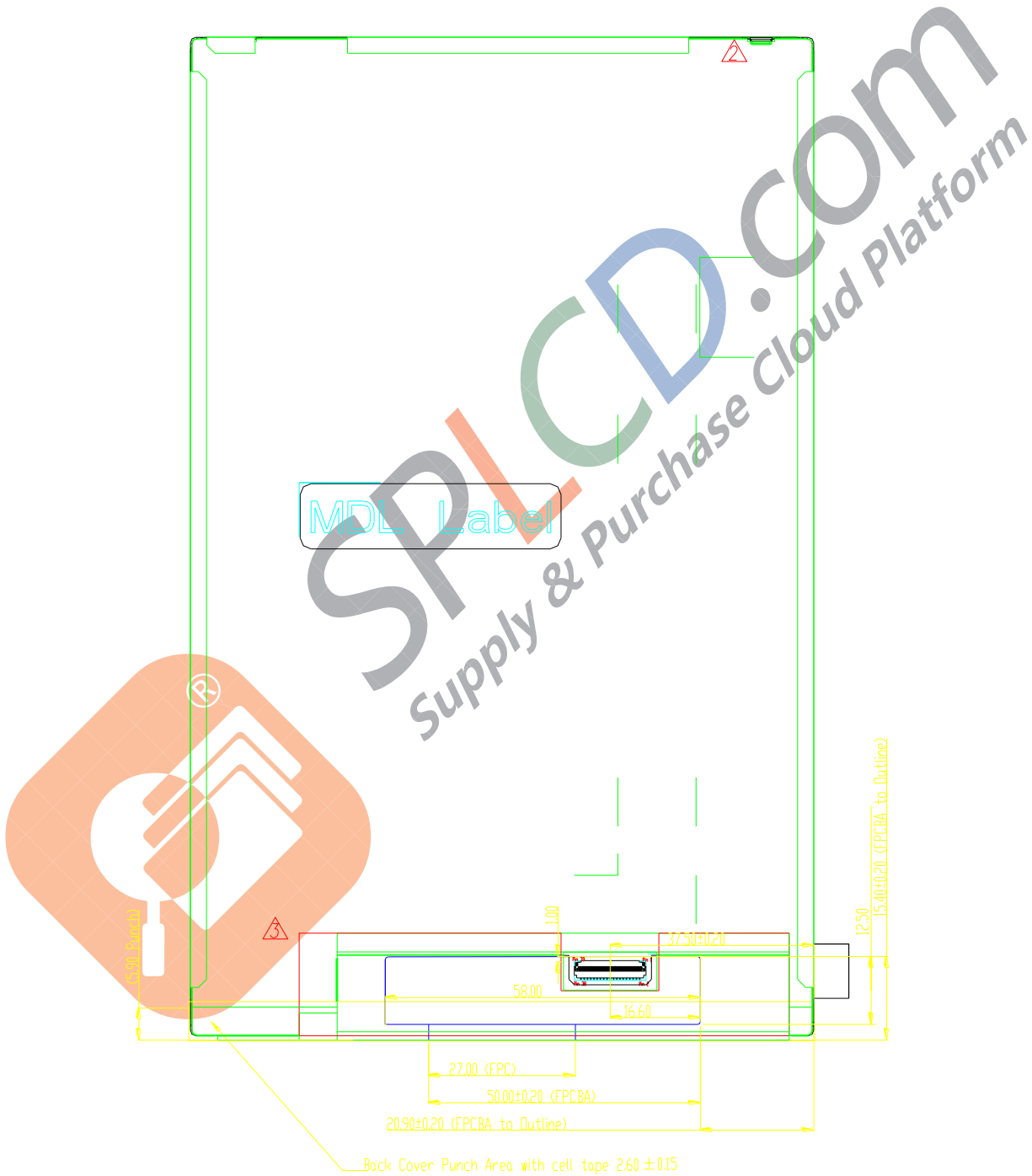

Product Specification

5.2-1 BLU Outline Dimension Including each film

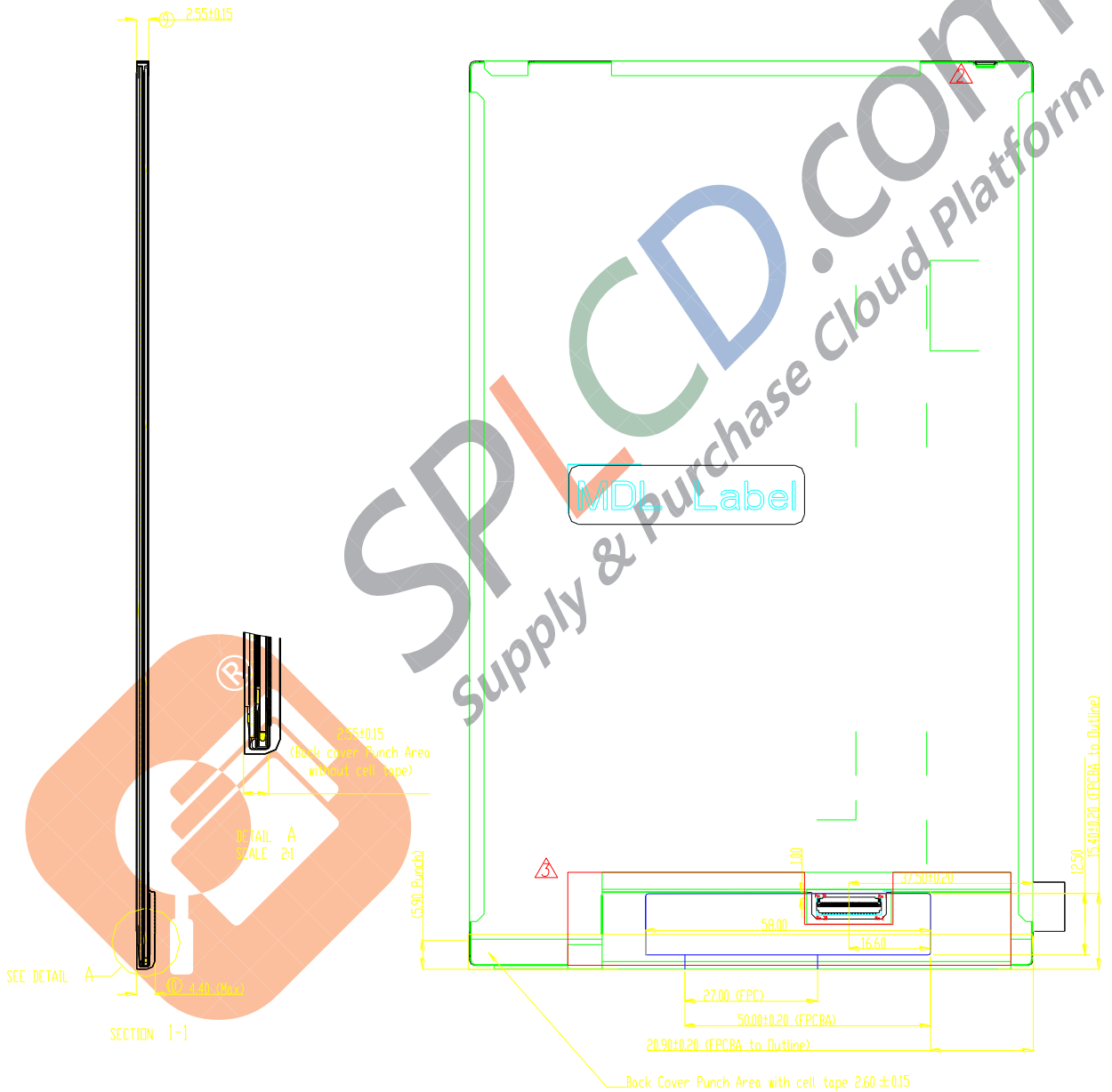

Product Specification

5.2-2 BLU Section Review

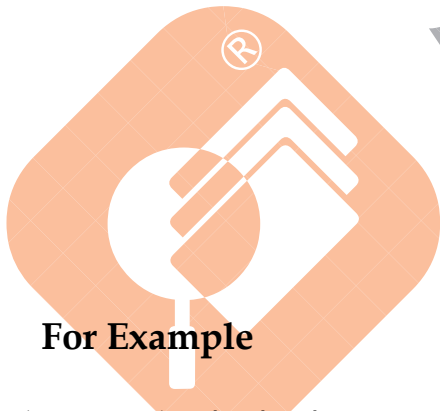
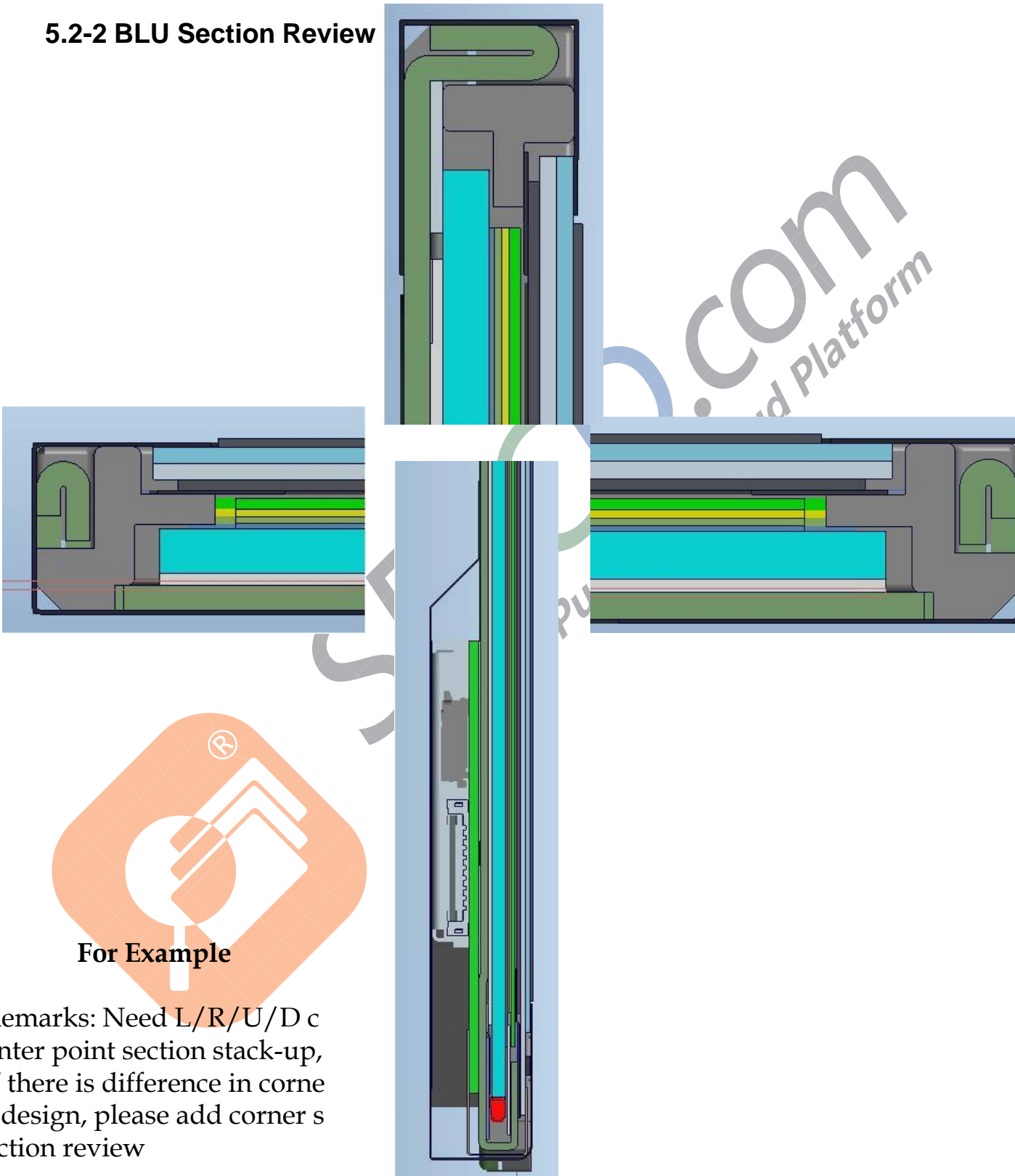

**For Example**

Remarks: Need L/R/U/D center point section stack-up, if there is difference in corner design, please add corner section review



Product Specification

5.3 Panel Outline Dimension

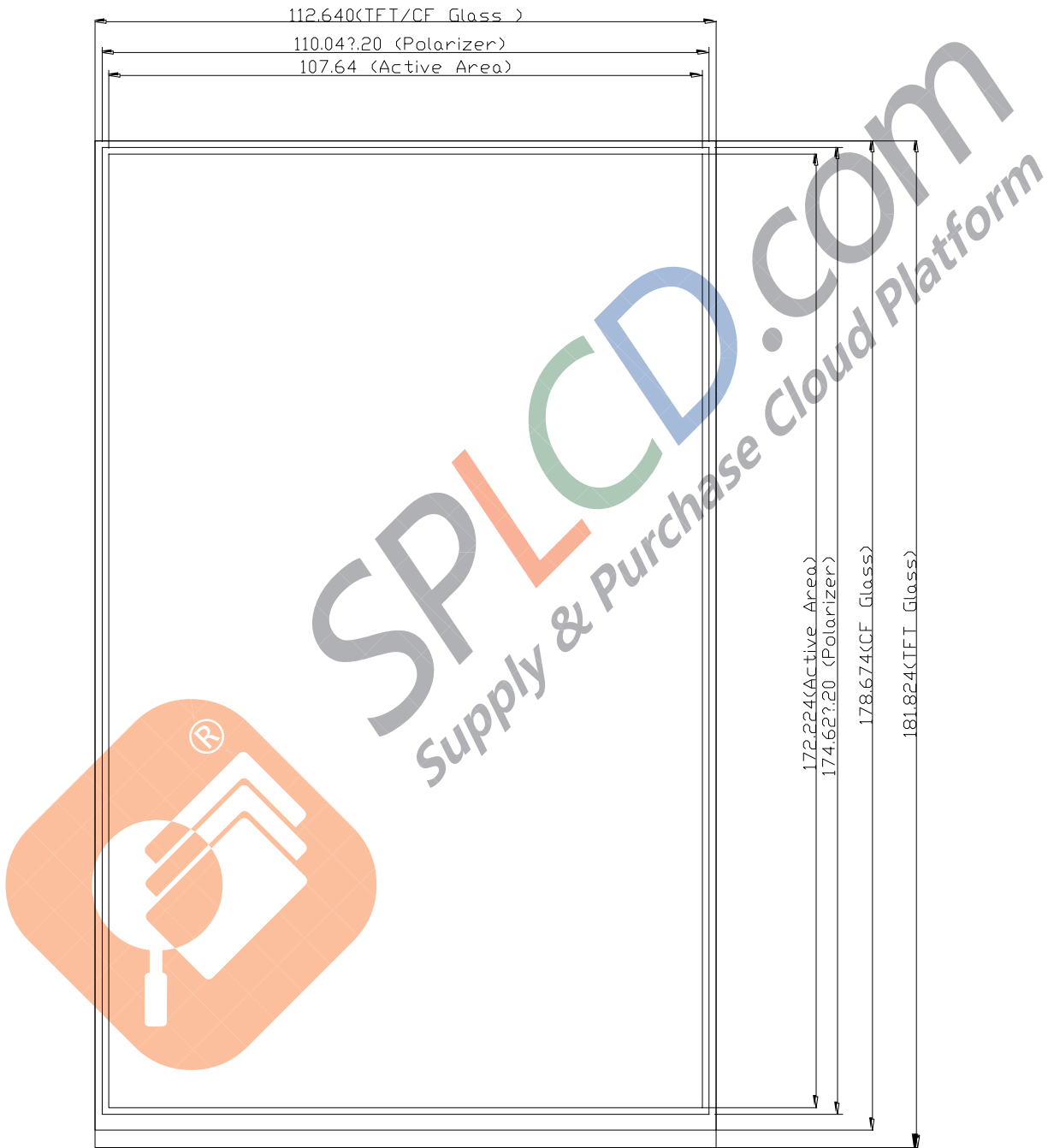

Product Specification

5.4 FPC Outline Dimension

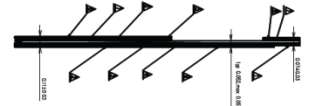
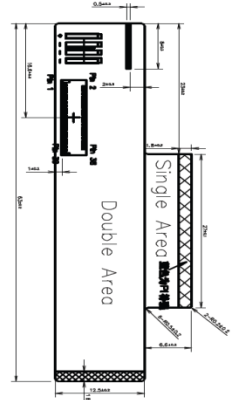

蓝色为0.1mm铜片增强  
内层0.1mm  
总厚度: max0.35mm  
非导电胶

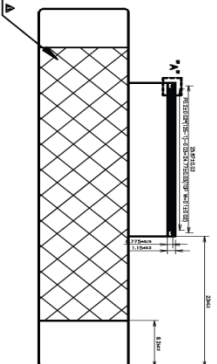

Stack-up Table			
NO	Material	Thickness (um)	Part No. Vendor
1	Al	0.05-0.2	
2	PI	2-4	
3	Adhesive	12.5	
4	CU	12-8	
5	PI	20	
6	CU	12-8	
7	Adhesive	15	
8	PI	12.5	
9	INK	12	
10	Adhesive	30	
11	Spruing	200	

SEI	SEI	SEI	SEI	SEI
SEI	SEI	SEI	SEI	SEI
SEI	SEI	SEI	SEI	SEI
SEI	SEI	SEI	SEI	SEI
SEI	SEI	SEI	SEI	SEI

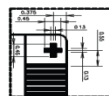

DETAIL 'B' (S4/V)

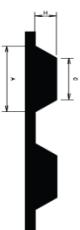

坡利率: 2H/(A-C) ≥ 3.0

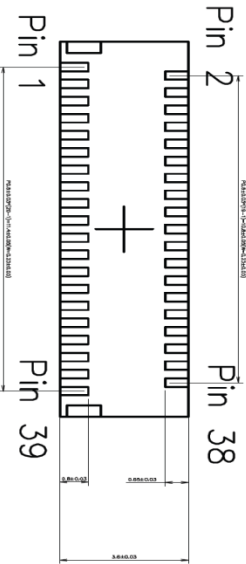

DETAIL 'B' (S4/V)

NOTE  
1. COMPONENTS HEIGHT 1.0mm(Max.), FPCA HEIGHT 1.35mm(Max.);  
2. CON: MSAK24037P9(STM), ON: 20613-039E-01(-PEX);  
3. MIP: Spots Differential Impedance: 100±10% ohm  
4. Halogen Free & RoHS & Reach

TOLERANCE TABLE(±)		REF. DISC.		SIB PART NO.		DESCRIPTION		MATERIAL		COLOR/FINISH		QTY		REMARKS	
DIMENSION	GRADE	GRADE	GRADE	GRADE	GRADE	GRADE	GRADE	GRADE	GRADE	GRADE	GRADE	GRADE	GRADE	GRADE	GRADE
L ≤ 20	0.05	0.1	0.1	0.1	0.2	0.1	0.1	0.1	0.1	0.1	0.1	0.1	0.1	0.1	0.1
20 < L ≤ 50	0.1	0.15	0.2	0.25											
50 < L ≤ 100	0.15	0.2	0.25	0.3											
100 < L ≤ 200	0.2	0.25	0.3	0.5											
200 < L	0.3	0.5	0.8												

由 Autodesk 教育版产品制作

**Product Specification**

**6. RELIABILITY TEST**

Must be accordance with Lenovo RA test items

Test Items	Conditions
Operation Temperature	-20℃ To 60℃
Operating Humidity	5% ~ 90%
Temperature when stored	-30℃ To 80℃
Humidity when stored	5% ~ 90%
MTBF	>10,000POH
If after 10,000 hours, the brightness of the panel is 50% greater than the initial value, the MTBF report and SDA test report should be given to providers.	







SPLCD.com  
Supply & Purchase Cloud Platform

**Product Specification**

**7. Safety & Environment Test Reports**

GP资料已上上传联想系统

1			
2		Required data for Environmental Compliance	Template/Sample
3	CDX Data(Mandatory)	Lenovo Supplier Material Self-Declaration Commodities	 Lenovo Supplier Material Self-Declarat
4		FMD data	 FMD_Import_Sampl el.xls
5	RoHS Test reports(Mandatory)	Lenovo MIDH RoHS Test Reports and MSDS Summary	 Lenovo MDC RoHS Test Reports and
6	MSDS(Conditional)	Lenovo MIDH RoHS Test Reports and MSDS Summary	 Lenovo MDC RoHS Test Reports and
7			
8	Remarks:		
9	1. FMD exemptions can be only applied for 6 month at most.		
	2. REACH test reports are needed under below conditions:		
	a. New suppliers & hazardous substances control is not well performed to meet Lenovo's requirement.		
	b. Hazardous substances is detected or suspected by Lenovo.		
10			

Product Specification

8. Package

8.1. Packing Description

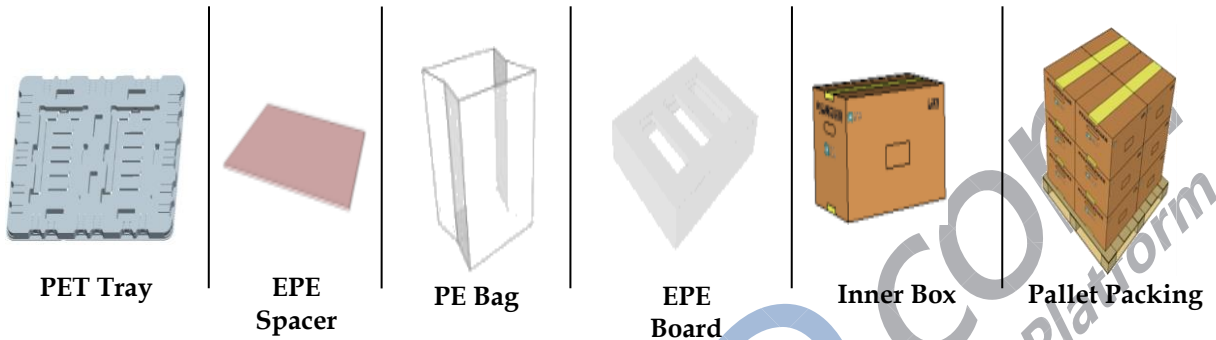

- step 1**
- 将2pcs MDL放入Tray中,每个MDL上放置1pcsSpacer
  - 将20EA装满 MDL & Spacer的Tray依次堆叠,其上放置1EA空Tray,并将堆码21EA Tray放置于PE Bag中
  - 容量:2pcs/Tray
- step 2**
- 将装满Tray的PE Bag放入 Inner Box
  - 上下放置EPE Board
  - 容量:40pcs/Inner Box
- step 3**
- 将 4EA Box码放于Pallet上,共堆叠3层
  - 堆码高度:1015mm (包含Pallet高度)
  - 单Pallet用8ea纸护角防护,捆扎带固定,缠绕膜包裹
  - 容量: 4 EA Box/层,共3层,480pcs MDL/Pallet
- step 4**
- 双排双层码放
  - 容量 :44EA Pallet/Track,21120pcs Panel/Track

Product Specification

8.2. Description of Packing Tray

LCM 2 pcs/1 Tray

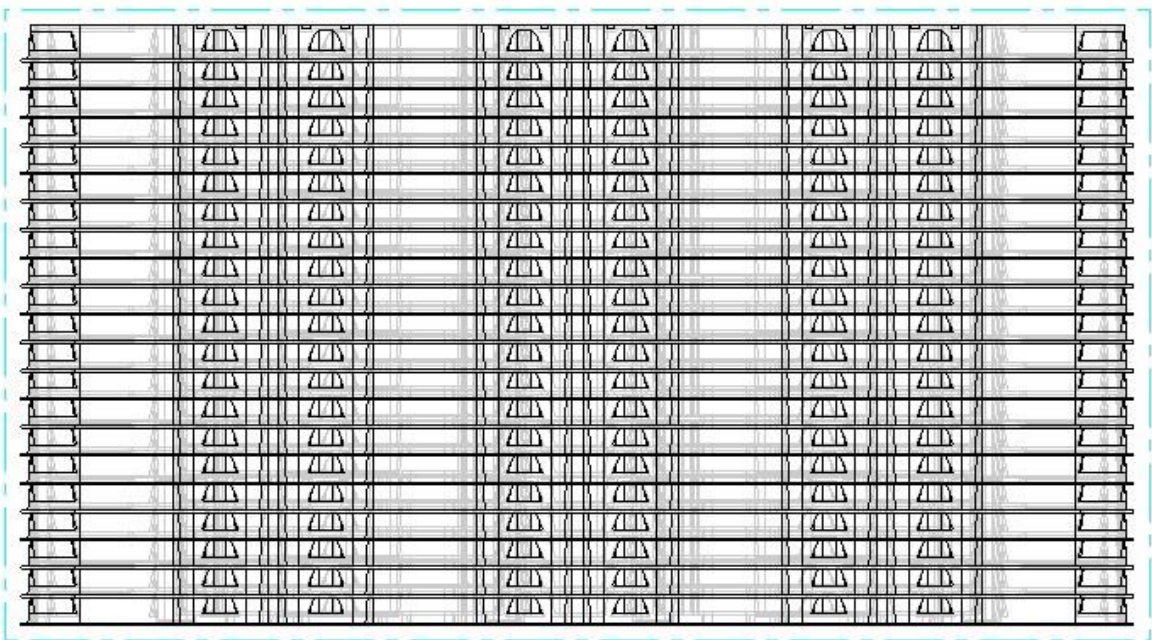
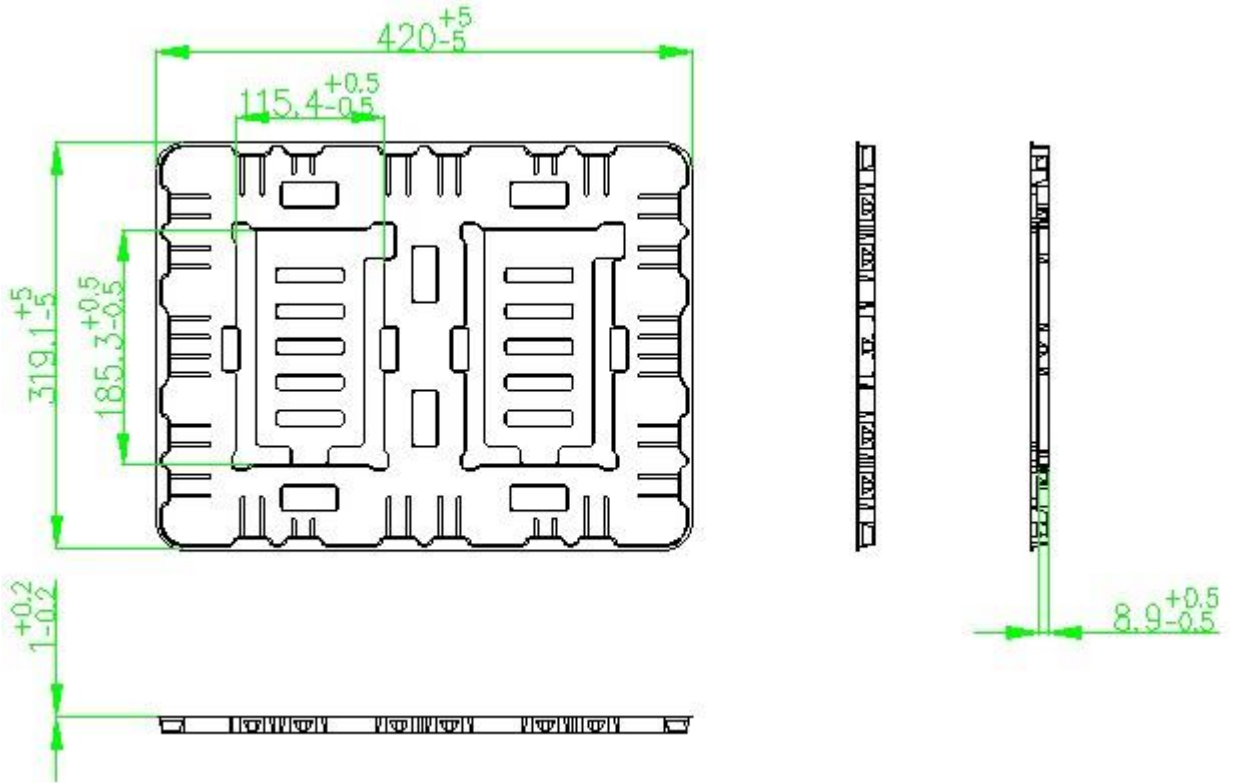

**Product Specification****8.3. Description of Packing Box**

- (1) 16 box (max.) / 1 pallet
- (2) Pallet: 1200(L) X 990(W) X 130(H) mm
- (3) Pallet stack: 1200(L) X 900(W) X 1015(H) mm
- (4) Angle boards: L 850X 60 X 5mm

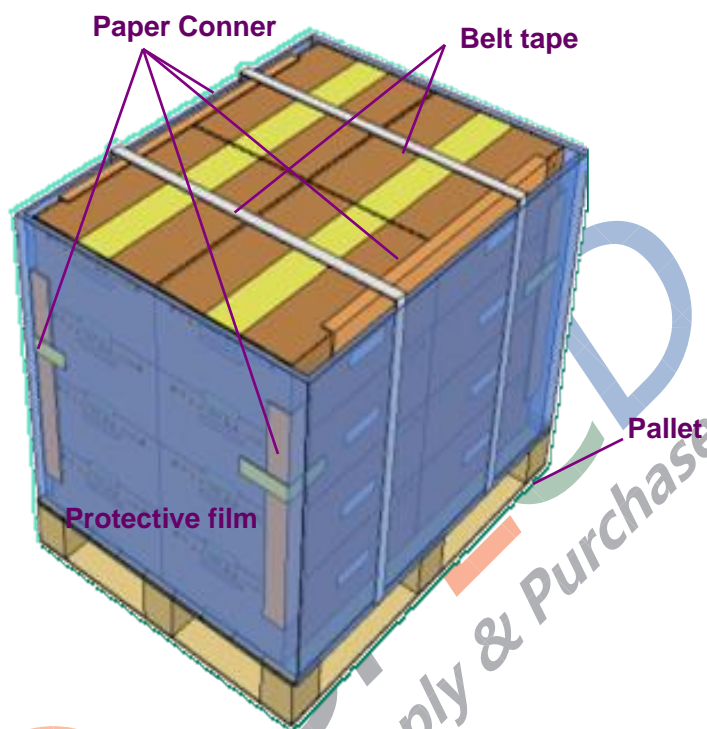



**Product Specification****9. Incoming Inspection Standard****9.1 Defect definition**

Critical defect CR : (Ac=0 Re=1)Bring on or maybe hurt to user.

Major defect MA :

1. Reflect on parts invalidation or unstable;
2. Product function can not meet spde;
3. Cosmetic defect obverously.

Minor defect MI :

1. Do not impact product function & performance;
2. Cosmetic defect unclear;
3. Defect can be repaired easily.

**9.2 Incoming Inspection**

Refer to GB2828. 1-2003, general inspection level II , Qualification level is as below

MA: AQL 0.4      MI: AQL 1.0





**Product Specification**

**10. Checklist**

	Description	Request	Value
Connection	MIPI Impedance	100±10Ω	Yes
	B2B CNT	FR4, 0.3mm	No ,ZIF CNT
	ID Pin	1 <sup>st</sup> source: GND 2 <sup>nd</sup> source: 1.8V(different cell) 2 <sup>nd</sup> source: GND(same cell+IC)	GND
IC	Protection	Shielding tape on IC	Yes
FPC	Bending Area	Not exceed M/F	No
	FPC status	Unfolded while direct bonding	Yes
	GND Area	Need GND area to connect SUS	Yes
	Test Points	Need shielding tape on it	Yes
	Bending Area	Single layer	Yes
SUS	4 Corner side	At lease 1.2mm	No
Panel	Glass Generation	G5?G6?	G8.5
	Cutting Q'ty	panel Q'ty each mother glass	234pcs
	Display mode	VA/IPS	HADS
	Mask Q'ty	Array mask	6
	Pixel Domain	1 or 2?	2
	ITO@C/F	ITO square resistance, thickness	≤1000 Ω/□ , 160A
	Scan direction	Single scan or dual scan	Z inversion
	PS Parameter	Main/Sub PS density and size	Main PS density 1/72,top size 12um ;Sub PS density 70/72, top size 12um;
	Cell gap	Center point	3.35um
	LC injection	Vacuum injection or ODF	ODF
	LC Margin	>6%	-3%~3%,6%
	Pol compensation	A+C/B+B/None compensation film	None compensation film
	UV Glue	Fill out at IC around	Yes
	Pol surf. Treatment	Direct bonding: HC+Glare Air bonding: Haze44+glare(>4inch)	AG25高精细
	Pol position	Direct bonding: pol is higher 0.05mm than M/F Air bonding: pol is lower 0.05mm than M/F	pol is higher 0.119mm than M/F
Package	Surface resistance	10 <sup>4</sup> ~10 <sup>9</sup> Ω	Yes
	Friction voltage	≅ 100V	Yes
	Layer in one Box	<10layer	No, 21layer