







T1/E1/CEPT/ISDN-PRI INTERFACE MODULES

Four Transformer Modules for Dual SMT T1/E1 Ports, Extended Temperature Range



-  Optimized for enhanced EMC performance
-  SMT Dual Port package contains transformers with Optional Common Mode Chokes on both transmit and receive channels
-  Models matched to leading transceiver ICs
-  Patented Interlock Base construction for high reliability
-  Recognized to UL 1950
-  Isolation Voltage: 1500 Vrms

Electrical Specifications @ 25°C

Part Number		Turns Ratio ² (Pri:Sec ± 2%)		Secondary OCL @ 25°C (mH MIN)	Cw/w (pF MAX)	DCR Pri (Ω MAX)	Package/ Schematic	Primary Pins	
w/CMC	wo/CMC	Transmit	Receive					Transmit	Receive
EXTENDED TEMPERATURE RANGE MODELS¹ – OPERATING TEMPERATURE -40°C TO +85°C									
T1176	TX1321	1CT:2.4CT	1CT:1CT	1.20	35	0.80	WAT/2	1-3 & 10-12	21-19 & 18-16
TX1192	TX1322	1CT:2.42CT	1CT:2.42CT	1.20	25	0.80	WAT/1	4-6 & 10-12	1-3 & 7-9
TX1193	TX1323	1CT:2CT	1CT:1CT	1.20	35	0.80	WAT/1	4-6 & 10-12	24-22 & 18-16
TX1194	TX1324	1CT:1.15CT	1CT:1.15CT	1.20	35	0.80	WAT/1	4-6 & 10-12	1-3 & 7-9
TX1195	TX1325	1CT:1.41CT	1CT:1.41CT	1.20	30	0.80	WAT/2	1-3 & 10-12	21-19 & 18-16
TX1196	TX1326	1CT:2CT	1CT:2CT	1.20	25	0.80	WAT/1	4-6 & 10-12	1-3 & 7-9
TX1197	TX1327	1CT:2CT	1CT:2CT	1.20	25	0.80	WAT/2	1-3 & 10-12	21-19 & 18-16
TX1198	TX1328	1CT:2.3CT	1CT:1CT	1.20	35	0.80	WAT/1	4-6 & 10-12	24-22 & 18-16
TX1199	TX1329	1CT:1.36CT	1CT:2CT	1.20	35	0.80	WAT/1	4-6 & 10-12	24-22 & 18-16
TX1300	TX1330	1CT:1.36CT	1CT:1CT	1.20	35	0.80	WAT/1	4-6 & 10-12	24-22 & 18-16
TX1301	TX1331	1CT:1.15CT	1CT:2CT	1.20	35	0.80	WAT/1	4-6 & 10-12	1-3 & 7-9

Note: RoHS-6 compliant parts can be ordered by adding a "NL" suffix to the part number (i.e. T1176 becomes T1176NL).

Mechanical

Schematics

WAT

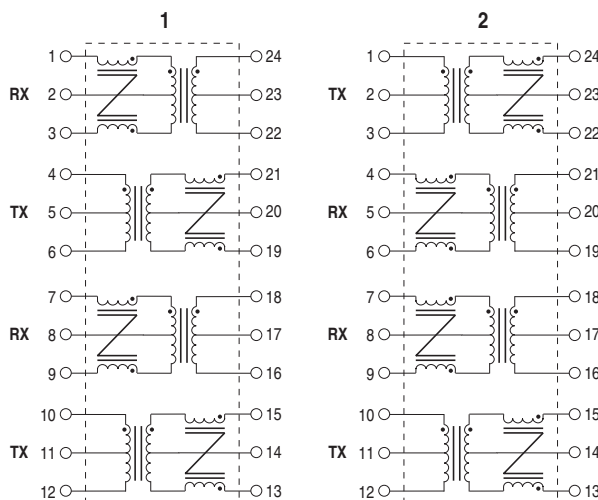
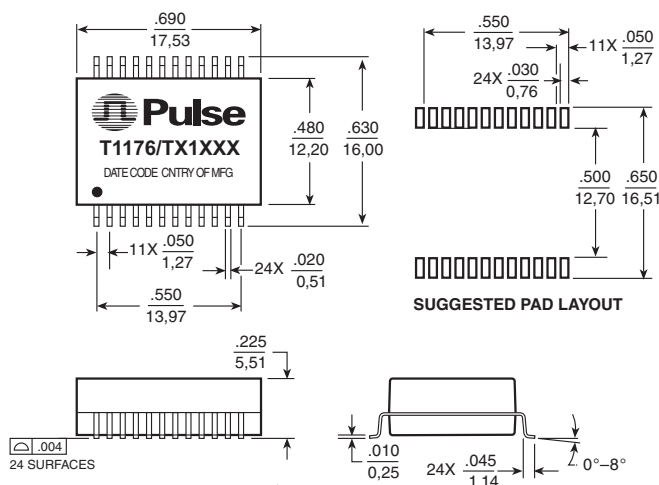

Weight 4.0 grams
Tape & Reel250/reel
Tube30/tube

Dimensions: $\frac{\text{Inches}}{\text{mm}}$
Unless otherwise specified, all tolerances are $\pm \frac{.010}{0.25}$

T1/E1/CEPT/ISDN-PRI INTERFACE MODULES

Four Transformer Modules for Dual SMT T1/E1 Ports, Extended Temperature Range



Notes From Tables

- Extended Temperature Range Models** — For extended temperature range transformers (-40°C to +85°C operating temperature range), OCL (Open Circuit Inductance) is specified at both -40°C and +25°C. At -40°C, OCL is 600 µH minimum. All other parameters are specified at +25°C only.
- Turns ratio is specified primary: secondary (CT = Center Tap).
- Standard packaging for the surface mount package is anti-static tubes. Optional Tape & Reel packaging can be ordered by adding a "T" suffix to the part number, (i.e. T1176T).

Application Notes

- Flammability** — Materials used in the products are recognized as UL94-VO approved. Products meet the requirements of IEC 695-2-2 (Needle Flame Test).
- Balance Characteristics** — The transformers meet the requirements for longitudinal balance of FCC part 68.
- Common Mode Rejection Ratio** — the CMRR for all transformers is better than 50 dB at 1 MHz. A typical test circuit is shown below.
- Crosstalk Attenuation** — In the packages which contain transmit and receive transformers side by side, sufficient crosstalk attenuation is achieved by the inherent characteristics of the toroid cores as well as by their proper positioning. The crosstalk attenuation is typically 65 dB or better. This result was established with the test circuit shown below.
- Return Loss** — ITU-T G.703 and European national regulatory documents specify minimum return loss levels. The transformers will allow these limits to be complied within the situations where they are applicable.

Frequency	50-100 KHz	100 KHz-2 MHz	2-3 MHz
Return Loss			
XMIT	9 dB	15 dB	11 dB
RCV	12 dB	18 dB	14 dB

- General Information** — The transformers are specifically designed for use in 1.544 Mbps (T1), 2.048 Mbps (CEPT) and ISDN Primary rate (PRI) interface applications. They are matched to the majority of the line interface transceiver ICs currently available. Use of the proper transformer allows the interface circuit to comply with ITU-T G.703 and other standards regarding pulse waveform, return loss, and balance.

For More Information:

Pulse Worldwide Headquarters	Pulse Northern Europe	Pulse Southern Europe	Pulse China Headquarters	Pulse North China	Pulse South Asia	Pulse North Asia
12220 World Trade Drive San Diego, CA 92128 U.S.A. www.pulseeng.com TEL: 858 674 8100 FAX: 858 674 8262	3 Huxley Road Surrey Research Park Guildford, Surrey GU2 5RE United Kingdom TEL: 44 1483 401700 FAX: 44 1483 401701	Zone Industrielle F-39270 Orgelet France TEL: 33 3 84 35 04 04 FAX: 33 3 84 25 46 41	No. 1 Industrial District Changan, Dongguan China TEL: 86 769 85538070 FAX: 86 769 85538870	Room 1503 XinYin Building No. 888 YiShan Road Shanghai 200233 China TEL: 86 21 54643211/2 FAX: 86 21 54643210	150 Kampong Ampat #07-01/02 KA Centre Singapore 368324 TEL: 65 6287 8998 FAX: 65 6280 0080	No. 26 Kao Ching Road Yang Mei Chen Taoyuan Hsien Taiwan, R. O. C. TEL: 886 3 4641811 FAX: 886 3 4641911

Performance warranty of products offered on this data sheet is limited to the parameters specified. Data is subject to change without notice. Other brand and product names mentioned herein may be trademarks or registered trademarks of their respective owners.

© Copyright, 2006. Pulse Engineering, Inc. All rights reserved.