

# TX14/15 SERIES CONNECTORS

## 1.27mm (.050") Contact Spacing, PCB-to-PCB Connectors

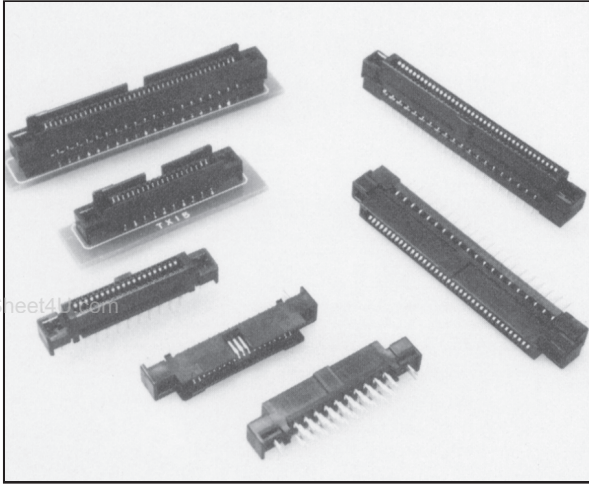

### FEATURES

- Greater stability and reliability due to extra long contact wipe
- Leaf-type contact design resists damage from twisting
- First-to-make-last-to-break contact action
- Nine optional stacking heights: 12 to 20mm (.472 to .787"), 1mm (.039") intervals
- 16 optional polarization keying positions
- Available with/without hook pin

Connector Profile (Ref.)

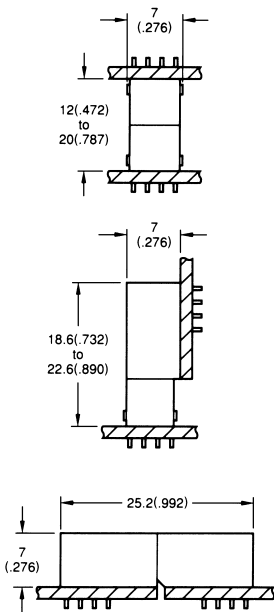

The leaf-type design (non-pin) contact of this board-to-board connector is superior in reliability and stability due to its resistance to twisting. The receptacle (TX14) and plug (TX15) combination can be arranged in horizontal, vertical or parallel connections. Straight through hole and right angle through hole types are available. With 5 variable heights of the straight through hole type, this series is particularly adaptable to parallel board assemblies spaced within a range of 12 to 20mm (.472-.787"). These connectors are ideal for all types of office/factory automation equipment, computers, and other electronic equipment.

### GENERAL SPECIFICATIONS

Number of Contacts	30 to 80, 100, 120, 140, 160, 180, 200
Contact Spacing	1.27mm (.050"), Double row
Current Rating	0.5 Amps
Dielectric Withstanding Voltage	500 VAC r.m.s. (for one minute)
Insulation Resistance	100 megohms min.
Contact Resistance	40 milliohms max.
Operating Temperature	-40°C to +80°C
PCB Thickness	1.6mm (0.063")

### MATERIALS AND FINISHES

Description	Materials/Finishes
Contact	Copper Alloy Connecting area: Gold 0.1µm (.000004") min. over Nickel Terminal area: Tin plating
Insulator	Glass-filled Nylon (UL94V-0, Black)
Spacer	Glass-filled Nylon (UL94V-0, Black)
Hook Pin	Phosphor Bronze/Tin plating

### ORDERING INFORMATION

TX\*\* - \*\* \* \* \*\* - \* \* 1

Series TX14/TX15

No. of Contacts 30, 40, 50, 60, 70, 80, 100, 120, 140, 160, 180, 200

Connector Type P – Plug R – Receptacle

Mating Height Code (ST) – 6 to 10 (LT) – None

Termination Style ST – Straight Through Hole LT – Right Angle Through Hole

Mounting Ears M – With Mounting Ears Blank – Without Mounting Ears

Hook Pin H – With Hook Pin N – Without Hook Pin

Finish Code 1 – Connecting Area: Gold 0.1µm (.000004") min. over Nickel Terminal Area: Tin plating

Dimensions in mm (inches).

# TX14/15 SERIES CONNECTORS

1.27mm (.050") Contact Spacing, PCB-to-PCB Connectors

## TX14 • RECEPTACLE

- STRAIGHT THROUGH HOLE (With Mounting Ears)  
TX14-\*\*R-\*ST-M\*1

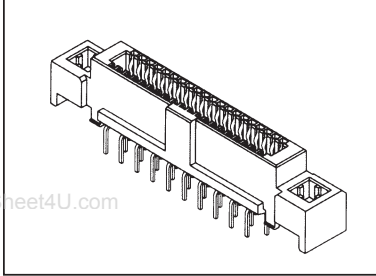

- STRAIGHT THROUGH HOLE (Without Mounting Ears)  
TX14-\*\*R-\*ST-N1

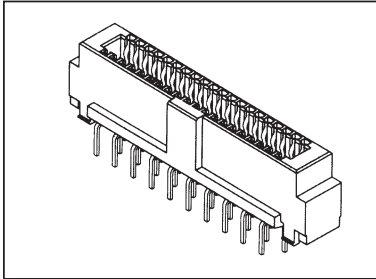

- ANGLE THROUGH HOLE (With Mounting Ears)  
TX14-\*\*R-LT-M\*1

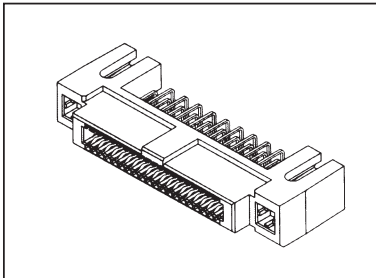

## TX15 • PLUG

- STRAIGHT THROUGH HOLE (With Mounting Ears)  
TX15-\*\*P-\*ST-M\*1

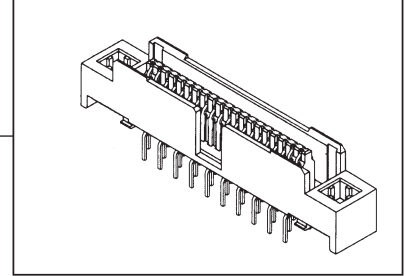

- STRAIGHT THROUGH HOLE (Without Mounting Ears)  
TX15-\*\*P-\*ST-N\*1

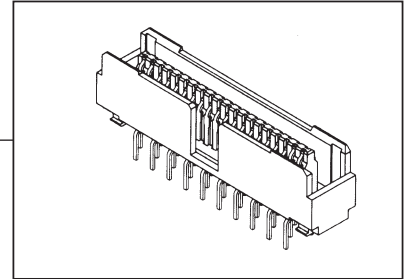

- ANGLE THROUGH HOLE (With Mounting Ears)  
TX15-\*\*P-LT-M\*1

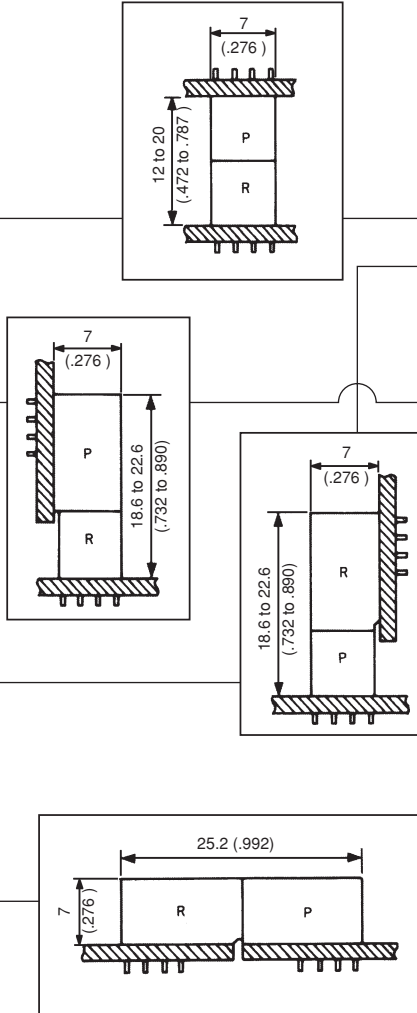
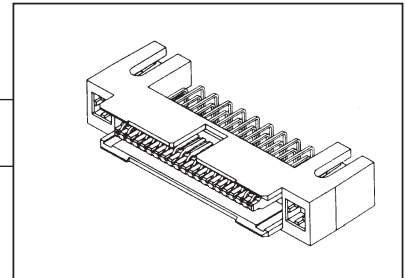

Note: R – Receptacle, P – Plug

Receptacle

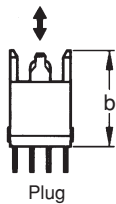
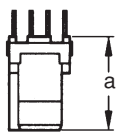

Insulator Height (Straight Through Hole)

Mating Height Code		6	7	8	9	10
Receptacle	a	8.9 (.350)	9.9 (.390)	10.9 (.429)	11.9 (.469)	12.9 (.508)
Plug	b	9.2 (.362)	10.2 (.402)	11.2 (.441)	12.2 (.480)	13.2 (.520)

Parallel Board-to-Board Distance

		Receptacle				
Mating Height Code		6	7	8	9	10
Plug	6	12 (.472)	13 (.512)	14 (.551)	15 (.591)	16 (.630)
	7	13 (.512)	14 (.551)	15 (.591)	16 (.630)	17 (.669)
	8	14 (.551)	15 (.591)	16 (.630)	17 (.669)	18 (.709)
	9	15 (.591)	16 (.630)	17 (.669)	18 (.709)	19 (.748)
	10	16 (.630)	17 (.669)	18 (.709)	19 (.748)	20 (.787)

Dimensions and specifications subject to change without notice.

# TX14/15 SERIES CONNECTORS

## 1.27mm (.050") Contact Spacing, PCB-to-PCB Connectors

### TX14 • RECEPTACLE

#### STRAIGHT THROUGH HOLE (ST) TYPE WITH MOUNTING EARS (M): 30 TO 120 CONTACTS

- With Hook Pin: TX14-\*\*-□ST-MH1
- Without Hook Pin: TX14-\*\*-□ST-MN1

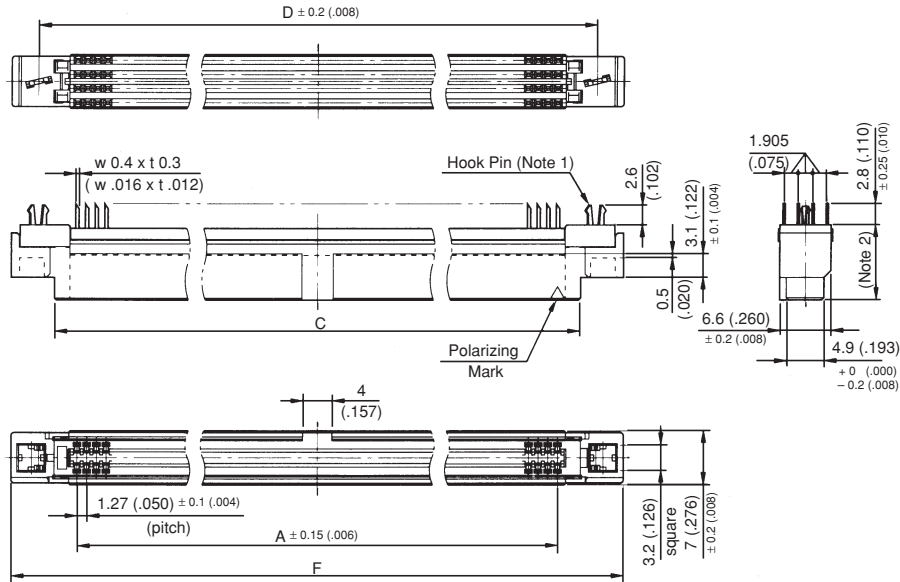

Note 1: Shown with hook pins.

Note 2: Insulator height. Refer to Mating Height Table.

#### PCB Hole Patterns (Ref.)

##### 30, 50, 70 Contacts

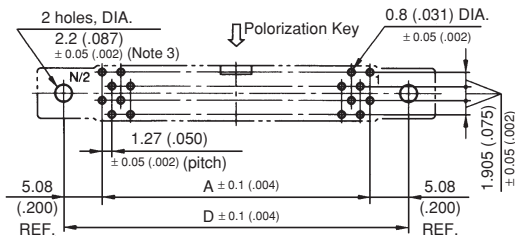

##### 40, 60, 80, 100, 120 Contacts

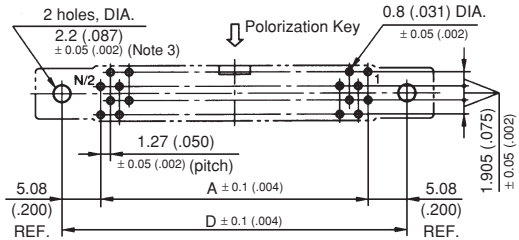

Note 3: Holes on both sides are needed for hook pin type.

No. of Contacts	Part Number	A	C +0.1 (+.004) -0.3 (-.012)	D	F ± 0.4 (.016)
30	TX14- 30R-□ST-M*1	17.78 (.700)	23.78 (.936)	27.94 (1.100)	34.98 (1.377)
40	TX14- 40R-□ST-M*1	24.13 (.950)	30.13 (1.186)	34.29 (1.350)	41.33 (1.627)
50	TX14- 50R-□ST-M*1	30.48 (1.200)	36.48 (1.436)	40.64 (1.600)	47.68 (1.877)
60	TX14- 60R-□ST-M*1	36.83 (1.450)	42.83 (1.686)	46.99 (1.850)	54.03 (2.127)
70	TX14- 70R-□ST-M*1	43.18 (1.700)	49.18 (1.936)	53.34 (2.100)	60.38 (2.377)
80	TX14- 80R-□ST-M*1	49.53 (1.950)	55.53 (2.186)	59.69 (2.350)	66.73 (2.627)
100	TX14-100R-□ST-M*1	62.23 (2.450)	68.23 (2.686)	72.39 (2.850)	79.43 (3.127)
120	TX14-120R-□ST-M*1	74.93 (2.950)	80.93 (3.186)	85.09 (3.350)	92.13 (3.627)

□: Add mating height code. Refer to Mating Height Table.

\*: Add hook pin code. H – With hook pin, N – Without hook pin

Dimensions in mm (inches).

# TX14/15 SERIES CONNECTORS

## 1.27mm (.050") Contact Spacing, PCB-to-PCB Connectors

### TX14 • RECEPTACLE STRAIGHT THROUGH HOLE (ST) TYPE WITH MOUNTING EARS (M): 140 TO 200 CONTACTS

- With Hook Pin: TX14-\*\*-R-□ST-MH1
- Without Hook Pin: TX14-\*\*-R-□ST-MN1

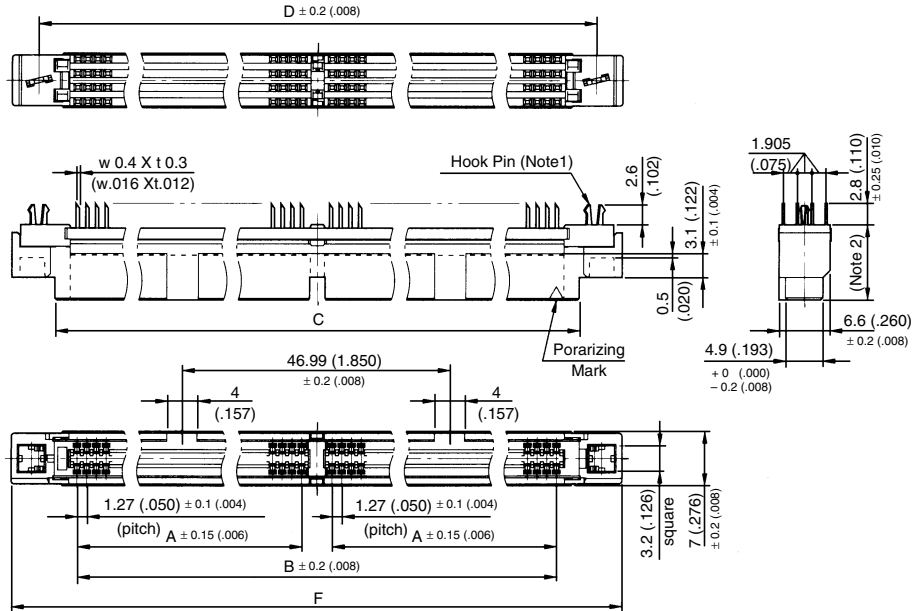

Note 1: Shown with hook pins.  
Note 2: Insulator height. Refer to Mating Height Table.

### PCB Hole Patterns (Ref.)

140, 180 Contacts

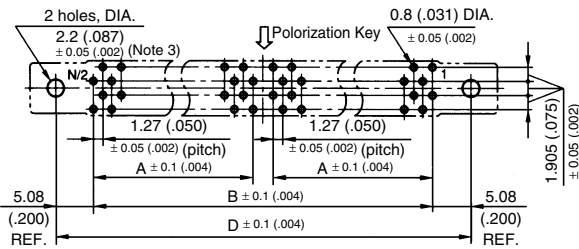

160, 200 Contacts

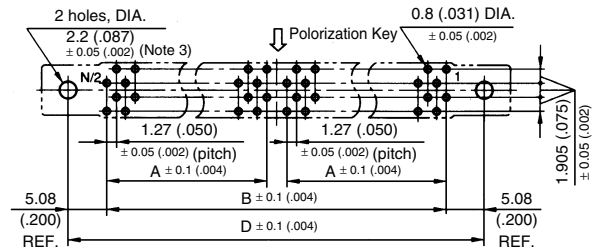

Note 3: Holes on both sides are needed for hook pin type.

No. of Contacts	Part Number	A	B	C $+0.1 (+.004)$ $-0.3 (-.012)$	D	F $\pm 0.4 (.016)$
140	TX14-140R-□ST-M*1	43.18 (1.700)	90.17 (3.550)	96.17 (3.786)	100.33 (3.950)	107.37 (4.227)
160	TX14-160R-□ST-M*1	49.53 (1.950)	102.87 (4.050)	108.87 (4.286)	113.03 (4.450)	120.07 (4.727)
180	TX14-180R-□ST-M*1	55.88 (2.200)	115.57 (4.550)	121.57 (4.786)	125.73 (4.950)	132.77 (5.227)
200	TX14-200R-□ST-M*1	62.23 (2.450)	128.27 (5.050)	134.27 (5.286)	138.43 (5.450)	145.47 (5.727)

□: Add mating height code. Refer to Mating Height Table.

\*: Add hook pin code. H – With hook pin, N – Without hook pin

Dimensions in mm (inches).

# TX14/15 SERIES CONNECTORS

## 1.27mm (.050") Contact Spacing, PCB-to-PCB Connectors

### TX14 • RECEPTACLE STRAIGHT THROUGH HOLE (ST) TYPE WITHOUT MOUNTING EARS (N): 30 TO 120 CONTACTS

• Without Hook Pin: TX14-\*\*R-□ST-N1

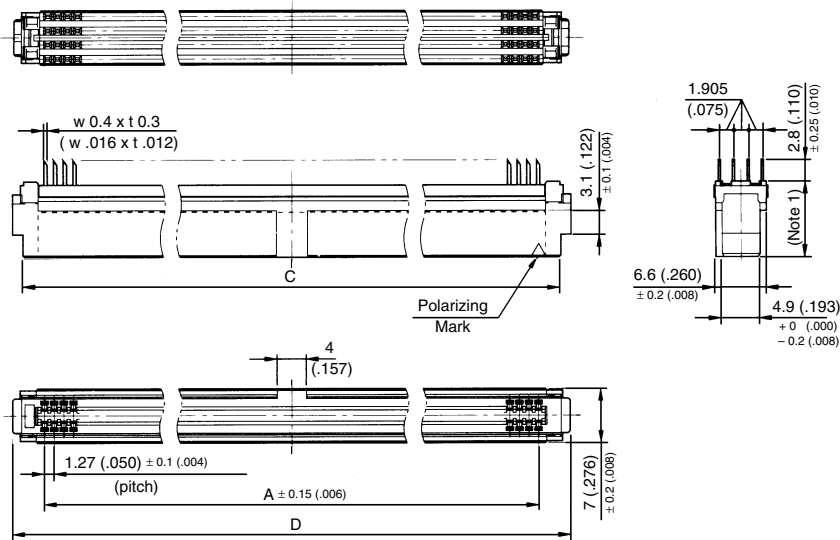

Note 1: Insulator height. Refer to Mating Height Table.

#### PCB Hole Patterns (Ref.)

30, 50, 70 Contacts

40, 60, 80, 100, 120 Contacts

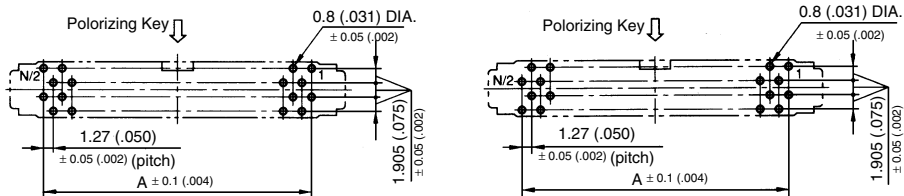

No. of Contacts	Part Number	A	C +0.1 (+.004) -0.3 (-.012)	D ± 0.4 (.016)
30	TX14- 30R-□ST-N1	17.78 ( .700)	23.78 ( .936)	26.38 (1.039)
40	TX14- 40R-□ST-N1	24.13 ( .950)	30.13 (1.186)	32.73 (1.289)
50	TX14- 50R-□ST-N1	30.48 (1.200)	36.48 (1.436)	39.08 (1.539)
60	TX14- 60R-□ST-N1	36.83 (1.450)	42.83 (1.686)	45.43 (1.789)
70	TX14- 70R-□ST-N1	43.18 (1.700)	49.18 (1.936)	51.78 (2.039)
80	TX14- 80R-□ST-N1	49.53 (1.950)	55.53 (2.186)	58.13 (2.289)
100	TX14-100R-□ST-N1	62.23 (2.450)	68.23 (2.686)	70.83 (2.789)
120	TX14-120R-□ST-N1	74.93 (2.950)	80.93 (3.186)	83.53 (3.289)

□: Add mating height code. Refer to Mating Height Table.

Dimensions in mm (inches).

Dimensions in mm (inches).

# TX14/15 SERIES CONNECTORS

## 1.27mm (.050") Contact Spacing, PCB-to-PCB Connectors

### TX14 • RECEPTACLE

#### STRAIGHT THROUGH HOLE (ST) TYPE WITHOUT MOUNTING EARS (N): 140 TO 200 CONTACTS

• Without Hook Pin: TX14-\*\*R-□ST-N1

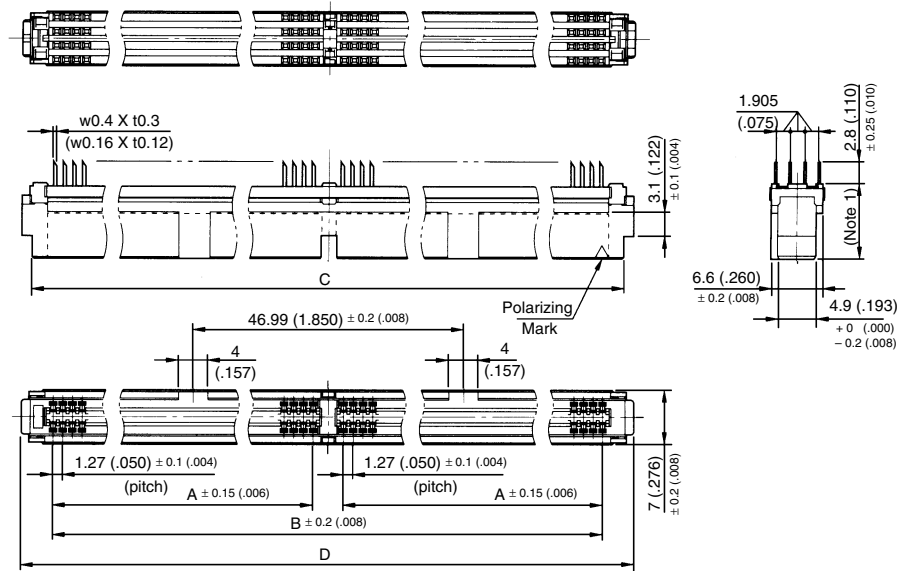

Note 1: Insulator height. Refer to Mating Height Table.

#### PCB Hole Patterns (Ref.)

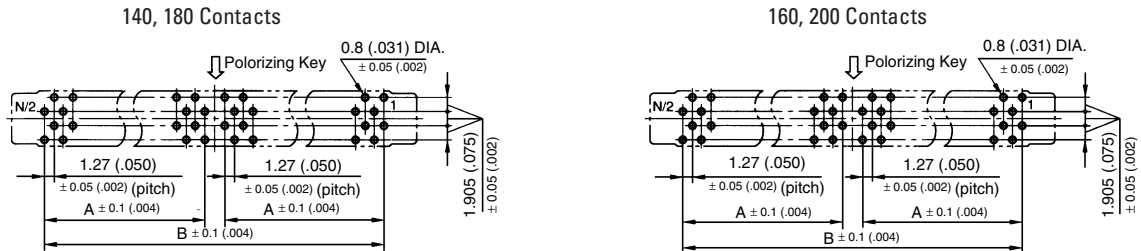

No. of Contacts	Part Number	A	B	C +0.1 (+.004) -0.3 (-.012)	D ± 0.4 (.016)
140	TX14-140R-□ST-N1	43.18 (1.700)	90.17 (3.550)	96.17 (3.786)	98.77 (3.889)
160	TX14-160R-□ST-N1	49.53 (1.950)	102.87 (4.050)	108.87 (4.286)	111.47 (4.389)
180	TX14-180R-□ST-N1	55.88 (2.200)	115.57 (4.550)	121.57 (4.786)	124.17 (4.889)
200	TX14-200R-□ST-N1	62.23 (2.450)	128.27 (5.050)	134.27 (5.286)	136.87 (5.389)

□: Add mating height code. Refer to Mating Height Table.

Dimensions in mm (inches).

# TX14/15 SERIES CONNECTORS

## 1.27mm (.050") Contact Spacing, PCB-to-PCB Connectors

### TX14 • RECEPTACLE RIGHT ANGLE THROUGH HOLE (LT) TYPE WITH MOUNTING EARS (M): 30 TO 120 CONTACTS

- With Hook Pin: TX14-\*\*R-LT-MH1
- Without Hook Pin: TX14-\*\*R-LT-MN1

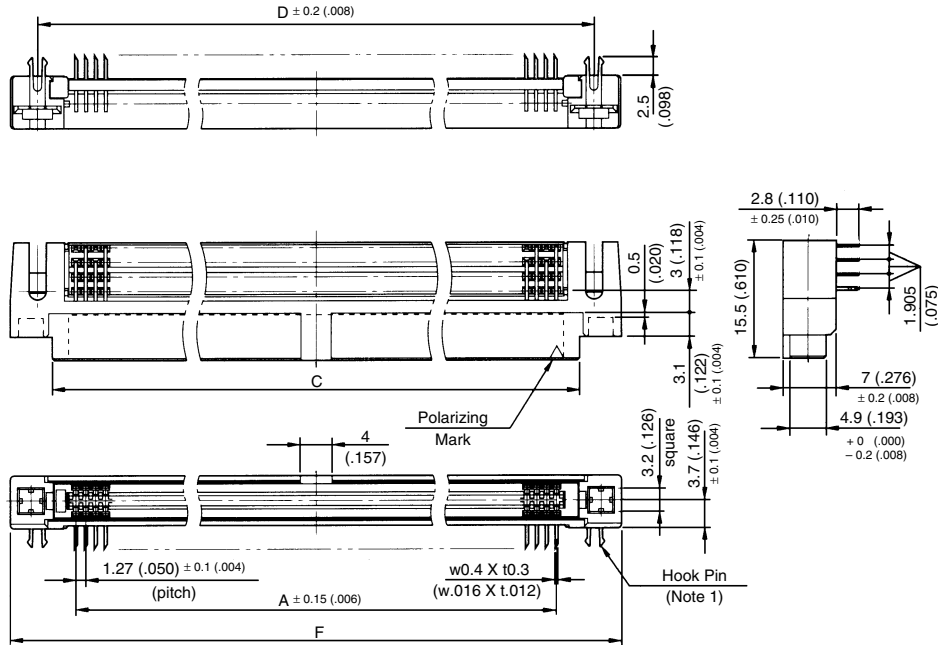

Note 1: Shown with hook pins.

### PCB Hole Patterns (Ref.)

30, 50, 70 Contacts

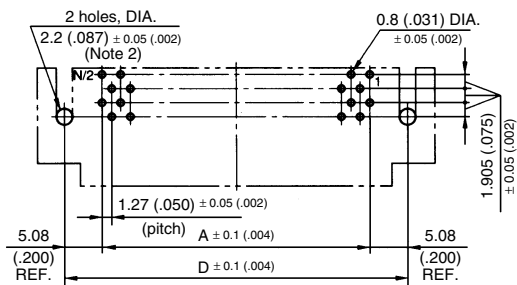

40, 60, 80, 100, 120 Contacts

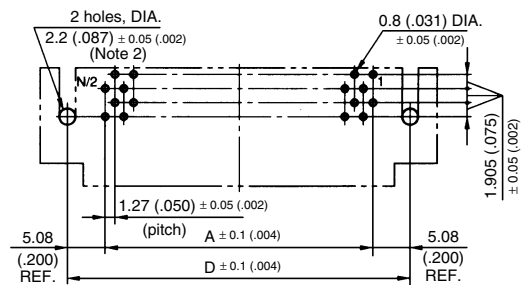

Note 2: Applicable screws for without-hook-pin type: M2

No. of Contacts	Part Number	A	C $+0.1$ (+.004) $-0.3$ (-.012)	D	F $\pm 0.4$ (.016)
30	TX14- 30R-LT-M*1	17.78 ( .700)	23.78 ( .936)	27.94 (1.100)	34.98 (1.377)
40	TX14- 40R-LT-M*1	24.13 ( .950)	30.13 (1.186)	34.29 (1.350)	41.33 (1.627)
50	TX14- 50R-LT-M*1	30.48 (1.200)	36.48 (1.436)	40.64 (1.600)	47.68 (1.877)
60	TX14- 60R-LT-M*1	36.83 (1.450)	42.83 (1.686)	46.99 (1.850)	54.03 (2.127)
70	TX14- 70R-LT-M*1	43.18 (1.700)	49.18 (1.936)	53.34 (2.100)	60.38 (2.377)
80	TX14- 80R-LT-M*1	49.53 (1.950)	55.53 (2.186)	59.69 (2.350)	66.73 (2.627)
100	TX14- 100R-LT-M*1	62.23 (2.450)	68.23 (2.686)	72.39 (2.850)	79.43 (3.127)
120	TX14- 120R-LT-M*1	74.93 (2.950)	80.93 (3.186)	85.09 (3.350)	92.13 (3.627)

\*: Add hook pin code. H – With hook pin, N – Without hook pin

Dimensions in mm (inches).

Dimensions in mm (inches).

# TX14/15 SERIES CONNECTORS

## 1.27mm (.050") Contact Spacing, PCB-to-PCB Connectors

### TX14 • RECEPTACLE

#### RIGHT ANGLE THROUGH HOLE (LT) TYPE WITH MOUNTING EARS (M): 140 TO 200 CONTACTS

- With Hook Pin: TX14-\*\*R-LT-MH1
- Without Hook Pin: TX14-\*\*R-LT-MN1

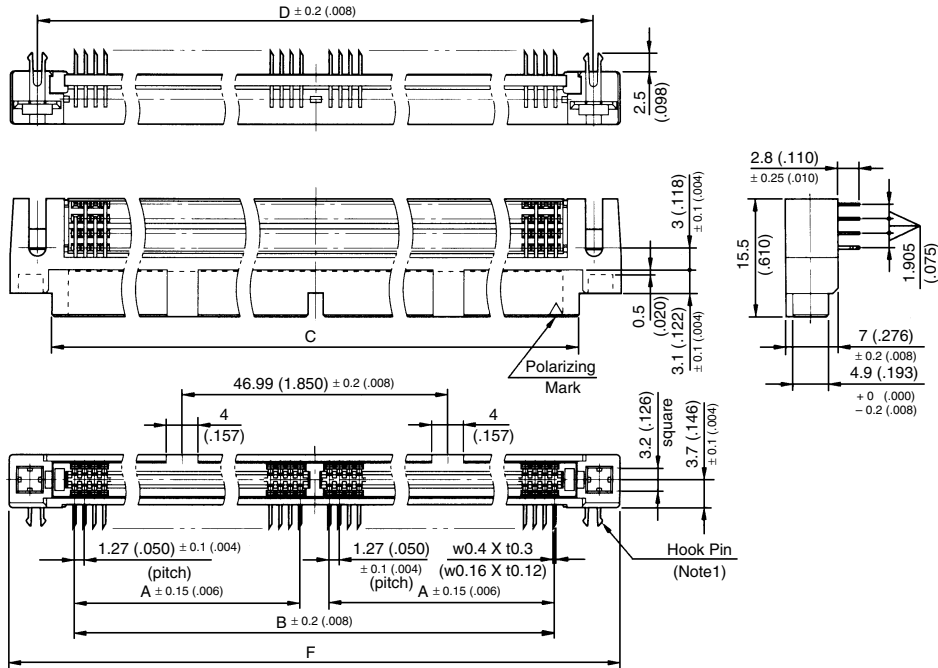

Note 1: Shown with hook pins.

### PCB Hole Patterns (Ref.)

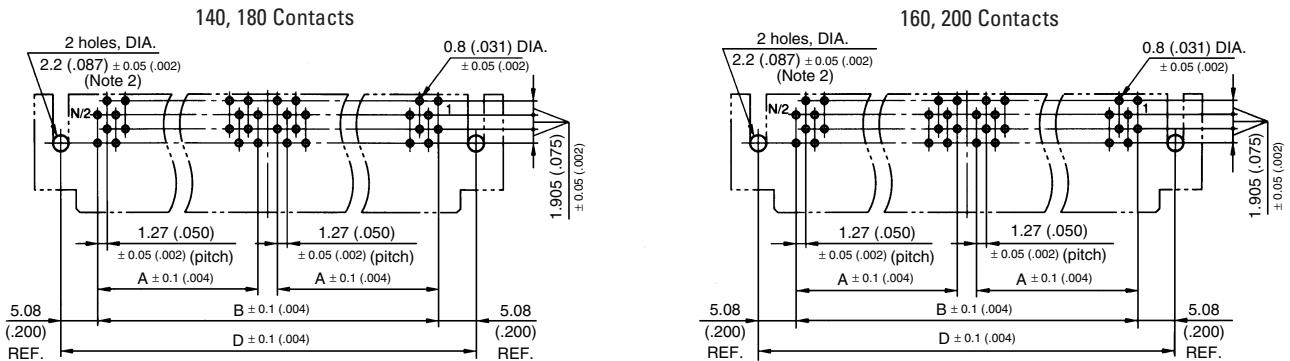

Note 2: Applicable screws for without-hook-pin type: M2

No. of Contacts	Part Number	A	B	C $+0.1 (+.004)$ $-0.3 (-.012)$	D	F $\pm 0.4 (.016)$
140	TX14- 140R-LT-M*1	43.18 (1.700)	90.17 (3.550)	96.17 (3.786)	100.33 (3.950)	107.37 (4.227)
160	TX14- 160R-LT-M*1	49.53 (1.950)	102.87 (4.050)	108.87 (4.286)	113.03 (4.450)	120.07 (4.727)
180	TX14- 180R-LT-M*1	55.88 (2.200)	115.57 (4.550)	121.57 (4.786)	125.73 (4.950)	132.77 (5.227)
200	TX14- 200R-LT-M*1	62.23 (2.450)	128.27 (5.050)	134.27 (5.286)	138.43 (5.450)	145.47 (5.727)

\*: Add hook pin code. H – With hook pin, N – Without hook pin

Dimensions in mm (inches).



# TX14/15 SERIES CONNECTORS

## 1.27mm (.050") Contact Spacing, PCB-to-PCB Connectors

### TX15 • PLUG

#### STRAIGHT THROUGH HOLE (ST) TYPE WITH MOUNTING EARS (M): 30 TO 120 CONTACTS

- With Hook Pin: TX15-\*\*P-□ST-MH1
- Without Hook Pin: TX15-\*\*P-□ST-MN1

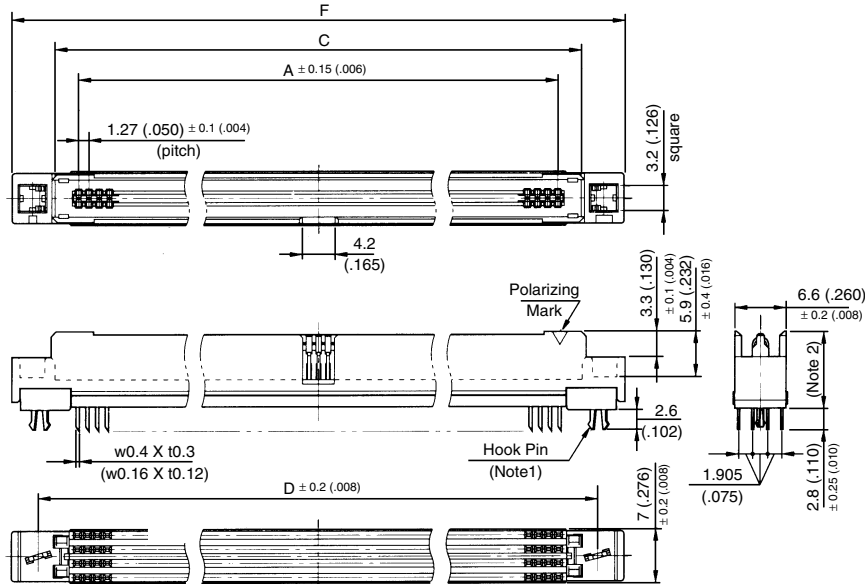

Note 1: Shown with hook pins.  
 Note 2: Insulator height. Refer to Mating Height Table.

#### PCB Hole Patterns (Ref.)

30, 50, 70 Contacts

40, 60, 80, 100, 120 Contacts

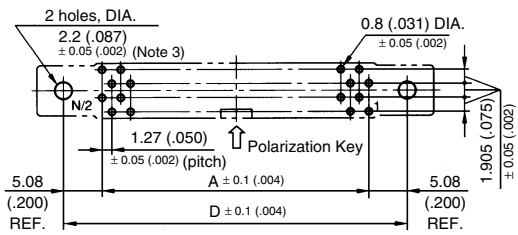
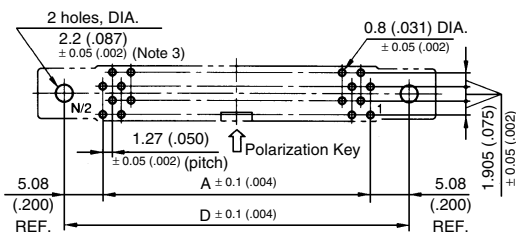

Note 3: Holes on both sides are needed for hook pin type.

No. of Contacts	Part Number	A	C +0.3 (+.012) -0.1 (-.004)	D	F ± 0.4 (.016)
30	TX15- 30P-□ST-M*1	17.78 (.700)	23.98 (.944)	27.94 (1.100)	34.98 (1.377)
40	TX15- 40P-□ST-M*1	24.13 (.950)	30.33 (1.194)	34.29 (1.350)	41.33 (1.627)
50	TX15- 50P-□ST-M*1	30.48 (1.200)	36.68 (1.444)	40.64 (1.600)	47.68 (1.877)
60	TX15- 60P-□ST-M*1	36.83 (1.450)	43.03 (1.694)	46.99 (1.850)	54.03 (2.127)
70	TX15- 70P-□ST-M*1	43.18 (1.700)	49.38 (1.944)	53.34 (2.100)	60.38 (2.377)
80	TX15- 80P-□ST-M*1	49.53 (1.950)	55.73 (2.194)	59.69 (2.350)	66.73 (2.627)
100	TX15-100P-□ST-M*1	62.23 (2.450)	68.43 (2.694)	72.39 (2.850)	79.43 (3.127)
120	TX15-120P-□ST-M*1	74.93 (2.950)	81.13 (3.194)	85.09 (3.350)	92.13 (3.627)

□: Add mating height code. Refer to Mating Height Table.

\*: Add hook pin code. H – With hook pin, N – Without hook pin

Dimensions in mm (inches).

# TX14/15 SERIES CONNECTORS

## 1.27mm (.050") Contact Spacing, PCB-to-PCB Connectors

### TX15 • PLUG

#### STRAIGHT THROUGH HOLE (ST) TYPE WITH MOUNTING EARS (M): 140 TO 200 CONTACTS

- With Hook Pin: TX15-\*\*-□-ST-MH1
- Without Hook Pin: TX15-\*\*-□-ST-MN1

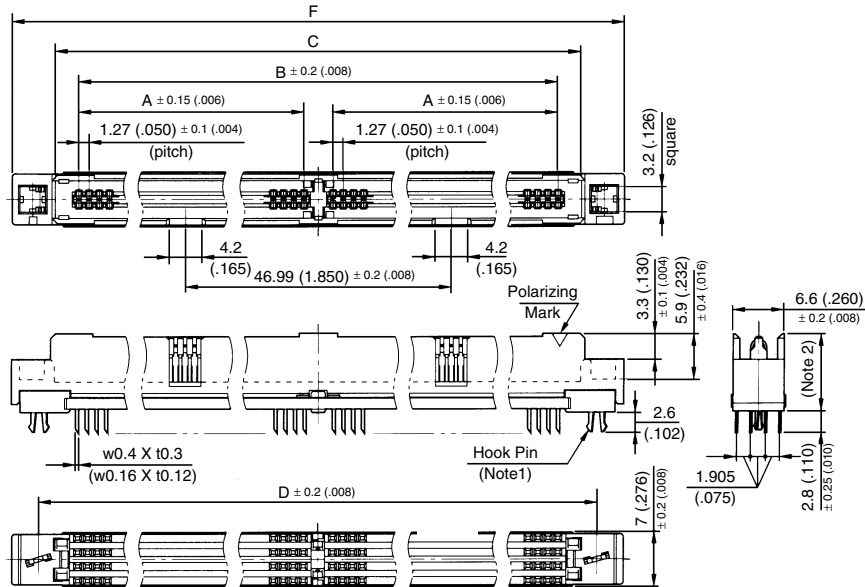

Note 1: Shown with hook pins.

Note 2: Insulator height. Refer to Mating Height Table.

#### PCB Hole Patterns (Ref.)

##### 140, 180 Contacts

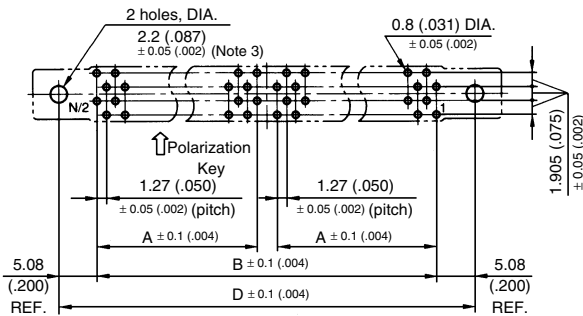

##### 160, 200 Contacts

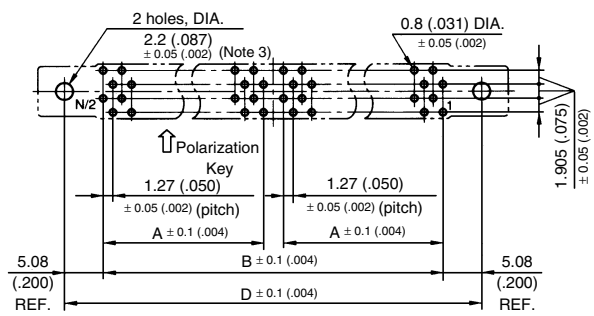

Note 3: Holes on both sides are needed for hook pin type.

No. of Contacts	Part Number	A	B	C +0.3 (+.012) -0.1 (-.004)	D	F ± 0.4 (.016)
140	TX15-140P-□-ST-M*1	43.18 (1.700)	90.17 (3.550)	96.37 (3.794)	100.33 (3.950)	107.37 (4.227)
160	TX15-160P-□-ST-M*1	49.53 (1.950)	102.87 (4.050)	109.07 (4.294)	113.03 (4.450)	120.07 (4.727)
180	TX15-180P-□-ST-M*1	55.88 (2.200)	115.57 (4.550)	121.77 (4.794)	125.73 (4.950)	132.77 (5.227)
200	TX15-200P-□-ST-M*1	62.23 (2.450)	128.27 (5.050)	134.47 (5.294)	138.43 (5.450)	145.47 (5.727)

□: Add mating height code. Refer to Mating Height Table.

\*: Add hook pin code. H – With hook pin, N – Without hook pin

Dimensions in mm (inches).

# TX14/15 SERIES CONNECTORS

## 1.27mm (.050") Contact Spacing, PCB-to-PCB Connectors

### TX15 • PLUG

#### STRAIGHT THROUGH HOLE (ST) TYPE WITHOUT MOUNTING EARS (N): 30 TO 120 CONTACTS

• Without Hook Pin: TX15-\*\*P-□ST-N1

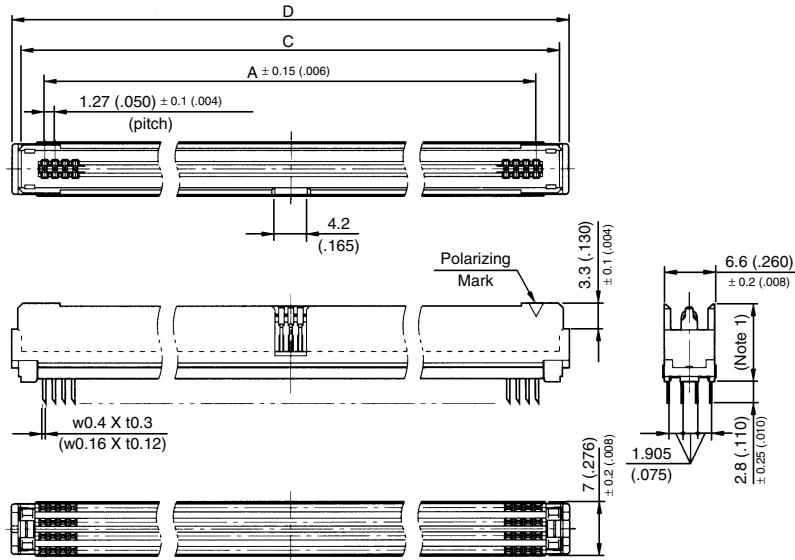

Note 1: Insulator height. Refer to Mating Height Table.

#### PCB Hole Patterns (Ref.)

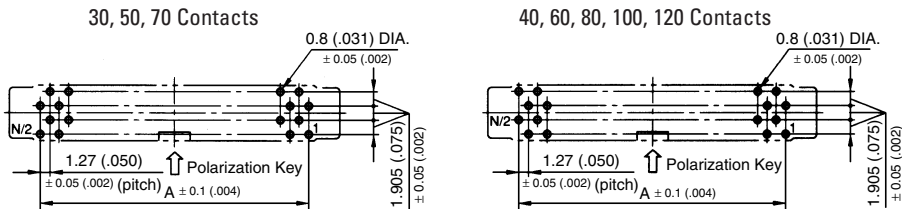

No. of Contacts	Part Number	A	C +0.3 (+.012) -0.1 (-.004)	D ± 0.4 (.016)
30	TX15- 30P-□ST-N1	17.78 (.700)	23.98 (.944)	26.38 (1.039)
40	TX15- 40P-□ST-N1	24.13 (.950)	30.33 (1.194)	32.73 (1.289)
50	TX15- 50P-□ST-N1	30.48 (1.200)	36.68 (1.444)	39.08 (1.539)
60	TX15- 60P-□ST-N1	36.83 (1.450)	43.03 (1.694)	45.43 (1.789)
70	TX15- 70P-□ST-N1	43.18 (1.700)	49.38 (1.944)	51.78 (2.039)
80	TX15- 80P-□ST-N1	49.53 (1.950)	55.73 (2.194)	58.03 (2.289)
100	TX15-100P-□ST-N1	62.23 (2.450)	68.43 (2.694)	70.83 (2.789)
120	TX15-120P-□ST-N1	74.93 (2.950)	81.13 (3.194)	83.53 (3.289)

□: Add mating height code. Refer to Mating Height Table.

Dimensions in mm (inches).

# TX14/15 SERIES CONNECTORS

## 1.27mm (.050") Contact Spacing, PCB-to-PCB Connectors

### TX15 • PLUG

#### STRAIGHT THROUGH HOLE (ST) TYPE WITHOUT MOUNTING EARS (N): 140 TO 200 CONTACTS

• Without Hook Pin: TX15-\*\*P-□ST-N1

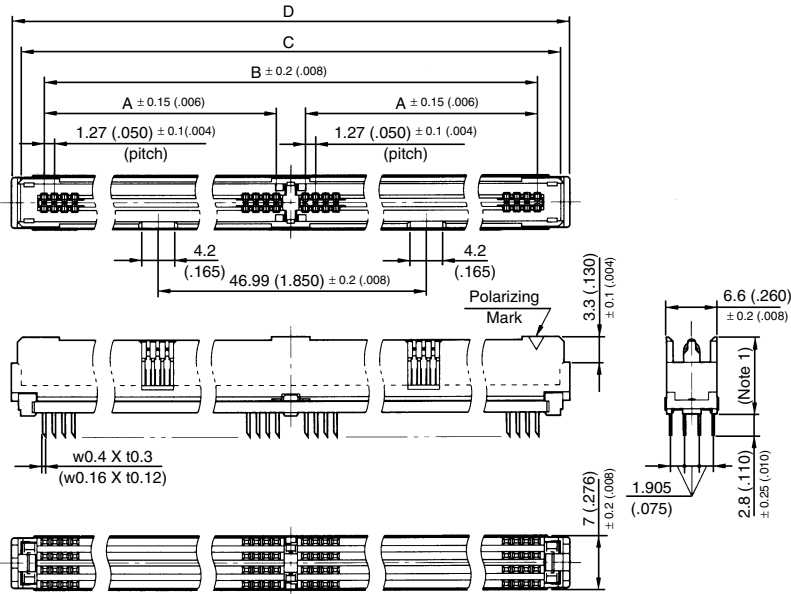

Note 1: Insulator height. Refer to Mating Height Table.

### PCB Hole Patterns (Ref.)

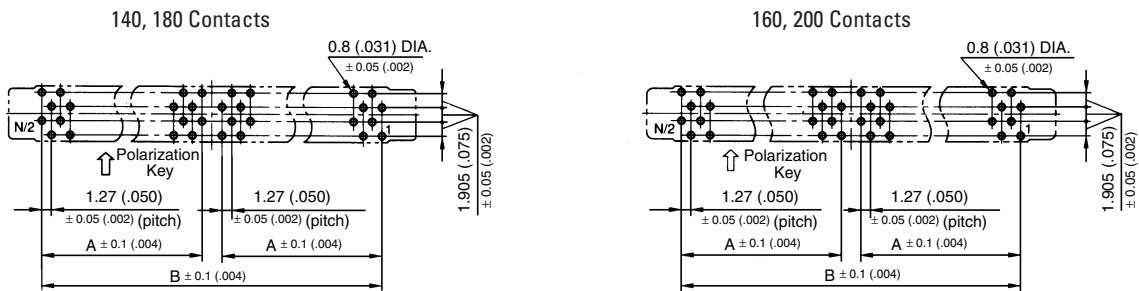

No. of Contacts	Part Number	A	B	C +0.3 (+.012) -0.1 (-.004)	D ± 0.4 (.016)
140	TX15-140P-□ST-N1	43.18 (1.700)	90.17 (3.550)	96.37 (3.794)	98.77 (3.889)
160	TX15-160P-□ST-N1	49.53 (1.950)	102.87 (4.050)	109.07 (4.294)	111.47 (4.389)
180	TX15-180P-□ST-N1	55.88 (2.200)	115.57 (4.550)	121.77 (4.794)	124.17 (4.889)
200	TX15-200P-□ST-N1	62.23 (2.450)	128.27 (5.050)	134.47 (5.294)	136.87 (5.389)

□: Add mating height code. Refer to Mating Height Table.

Dimensions in mm (inches).

# TX14/15 SERIES CONNECTORS

## 1.27mm (.050") Contact Spacing, PCB-to-PCB Connectors

### TX15 • PLUG

#### RIGHT ANGLE THROUGH HOLE (LT) TYPE WITH MOUNTING EARS (M): 30 TO 120 CONTACTS

- With Hook Pin: TX15-\*\*P-LT-MH1
- Without Hook Pin: TX15-\*\*P-LT-MN1

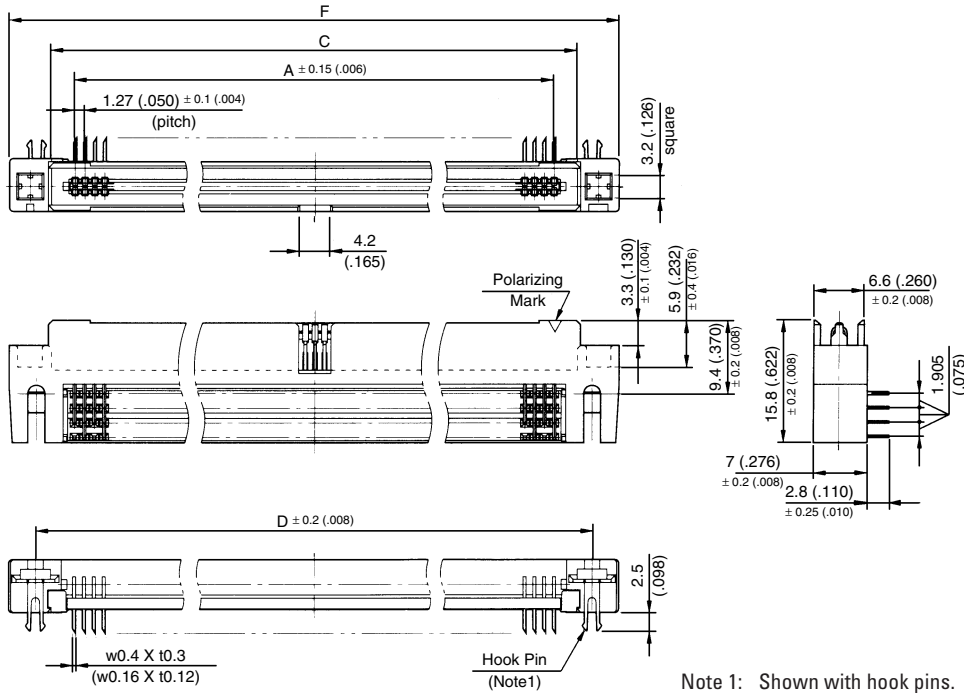

Note 1: Shown with hook pins.

#### PCB Hole Patterns (Ref.)

##### 30, 50, 70 Contacts

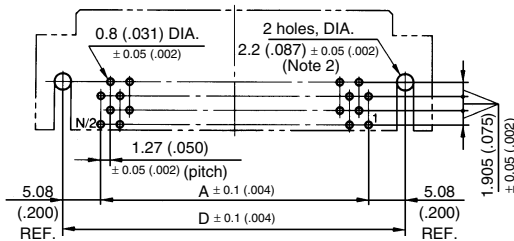

##### 40, 60, 80, 100, 120 Contacts

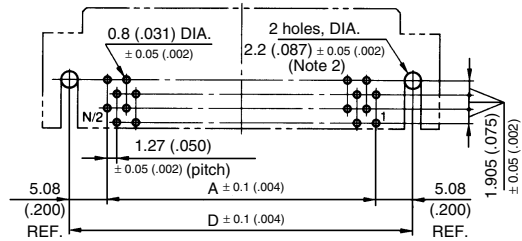

Note 2: Applicable screws for without-hook-pin type: M2

No. of Contacts	Part Number	A	C +0.3 (+0.12) -0.1 (-0.04)	D	F ± 0.4 (.016)
30	TX15- 30P-LT-M*1	17.78 ( .700)	23.98 ( .944)	27.94 (1.100)	34.98 (1.377)
40	TX15- 40P-LT-M*1	24.13 ( .950)	30.33 (1.194)	34.29 (1.350)	41.33 (1.627)
50	TX15- 50P-LT-M*1	30.48 (1.200)	36.68 (1.444)	40.64 (1.600)	47.68 (1.877)
60	TX15- 60P-LT-M*1	36.83 (1.450)	43.03 (1.694)	46.99 (1.850)	54.03 (2.127)
70	TX15- 70P-LT-M*1	43.18 (1.700)	49.38 (1.944)	53.34 (2.100)	60.38 (2.377)
80	TX15- 80P-LT-M*1	49.53 (1.950)	55.73 (2.194)	59.69 (2.350)	66.73 (2.627)
100	TX15-100P-LT-M*1	62.23 (2.450)	68.43 (2.694)	72.39 (2.850)	79.43 (3.127)
120	TX15-120P-LT-M*1	74.93 (2.950)	81.13 (3.194)	85.09 (3.350)	92.13 (3.627)

\*: Add hook pin code. H – With hook pin, N – Without hook pin

Dimensions in mm (inches).

# TX14/15 SERIES CONNECTORS

## 1.27mm (.050") Contact Spacing, PCB-to-PCB Connectors

### TX15 • PLUG

#### RIGHT ANGLE THROUGH HOLE (LT) TYPE WITH MOUNTING EARS (M): 140 TO 200 CONTACTS

- With Hook Pin: TX15-\*\*P-LT-MH1
- Without Hook Pin: TX15-\*\*P-LT-MN1

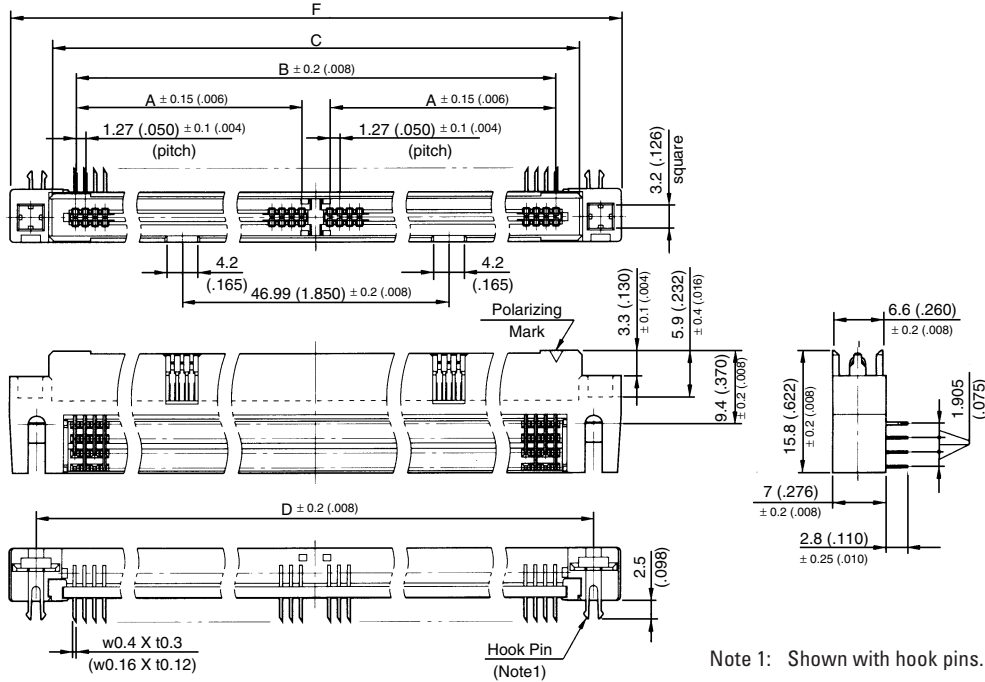

Note 1: Shown with hook pins.

#### PCB Hole Patterns (Ref.)

##### 140, 180 Contacts

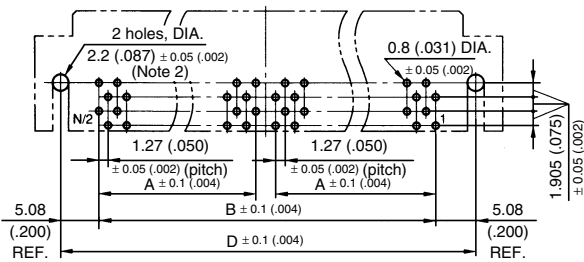

##### 160, 200 Contacts

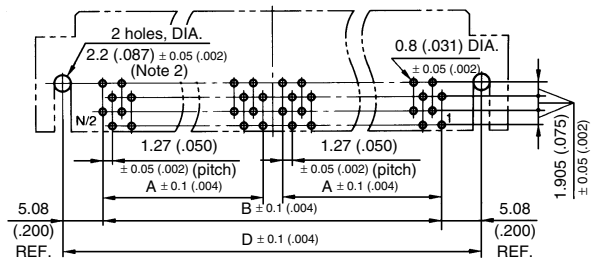

Note 2: Applicable screws for without-hook-pin type: M2

No. of Contacts	Part Number	A	B	C +0.3 (+0.012) -0.1 (-0.004)	D	F ± 0.4 (.016)
140	TX15-140P-LT-M*1	43.18 (1.700)	90.17 (3.550)	96.37 (3.794)	100.33 (3.950)	107.37 (4.227)
160	TX15-160P-LT-M*1	49.53 (1.950)	102.87 (4.050)	109.07 (4.294)	113.03 (4.450)	120.07 (4.727)
180	TX15-180P-LT-M*1	55.88 (2.200)	115.57 (4.550)	121.77 (4.794)	125.73 (4.950)	132.77 (5.227)
200	TX15-200P-LT-M*1	62.23 (2.450)	128.27 (5.050)	134.47 (5.294)	138.43 (5.450)	145.47 (5.727)

\*: Add hook pin code. H – With hook pin, N – Without hook pin

Dimensions in mm (inches).