



SCR FOR OVERVOLTAGE PROTECTION

FEATURES

- High surge current capability
- High di/dt rating
- High stability and reliability

DESCRIPTION

The TYN512 and TYN1012 Family of Silicon Controlled Rectifiers uses a high performance glass passivated technology.

This general purpose Family of Silicon Controlled Rectifiers is designed for overvoltage protection in crowbar circuits application.

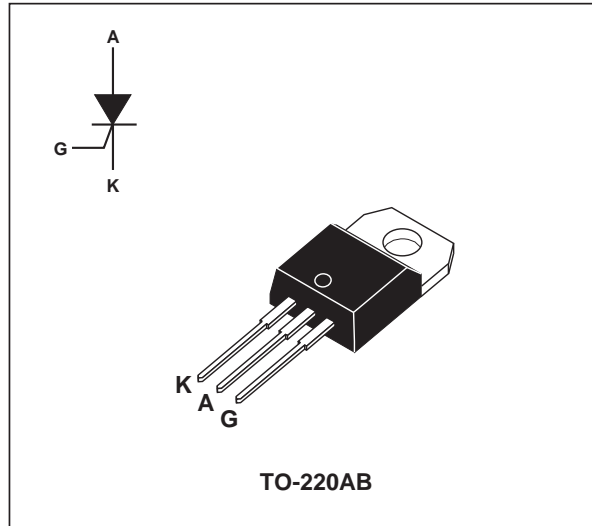

ABSOLUTE RATINGS (limiting values)

Symbol	Parameter	Value	Unit
$I_{T(RMS)}$	RMS on-state current (180° conduction angle, single phase circuit)	$T_c = 110^\circ\text{C}$ 12	A
$I_{T(AV)}$	Average on-state current (180° conduction angle, single phase circuit)	$T_c = 110^\circ\text{C}$ 8	A
I_{TSM}	Non repetitive surge peak on-state current (T_j initial = 25°C)	$t_p = 8.3\text{ms}$ 315	A
		$t_p = 10\text{ms}$ 300	
I^2t	I^2t value	$t_p = 10\text{ms}$ 450	A^2s
I_{TM}	Non repetitive surge peak on-state current (T_j initial = 25°C) Exponential pulse wave form	$t_p = 1\text{ms}$ 750	A
di/dt	Critical rate of rise of on-state current Gate supply: $I_G = 100\text{mA}$ $di_G/dt = 1\text{A}/\mu\text{s}$	100	$\text{A}/\mu\text{s}$
T_{stg} T_j	Storage and operating junction temperature range	-40 to +150 -40 to +125	°C
T_I	Maximum lead soldering temperature during 10s at 4.5mm from case	260	°C

Symbol	Parameter	TYP		Unit
		512	1012	
V_{DRM} V_{RRM}	Repetitive peak off-state voltage $T_j = 125^\circ\text{C}$	50	100	V

TYP512 TYP1012

www.DataSheet4U.com

THERMAL RESISTANCE

Symbol	Parameter	Value	Unit
Rth (j-a)	Junction to ambient	60	°C/W
Rth (j-c) DC	Junction to case for DC	1.3	°C/W

GATE CHARACTERISTICS (maximum values)

$P_{G(AV)} = 1W$ $P_{GM} = 10W$ ($t_p = 20\mu s$) $I_{FGM} = 4A$ ($t_p = 20\mu s$) $V_{RGM} = 5V$

ELECTRICAL CHARACTERISTICS

Symbol	Test conditions	Value	Unit		
I_{GT}	$V_D = 12V$ (DC) $R_L = 33\Omega$ $T_j = 25^\circ C$	MAX.	30 mA		
V_{GT}	$V_D = 12V$ (DC) $R_L = 33\Omega$ $T_j = 25^\circ C$	MAX.	1.5 V		
V_{GD}	$V_D = V_{DRM}$ $R_L = 3.3k\Omega$ $T_j = 125^\circ C$	MIN.	0.2 V		
tgt	$V_D = V_{DRM}$ $I_G = 200mA$ $di_G/dt = 1.5A/\mu s$ $T_j = 25^\circ C$	TYP.	1 μs		
I_L	$I_G = 1.2I_{GT}$ $T_j = 25^\circ C$	TYP.	60 mA		
I_H	$I_T = 500mA$ Gate open $T_j = 25^\circ C$	MAX.	50 mA		
V_{TM}	$I_{TM} = 50A$ $t_p = 380\mu s$ $T_j = 25^\circ C$	MAX.	1.5 V		
I_{DRM} I_{RRM}	V_{DRM} rated V_{RRM} rated $T_j = 25^\circ C$	MAX.	0.01 mA		
		$T_j = 125^\circ C$	MAX.	2	
dV/dt	Linear slope up to $V_D = 67\% V_{DRM}$ gate open $T_j = 125^\circ C$	MIN.	200 $V/\mu s$		
tq	$V_D = 67\% V_{DRM}$ $I_{TM} = 50A$ $V_R = 25V$ $di_{TM}/dt = 30 A/\mu s$ $dV_D/dt = 50V/\mu s$ $T_j = 125^\circ C$	TYP.	100 μs		

Fig. 1: Maximum average power dissipation versus average on-state current.

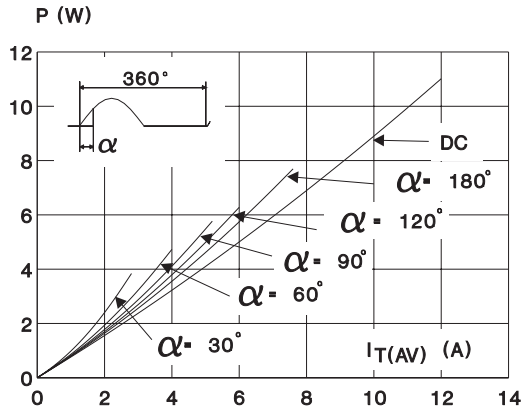

Fig. 2: Correlation between maximum average power dissipation and maximum allowable temperatures (Tamb and Tcase) for different thermal resistances (Rth).

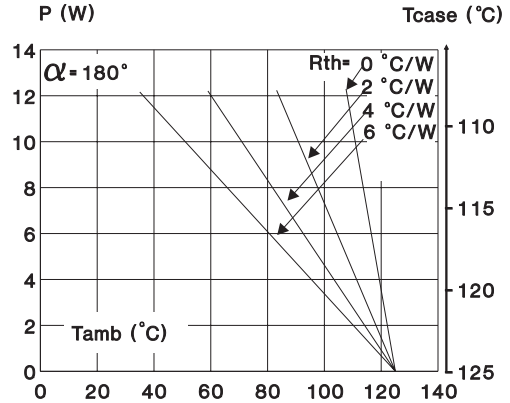

Fig. 3: Average on-state current versus case temperature.

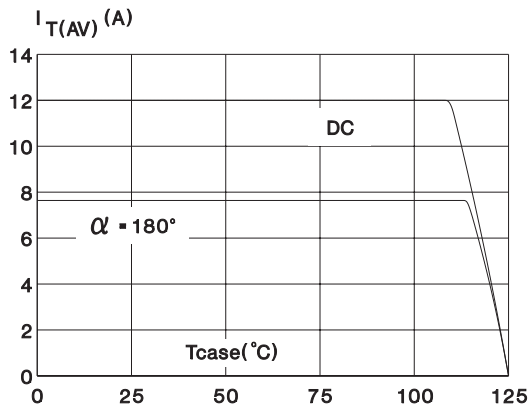

Fig. 4: Relative variation of thermal impedance versus pulse duration.

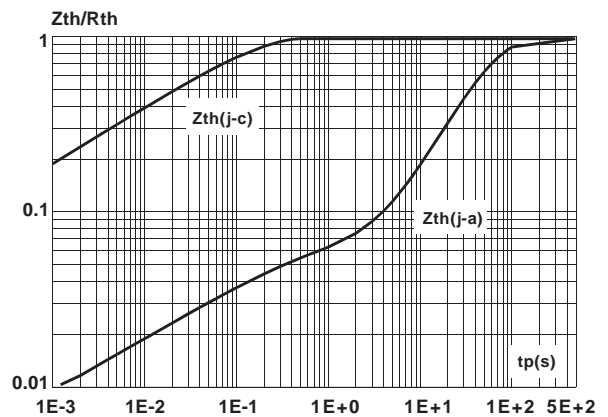

Fig. 5: Relative variation of gate trigger current versus junction temperature.

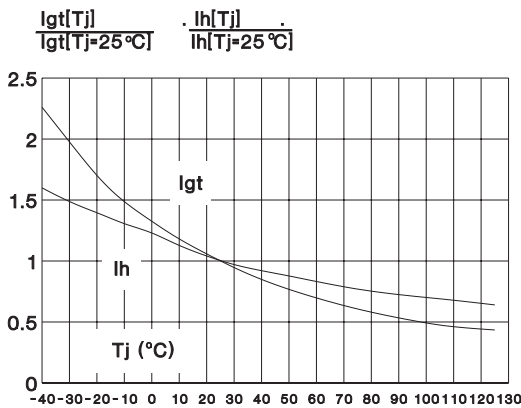

Fig. 6: Non repetitive surge peak on-state current versus number of cycles.

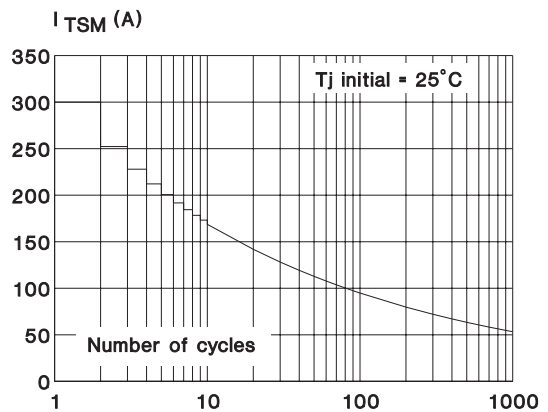

Fig. 7: Non repetitive surge peak on-state current for a sinusoidal pulse with width: $t \leq 10\text{ms}$, and corresponding value of I^2t .

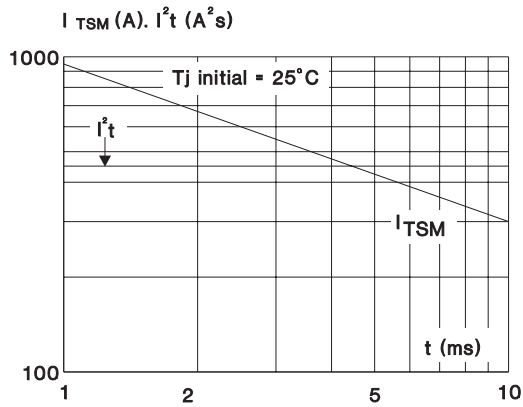

Fig. 8: On-state characteristics (maximum values).

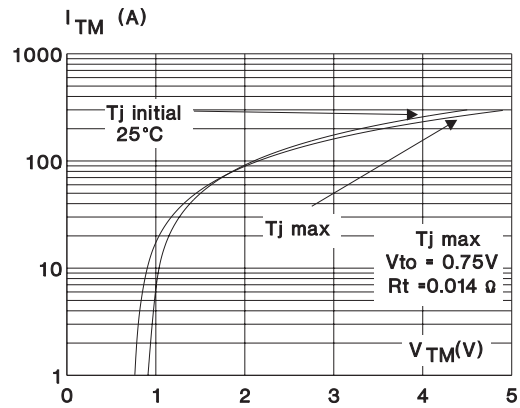

Fig. 9: Peak capacitor discharge current versus pulse width.

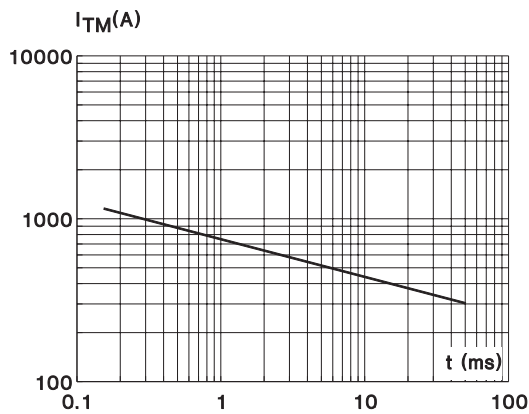
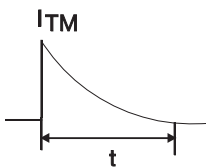
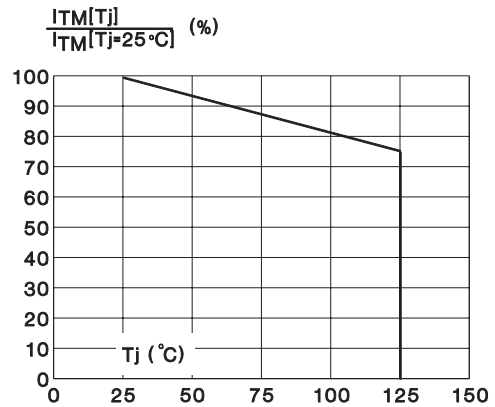
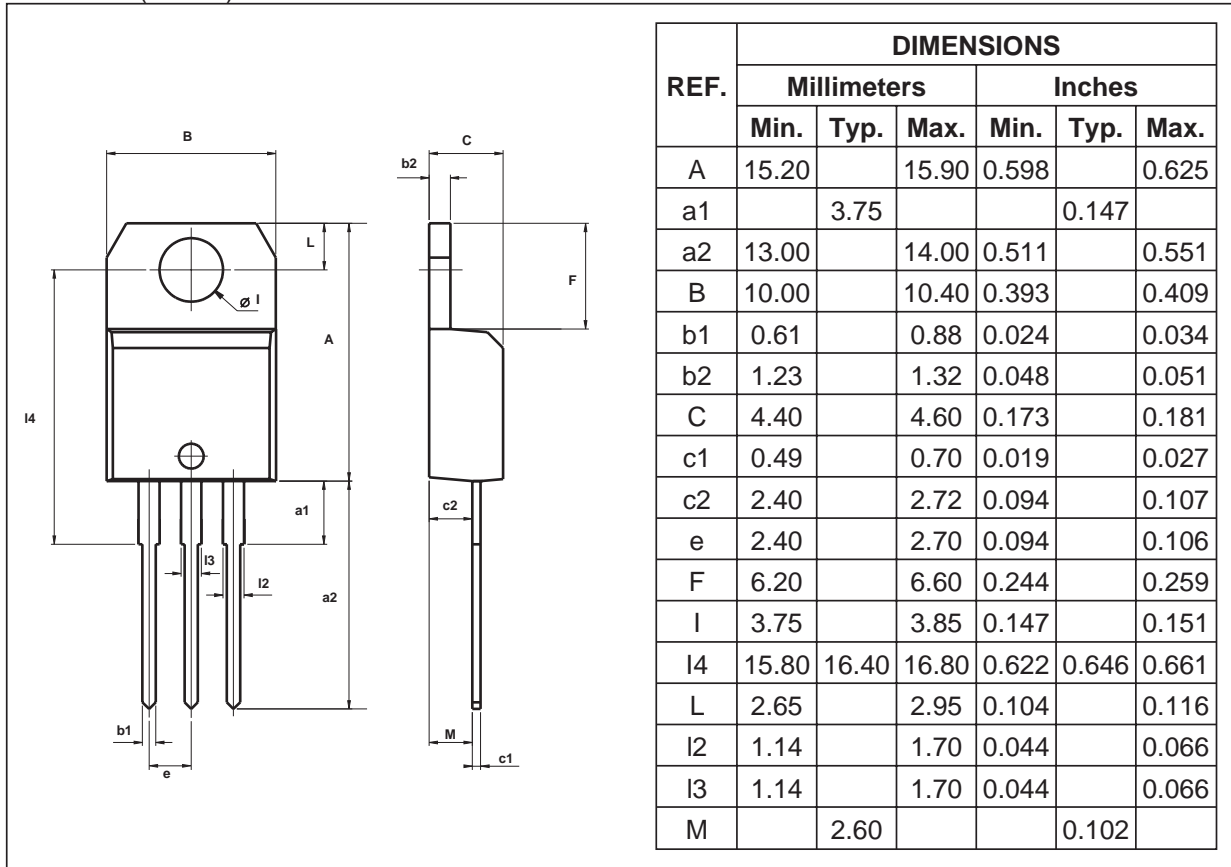

Fig. 10: Allowable peak capacitor discharge current versus initial junction temperature.



PACKAGE MECHANICAL DATA
TO-220AB (Plastic)



OTHER INFORMATION

Ordering type	Marking	Package	Weight	Base qty	Delivery mode
TYPx12	TYPx12	TO-220AB	2.3 g	250	Bulk

- Epoxy meets UL94,V0
- Cooling method: C
- Recommended torque value: 0.8 m.N.
- Maximum torque value: 1 m.N.

Information furnished is believed to be accurate and reliable. However, STMicroelectronics assumes no responsibility for the consequences of use of such information nor for any infringement of patents or other rights of third parties which may result from its use. No license is granted by implication or otherwise under any patent or patent rights of STMicroelectronics. Specifications mentioned in this publication are subject to change without notice. This publication supersedes and replaces all information previously supplied. STMicroelectronics products are not authorized for use as critical components in life support devices or systems without express written approval of STMicroelectronics.

The ST logo is a registered trademark of STMicroelectronics
© 2001 STMicroelectronics - Printed in Italy - All rights reserved.

STMicroelectronics GROUP OF COMPANIES
Australia - Brazil - China - Finland - France - Germany - Hong Kong - India - Italy - Japan - Malaysia
Malta - Morocco - Singapore - Spain - Sweden - Switzerland - United Kingdom - U.S.A.

<http://www.st.com>

