

Agilent U2000 Series USB Power Sensors

Data Sheet

The compact, low-cost alternative to conventional power measurement solutions



Anticipate —Accelerate —Achieve



Agilent Technologies

Why Agilent's Power Meters and Sensors?



Reliable, high-performing solutions

Every power meter and sensor from Agilent consistently delivers great results.



A sure investment for many years to come

Code-compatibility between power meters reduces the need for re-coding. Not only that, all Agilent power meters are backward-compatible with most legacy power sensors.



One specific application: One right solution

Agilent offers a wide selection of power meters and sensors for practically all application needs—wireless communications, radar pulse measurements, component test, and more.



Global network support

No matter where you are, Agilent is committed to giving you the 24-hour support you need regarding our products, applications, or services.

Agilent's power meters have long been recognized as the industry standard for RF and microwave power measurements.

Compact Solutions for Testing Today's RF and Microwave Communication Systems

For installation and maintenance of base stations



- Lightweight and rugged
- Simple set-up and usage
- Portable with low power consumption
- Wide dynamic and frequency ranges
- Quick and easy testing with large display of readings
- Internal trigger eliminates the problem for applications that do not have external trigger signal
- Trace display capability enables easy gate setup

For production testing of wireless components



- Compact build saves rack space
- Simple set-up and usage
- Wide dynamic and frequency ranges
- Fast reading speed
- Internal zeroing reduces test time and sensor wear-and-tear
- Quick and easy multiple channels testing with simultaneous display of readings, limits and alerts
- Seamless integration to system with industry-standard SCPI
- Internal trigger eliminates the problem for tests that do not have external trigger signal
- Trace display capability enables easy trigger level and gate setup

For R&D of wireless components



- Compact build saves bench space
- Simple set-up and usage
- Wide dynamic and frequency ranges
- High accuracy
- Advanced troubleshooting of designs with simultaneous display of multiple readings, measurement math and data recording
- Internal trigger eliminates the problem for applications that do not have external trigger signal

Introducing the U2000 Series USB Power Sensors

The U2000 Series enable simpler, lower-cost power measurements versus conventional power meter and sensor combinations. Now with nine high-performance models, the U2000 Series USB power sensors offer compact, high-performance solutions for today's CW and modulated signals.

Key features

- Compact, lightweight solutions
- Quick, simple set-up
- High accuracy, high power
- Internal zeroing capability
- Fast reading speed
- Wide frequency range: 9 kHz to 26.5 GHz (sensor option dependant)
- Wide dynamic range: -60 to +44 dBm
- Support internal and external trigger measurements*
- Trace display capability enables easy trigger level and gate setup for burst signals
- Allows remote measurements beyond cable length
- Enables monitoring of more than 20 channels simultaneously
- Converts select Agilent instruments to power meters
- Feature-packed software provides various capabilities for easy testing and analysis
- Average power measurements of CW and modulated signals, including GSM, EDGE, WLAN and WiMAX™

* Except U2004A model



Compact “power meters”, simple set-up

The U2000 Series are standalone sensors. That means they essentially operate like power meters, just in smaller forms. No reference calibrator is required. The fact that each sensor draws minimal power from a USB port—and that it doesn't need additional triggering modules or power adaptors to operate—makes it more portable, especially for base station testing. Setting up is easy: just plug it to the USB port of your PC or laptop—or even select network or handheld spectrum analyzer—and start your power measurements. The figure below illustrates the very simple, straightforward setup of the U2000 Series.

High accuracy

Each U2000 Series sensor provides excellent linearity, SWR and uncertainty specifications, so you can be confident in every measurement you make.

Wide range, high power

The U2000 Series' dynamic range spans across a wide 80 dB, taking on high power up to +44 dBm.

Remote monitoring and tests

With the U2000 Series sensor plugged to a networked USB hub, you can conveniently monitor power measurements of an antenna tower from the control room, beyond the limits of USB cable lengths.

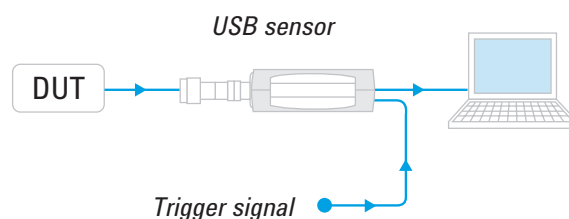

Introducing the U2000 Series USB Power Sensors (continued)

Faster production testing of multiple channels

The U2000 Series' fast measurement speed helps reduce test time. This, coupled with the capability to enable monitoring of more than 20 channels simultaneously, is an advantage in the production line where efficiency is of utmost priority.

The U2000 Series has both internal and external zeroing capabilities. With internal zeroing, high isolation switches in the sensor are opened to isolate the sensor from the device-under-test (DUT) it is connected to. As such, you don't need to power-off the DUT or disconnect the sensors. This speeds up testing and reduces sensor wear-and-tear.

No manual input of calibration data is required. All calibration factors, as well as temperature and linearity corrections, are stored in the sensors' EEPROM, auto-downloaded at calibration.

Often times, you'd need to automate your tests. The U2000 Series sensors are well-equipped for seamless integration to your system with industry-standard SCPI compatibility. They also come with built-in triggering capability to allow receipt of external triggers from other instruments.

Transform your signal generators and spectrum analyzers into accurate power meters

You could literally have a power meter next to you—or instead, turn your Agilent MXG signal generator or N9340A/B handheld spectrum analyzer into a power meter for accurate power measurements. Even with the U2000 connected, you can switch between power measurements and the device's original function at any time. You can also use the U2000 with your Agilent PNA network analyzer for source power calibration.



Intuitive power analysis software

The N1918A Power Analysis Manager software not only displays measurements with the U2000 Series, it also provides various features and functions to help you monitor and troubleshoot signals efficiently and effectively.

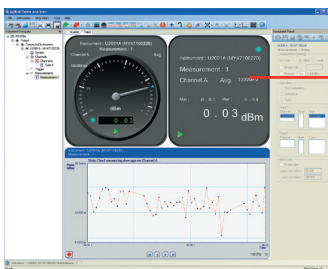

Multiple display types¹

Multiple channel list and measurement math

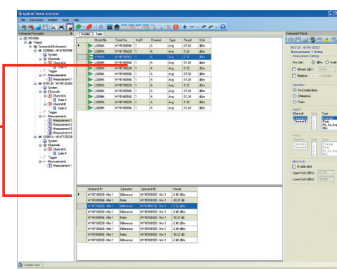

Data recording with limit and alert settings¹

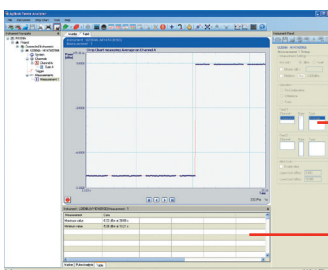

Min/Max readings

1. Software capability differs between the two versions of the software: Power Panel and Power Analyzer. Please refer to page 18 for detailed comparison.

Take a Closer Look

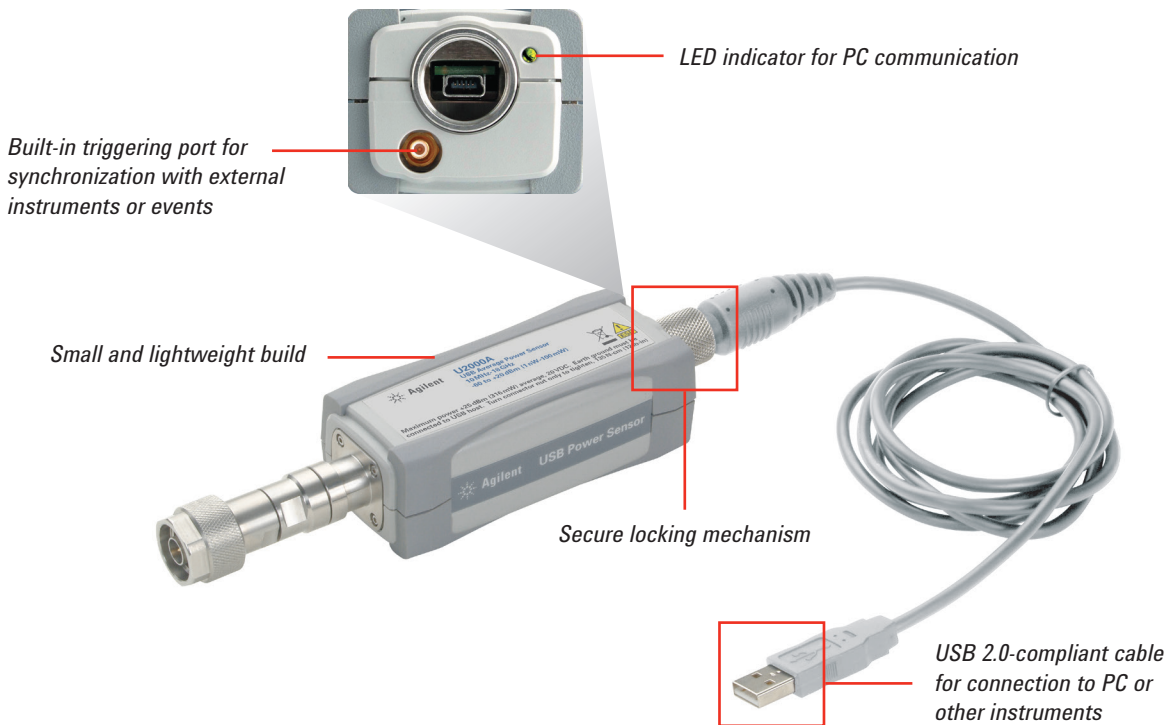

Diode-based sensors frequently rely on the application of correction factors to extend their dynamic range beyond their square-law region, typically in the range of -70 to -20 dBm. While this technique achieves measurement of CW signals over a wide dynamic range, it fails to do so for modulated signals when the signal level is above the square-law region. Modulated signals must be padded down, with their average and peak power levels within the diode square-law region, for accurate average power measurement.

The U2000 Series USB power sensors are true-average, wide-dynamic-range RF/microwave power sensors, based on a dual-sensor diode pair/attenuator/diode pair topology as proposed by Szente et. al. in 1990¹.

The simplified block diagram shown here illustrates this technique.

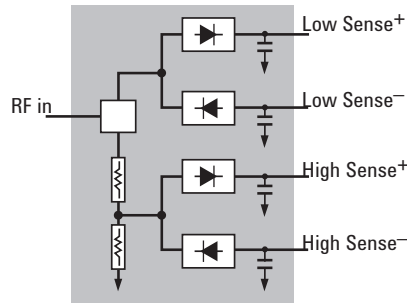

This technique ensures diodes in the selected signal path are kept in their square law region—with output current and voltage proportional to input power. The diode pair/attenuator/

diode pair assembly can then yield the average of complex modulation formats across a wide dynamic range, irrespective of signal bandwidth.

The dual-range Modified Barrier Integrated Diode (MBID)² package incorporates diode stacks in place of single diodes. This further improves measurement accuracy of high-level signals with high crest factors without incurring damage³ to the sensor.

Implementation of both techniques in the U2000 Series USB sensors enable effective average power measurements of a wide range of signals, including multitone and spread spectrum signals used in CDMA, W-CDMA and digital television systems.

1. US Patent #4943764, assigned to Hewlett-Packard Company
 2. November 1986 Hewlett-Packard Journal pages 14-2, "Diode Integrated Circuits for Millimeter-Wave Applications"
 3. Refer to "Maximum Power" on page 9 for maximum power handling specifications

Specifications

Specifications contained in this chapter are valid ONLY after proper calibration of the power sensor and apply to continuous wave (CW) signals unless otherwise stated. The recommended calibration interval for this product is one year. Specifications apply over a temperature range 0 to +55 °C unless otherwise stated. Specifications quoted over a temperature range of 25 °C ± 10 °C apply to a relative humidity of 15% to 75% and conform to the standard environmental test conditions. Specifications are valid after a 30-minute warm-up period.

Supplemental characteristics, shown in italics, are intended to provide useful information with regard to applying the power sensors in that they contain typical, but non-warranted performance parameters. These characteristics are shown in italics or denoted as “*typical*”, “*nominal*” or “*approximate*”.

Measurement speed

Normal: 20 readings/s

x2: 40 readings/s

Fast: 110 readings/s

Buffered (50 readings):

1000 readings/s¹

The U2000 Series USB sensors have two measurement modes:

Average only mode (default mode): optimized for wide dynamic range. In this measurement mode, a trigger can be controlled externally via TTL input.

Normal² mode: used for making average power measurement in a defined time interval (time-gated measurement) with reduced dynamic range. A trigger can be derived from an RF signal (internal trigger) or controlled externally via TTL input (external trigger).

1. The 1000 reading/s is the derived measurement speed from the first 50 readings in buffered mode. The maximum number of measurements that can be obtained in one second is 250 readings in buffered mode.

2. Not applicable for U2004A.

Frequency and power ranges

Model	Frequency range	Power range	Maximum power
U2000A	10 MHz to 18 GHz	-60 to +20 dBm	+25 dBm avg, 20 VDC +33 dBm pk, < 10 μs
U2001A	10 MHz to 6 GHz		
U2002A	50 MHz to 24 GHz		
U2004A	9 kHz to 6 GHz	-60 to +20 dBm	+25 dBm avg, 5 VDC +33 dBm pk, < 10 μs
U2000B	10 MHz to 18 GHz	-30 to +44 dBm	+45 dBm avg, 20 VDC +47 dBm pk, 1 μs
U2001B	10 MHz to 6 GHz		
U2000H	10 MHz to 18 GHz	-50 to +30 dBm	+33 dBm avg, 20 VDC +50 dBm pk, 1 μs
U2001H	10 MHz to 6 GHz		
U2002H	50 MHz to 24 GHz	-50 to +30 dBm	+33 dBm avg, 10 VDC +50 dBm pk, 1 μs

Maximum SWR

Model	Frequency range	Maximum SWR (25 °C ± 10 °C)	Maximum SWR (0 °C to 55 °C)
U2000A	10 to 30 MHz	1.15	1.21
	30 MHz to 2 GHz	1.13	1.15
	2 to 14 GHz	1.19	1.20
	14 to 16 GHz	1.22	1.23
	16 to 18 GHz	1.26	1.27
U2001A	10 to 30 MHz	1.15	1.21
	30 MHz to 2 GHz	1.13	1.15
	2 to 6 GHz	1.19	1.20
U2002A	50 MHz to 2 GHz	1.13	1.15
	2 to 14 GHz	1.19	1.20
	14 to 16 GHz	1.22	1.23
	16 to 18 GHz	1.26	1.27
	18 to 24 GHz	1.30	1.30
U2004A	9 kHz to 2 GHz	1.13	1.15
	2 to 6 GHz	1.19	1.20
U2000B	10 MHz to 2 GHz	1.12	1.14
	2 to 12.4 GHz	1.17	1.18
	12.4 to 18 GHz	1.24	1.25
U2001B	10 MHz to 2 GHz	1.12	1.14
	2 to 6 GHz	1.17	1.18
U2000H	10 MHz to 8 GHz	1.15	1.17
	8 to 12.4 GHz	1.25	1.26
	12.4 to 18 GHz	1.28	1.29
U2001H	10 MHz to 6 GHz	1.15	1.17
U2002H	50 MHz to 8 GHz	1.15	1.17
	8 to 12.4 GHz	1.25	1.26
	12.4 to 18 GHz	1.28	1.29
	18 to 24 GHz	1.30	1.31

Specifications (continued)

Typical SWR for U2000A sensor
(25 °C ± 10 °C)

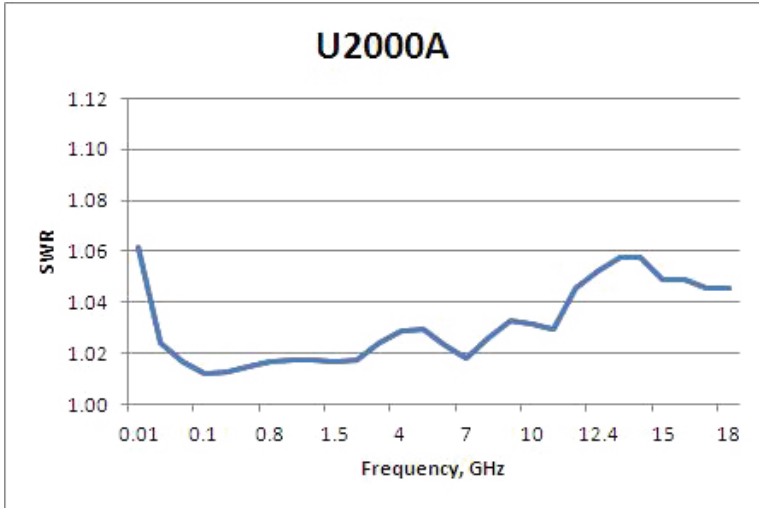

Typical SWR for U2001A sensor
(25 °C ± 10 °C)

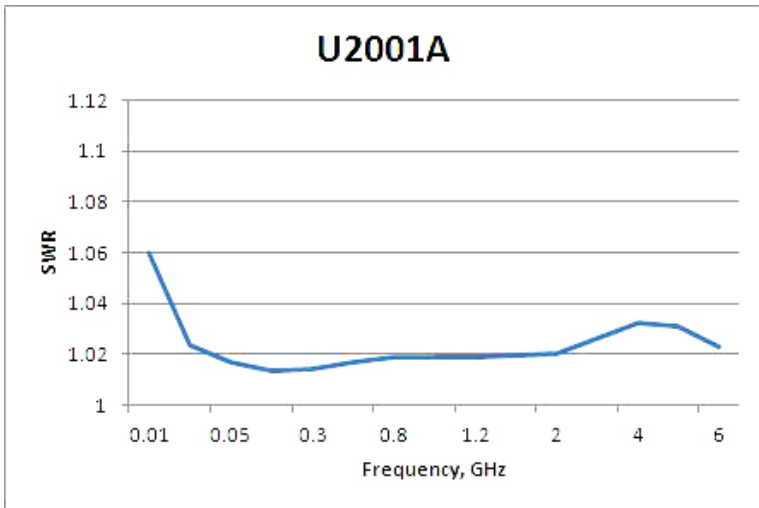

Typical SWR for U2002A sensor
(25 °C ± 10 °C)

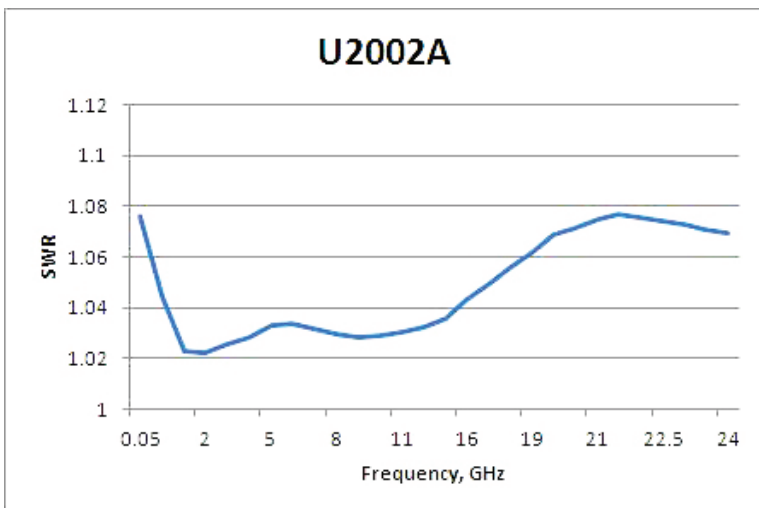

Specifications (continued)

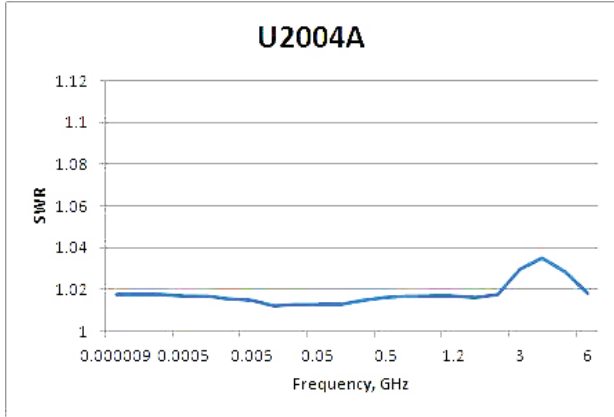

Typical SWR for U2004A sensor (25 °C ± 10 °C)

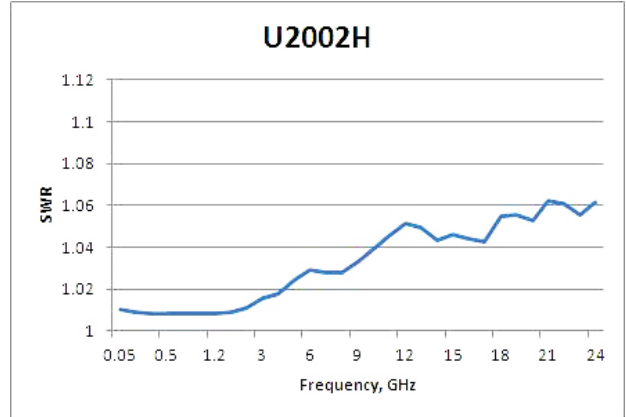

Typical SWR for U2002H sensor (25 °C ± 10 °C)

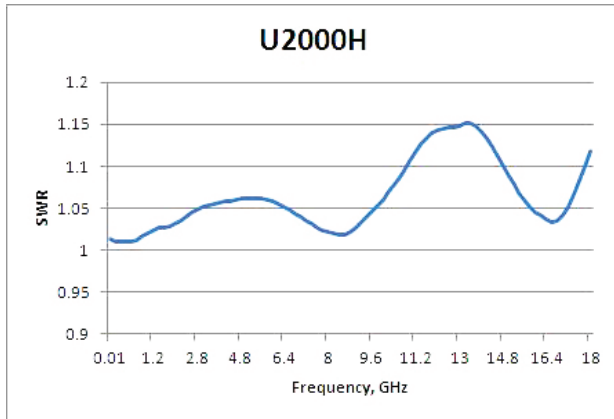

Typical SWR for U2000H sensor (25 °C ± 10 °C)

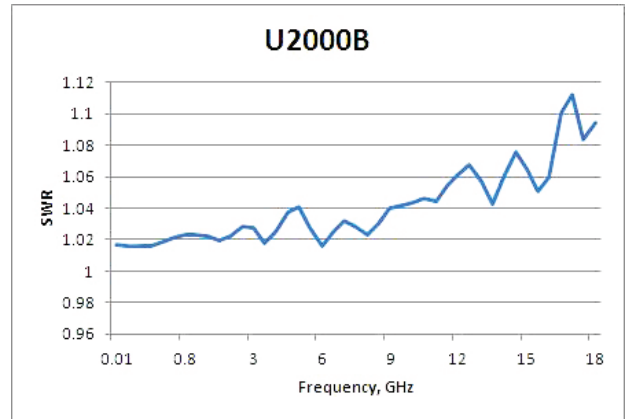

Typical SWR for U2000B sensor (25 °C ± 10 °C)

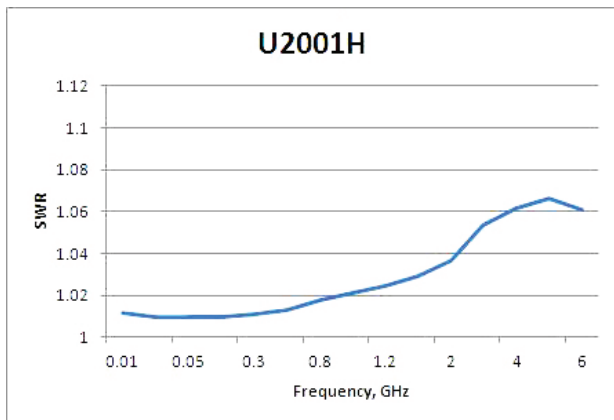

Typical SWR for U2001H sensor (25 °C ± 10 °C)

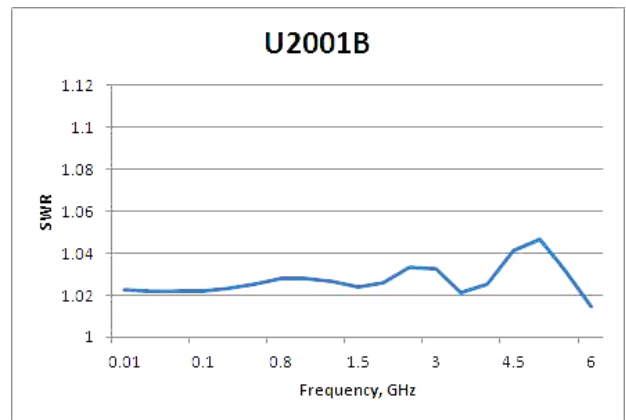

Typical SWR for U2001B sensor (25 °C ± 10 °C)

Specifications (continued)

Switching point

The U2000 Series power sensors have two measurement paths: a low power path and a high power path, as shown in the table below.

Models	AUTO (default) range	Low power path	High power path	Switching point
U2000/1/2/4A	–60 to +20 dBm	–60 to –7 dBm	–7 to +20 dBm	–7 dBm
U2000/1/2H	–50 to +30 dBm	–50 to +3 dBm	+3 to +30 dBm	+3 dBm
U2000/1B	–30 to +44 dBm	–30 to +23 dBm	+23 to +44 dBm	+23 dBm

Each power sensor automatically selects the proper power level path. To avoid unnecessary switching when the power level is close to the switching point, switching point hysteresis has been added.

Offset at switching point:
 $\leq \pm 0.5\%$ ($\leq \pm 0.02$ dB) typical

Switching point hysteresis:
 ± 0.5 dBm typical

Example with U2000 “A” suffix sensors: Switching point for the U2000/1/2/4A sensors is at –7 dBm. Hysteresis causes the low power path to remain selected until approximately –6.5 dBm as the power level is increased. Above this power, the high power path is selected. The high power path remains selected until approximately –7.5 dBm is reached as the signal level decreases. Below this power, the low power path is selected.

Power accuracy

Average only Mode Power Accuracy¹ (with exclusions)

Model	Power range	Accuracy ¹ (25 °C \pm 10 °C)	Accuracy ¹ (0 °C to 55 °C)
U2000/1/2/4A	–60 to +20 dBm	$\pm 3.0\%$	$\pm 3.5\%$
U2000/1/2H	–50 to +30 dBm	$\pm 4.0\%$	$\pm 5.0\%$
U2000/1B	–30 to +44 dBm	$\pm 3.5\%$	$\pm 4.0\%$

Specifications valid with the following conditions:

- After zeroing³
- Number of averages = 1024
- After 30 minutes of power-on warm-up

Normal Mode Power Accuracy^{1,2} (with exclusions)

Model	Power level	Accuracy (25 °C \pm 10 °C)
U2000/1/2/A	–30 to +20 dBm	$\pm 4.0\%$
U2000/1/2H	–20 to +30 dBm	$\pm 5.0\%$
U2000/1B	0 to +44 dBm	$\pm 4.5\%$

1. This accuracy is essentially a combination of linearity, instrumentation accuracy, and traceability to absolute accuracy at 50 MHz, 0 dBm.
 Note: Mismatch uncertainty, calibration factor uncertainty, and power level dependent terms (zero set, drift, and noise) are excluded in this specification and specified elsewhere in the data sheet.
2. The accuracy for –7 to +1 dBm (U2000/1/2A), +3 to +11 dBm (U2000/1/2H), and +23 to +31 dBm (U2000/1B) power level will be dominated by zero set and measurement noise. For overall accuracy, refer to the measurement uncertainty calculator which is available on the Agilent Technologies Web site.
3. It is advisable to perform external zeroing on the U2000 Series power sensor for power measurement level below –30 dBm. During the external zeroing process, the RF input signal must be switched off or the device-under-test disconnected from the U2000 Series power sensor.

Specifications (continued)

Typical power accuracy at 25 °C for U2000/1/2/4A sensors^{1, 2}

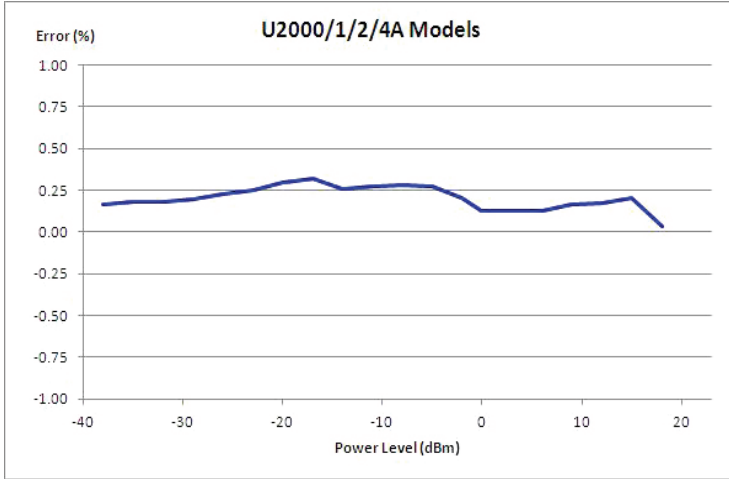

Typical power accuracy at 25 °C for U2000/1B sensors^{1, 2}

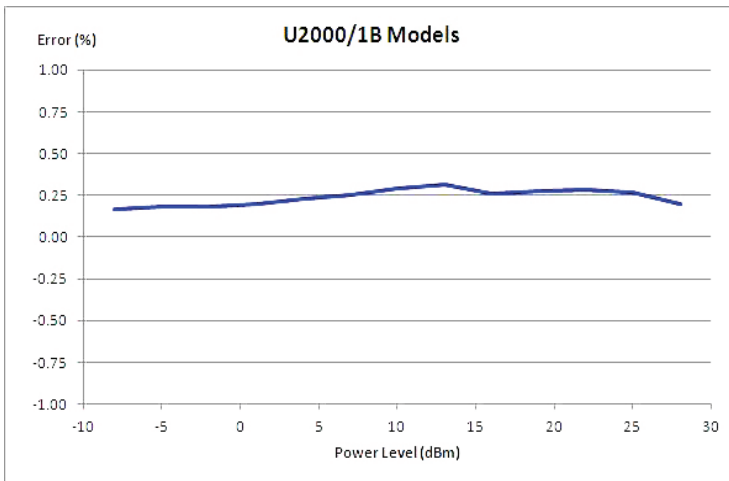

Typical power accuracy at 25 °C for U2000/1/2H sensors^{1, 2}

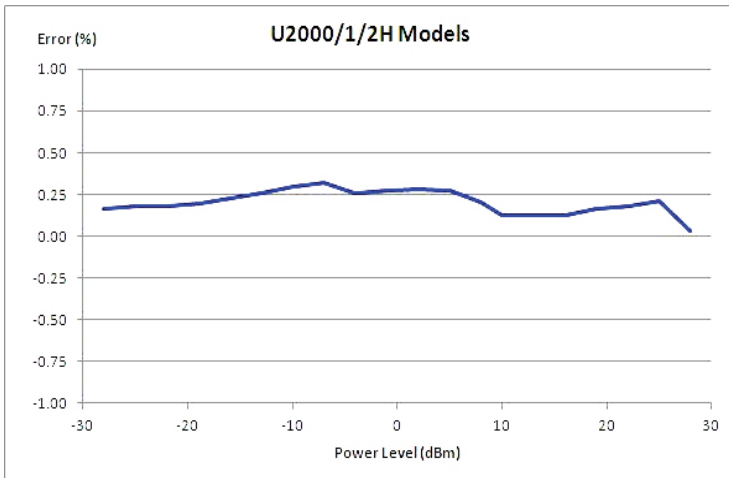

1. Measurement uncertainty $\leq 1.9\%$. At room temperature and excluding power level dependent terms (zero set, drift, and noise). Refer to Agilent Fundamentals of RF and Microwave Power Measurements (Part 3) Power Measurement Uncertainty per International Guide (Application Note 1449-3), 5988-9215EN for more information on measurement uncertainty.

2. After zeroing, 30 minutes of power-on warm-up, and 1024 averages.

Specifications (continued)

Zero set, zero drift, and measurement noise

Average only Mode

Power range ¹	Zero set (internal)	Zero set (external)	Zero drift ²	Measurement noise ³
U2000/1/2/4A				
-60 to -35 dBm	± 1.5 nW	± 600 pW	200 pW	1 nW
-38 to -15 dBm	± 2 nW	± 1.5 nW	400 pW	1.5 nW
-20 to -6.5 dBm	± 12 nW	± 10 nW	1.5 nW	15 nW
-7.5 to -2 dBm	± 2 µW	± 500 nW	50 nW	650 nW
-4 to 15 dBm	± 4 µW	± 1 µW	500 nW	1 µW
10 to 20 dBm	± 6 µW	± 5 µW	2 µW	10 µW
U2004A				
-60 to -35 dBm	± 2.8 nW	± 600 nW	200 nW	1 nW
-38 to -15 dBm	± 3 nW	± 1.5 nW	400 nW	1.5 nW
-20 to -6.5 dBm	± 12 nW	± 10 nW	1.5 nW	15 nW
-7.5 to -2 dBm	± 2 µW	± 500 µW	50 nW	650 µW
-4 to 15 dBm	± 4 µW	± 1 µW	500 µW	1 µW
10 to 20 dBm	± 6 µW	± 5 µW	2 µW	10 µW
U2000/1/2H				
-50 to -25 dBm	± 15 nW	± 8 nW	2 nW	10 nW
-28 to -5 dBm	± 20 nW	± 20 nW	4 nW	15 nW
-10 to 3.5 dBm	± 120 nW	± 100 nW	15 nW	150 nW
2.5 to 8 dBm	± 20 µW	± 20 µW	500 nW	6.5 µW
6 to 25 dBm	± 40 µW	± 30 µW	5 µW	10 µW
20 to 30 dBm	± 60 µW	± 60 µW	20 µW	100 µW
U2000/1B sensors				
-30 to -5 dBm	± 1.8 µW	± 800 nW	200 nW	1 µW
-8 to 15 dBm	± 2 µW	± 2 µW	400 nW	1.5 µW
10 to 23.5 dBm	± 12 µW	± 10 µW	1.5 µW	15 µW
22.5 to 28 dBm	± 2 mW	± 1 mW	50 nW	650 µW
26 to 44 dBm	± 4 mW	± 2 mW	500 µW	1 mW

1. Condition: (i) 0 to 55 °C and (ii) 95% relative humidity at 40 °C non-condensing.

2. Within one hour after zero set, at a constant temperature, after a 24-hour warm-up of the power sensor.

3. The number of averages at 1 for **Normal** speed, gate length of 2.27 ms, measured over one minute interval and two standard deviations.

Normal Mode

Range ¹	Zero set (internal)	Zero set (external)	Zero drift ²	Measurement noise ³	Noise per sample ⁴
U2000/1/2A					
-38 to -15 dBm	47 nW	43 nW	25 nW	28 nW	90 nW
-20 to -6.5 dBm	530 nW	480 nW	230 nW	300 nW	1 μW
-7.5 to -2 dBm	30 μW	27 μW	19 μW	20 μW	55 μW
-4 to 15 dBm	32 μW	30 μW	24 μW	21 μW	85 μW
10 to 20 dBm	270 μW	200 μW	110 μW	180 μW	550 μW
U2000/1/2H					
-28 to -5 dBm	730 nW	500 nW	300 nW	310 nW	900 nW
-10 to 3.5 dBm	5.3 μW	4.8 μW	3 μW	5 μW	10 μW
-2.5 to 8 dBm	330 μW	270 μW	190 μW	230 μW	550 μW
8 to 25 dBm	440 μW	300 μW	300 μW	260 μW	850 μW
20 to 30 dBm	3.9 μW	2.8 mW	1.1 mW	2.8 mW	5.5 mW
U2000/1B					
-8 to 15 dBm	47 nW	43 μW	25 μW	28 μW	90 μW
10 to 23.5 dBm	530 nW	480 μW	230 μW	300 μW	1 mW
22.5 to 28 dBm	30 μW	27 mW	19 mW	20 mW	55 mW
26 to 44 dBm	32 μW	34 mW	24 mW	21 mW	85 mW

1. Condition: (i) 0 to 55 °C and (ii) 95% relative humidity at 40 °C non-condensing.

2. Within one hour after zero set, at a constant temperature, after a 24-hour warm-up of the power sensor.

3. The number of averages at 1 for **Normal** speed, gate length of 2.27 ms, measured over one minute interval and two standard deviations.

4. The Noise Per Sample specification is only applicable for gated power working range stated in the "Normal Mode Key Specifications and Characteristics" table.

Specifications (continued)

Effect of time-gating and averaging on normal mode measurement noise:

The normal mode measurement noise will depend on the gate length (time-gated period in second) and the number of averages. The noise can be approximately calculated with the following equations.

If the gate length is $< 2.73 \mu\text{s}$, use Equation 1:

$$\text{Noise} = \text{Noise per sample} \times \frac{1}{\sqrt{\text{Number of averages}}}$$

Otherwise, use Equation 2:

$$\text{Noise} = \text{Noise per sample} \times \frac{1}{\sqrt{\text{Number of averages}}} \times \left(\frac{4}{\text{Gate length}/(0.68 \mu\text{s})} \right)^{1/4}$$

Note: If the noise value obtained from Equation 1 or 2 is lower than the measurement noise specification, use the value as specified in the measurement noise table.

Effects of averaging on noise:

Averaging over 1 to 1024 readings is available for reducing noise. The table below provides the measurement noise for a particular sensor with the number of averages set at 16 (for normal mode) and 32 (for x2 mode). Use the noise multiplier, for the appropriate of averages, to determine the total measurement noise value.

Example:

U2000A power sensor, -60 to -35 dBm, normal mode, number of averages = 4

Measurement noise calculation:

$1 \text{ nW} \times 1.7 = 1.7 \text{ nW}$

Average only Mode

Number of averages	1	2	4	8	16	32	64	128	256	512	1024
Noise multiplier											
Normal mode	2.0	1.8	1.7	1.5	1.0	0.95	0.74	0.55	0.39	0.29	0.21
x2 mode	2.7	2.4	2.0	1.6	1.0	0.91	0.78	0.53	0.34	0.29	0.20

Specifications (continued)

Settling time

Manual filter, 10-dB decreasing power step (not across switching points)

Number of averages	1	2	4	8	16	32	64	128	256	512	1024
Settling time (s)											
Normal speed	0.045	0.09	0.17	0.34	0.66	1.3	2.6	5.2	10.4	20.9	41.9
x2 speed	0.042	0.05	0.09	0.17	0.34	0.66	1.3	2.6	5.2	10.4	20.9

Auto filter, default resolution, 10-dB decreasing power step

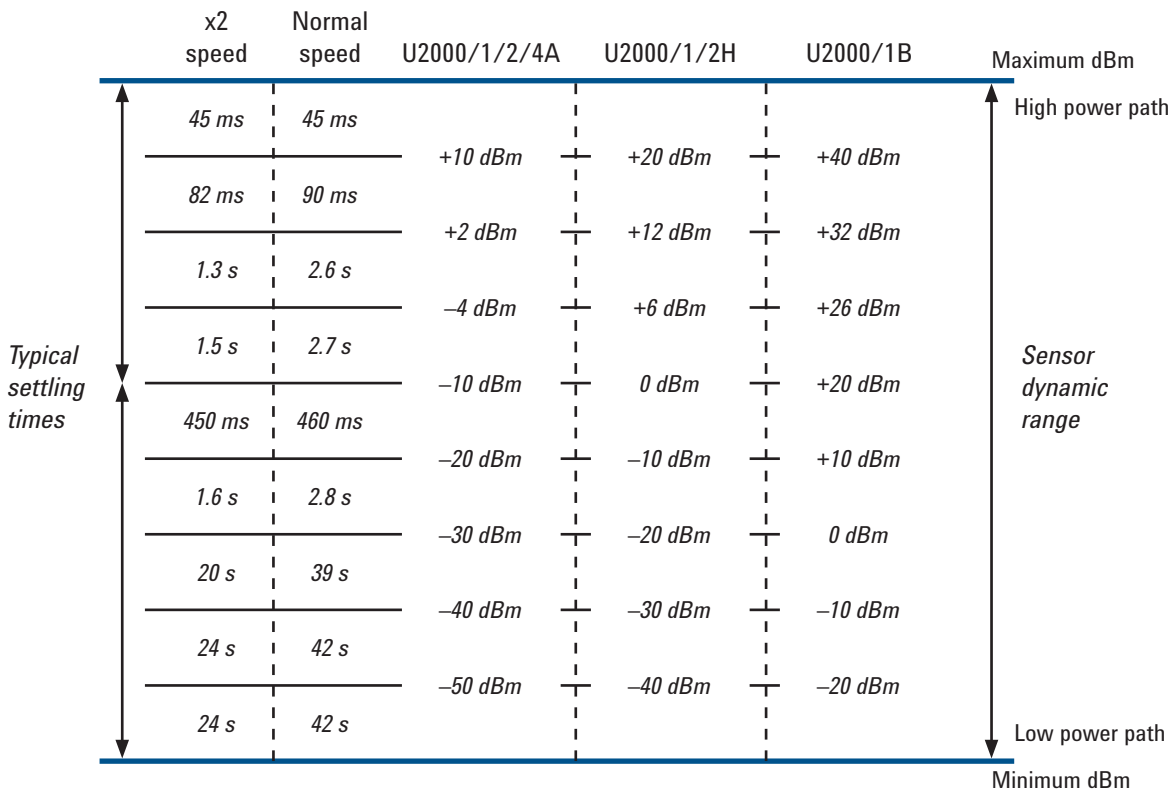

Settling time with auto filter, default resolution, and a 10 dB decreasing power step (not across the switching point)

Settling time = 25 ms*

* When a power step crosses through the sensor's auto-range switching point, add 25 ms

Specifications (continued)

Calibration factor and reflection coefficient

Calibration factor (CF) and reflection coefficient (Rho) data is unique to each sensor. The CF corrects for the frequency response of the sensor. The reflection coefficient (Rho or ρ) relates to the SWR based on the following formula:

$$SWR = \frac{1 + \rho}{1 - \rho}$$

Maximum uncertainties of the CF data are listed in the following table. There is only one set of CF data used for both high and low power paths of each sensor.

The uncertainty analysis for the calibration data was done in accordance with the ISO Guide. The uncertainty data reported on the calibration certificate is the expanded uncertainty with a 95% confidence level and a coverage factor of 2.

Frequency	Uncertainty (%) (25 °C ± 10 °C)
U2000A sensor	
10 to 30 MHz	1.8
30 MHz to 2 GHz	1.6
2 to 14 GHz	2.0
14 to 16 GHz	2.2
16 to 18 GHz	2.2
U2001A sensor	
10 to 30 MHz	1.8
30 MHz to 2 GHz	1.6
2 to 6 GHz	2.0
U2002A sensor	
50 MHz to 2 GHz	2.0
2 to 14 GHz	2.5
14 to 16 GHz	2.7
16 to 18 GHz	2.7
18 to 24 GHz	3.0
U2004A sensor	
9 kHz to 2 GHz	1.8
2 to 6 GHz	1.8
U2000B sensor	
10 MHz to 2 GHz	1.8
2 to 12.4 GHz	2.0
12.4 to 18 GHz	2.2
U2001B sensor	
10 MHz to 2 GHz	1.8
2 to 6 GHz	2.0
U2000H sensor	
10 MHz to 8 GHz	2.0
8 to 12.4 GHz	2.0
12.4 to 18 GHz	2.2
U2001H sensor	
10 MHz to 6 GHz	2.0
U2002H sensor	
50 MHz to 8 GHz	2.5
8 to 12.4 GHz	2.5
12.4 to 18 GHz	2.7
18 to 24 GHz	3.0

Specifications (continued)

Trigger

Internal trigger	
Resolution	0.1 dB
Level accuracy	± 1 dB
Jitter	± 1 µs
External TTL trigger input	
Impedance	50 Ω or 1 kΩ ¹
Trigger low	< 1.1 V
Trigger high	> 1.9 V
Minimum trigger pulse width	35 ns
Minimum trigger repetition period	80 ns
Trigger latency	11 µs ± 2 µs
Trigger delay	
Range	-0.15 to + 0.15 s
Resolution	1 µs
Trigger hold-off	
Range	1 µs to 400 ms
Resolution	1 µs
Trigger hysteresis	
Range	0 to +3 dB
Resolution	0.1 dB

Normal Mode key specifications and characteristics

Parameters ²	Performance
Maximum video bandwidth	40 kHz
Minimum rise time	40 µs
Minimum fall time	40 µs
Range settling time	150 µs
Minimum pulse width	200 µs
Sampling rate	1.47 Msps
Maximum capture length	150 ms
Maximum pulse repetition rate	150 kHz
Dynamic range	U2000/1/2A: -30 to +20 dBm U2000/1/2H: -10 to +30 dBm U2000/1B: 0 to +44 dBm

1. This is only available for option U2001A-H16

2. Not applicable for U2004A

Specifications (continued)

General specifications

Physical characteristics	
Dimensions (LxWxH)	U2000/1/4A: 163.75 mm x 46.00 mm x 35.90 mm U2002A: 134.37 mm x 46.00 mm x 35.90 mm U2000/1B: 308.00 mm x 115.00 mm x 84.00 mm U2000/1H: 207.00 mm x 46.00 mm x 36.00 mm U2002H: 164.00 mm x 46.00 mm x 36.00 mm
Weight	U2000/1/4A: 0.262 kg U2002A: 0.226 kg U2000/1B: 0.762 kg U2000/1H: 0.324 kg U2002H: 0.274 kg
Operating environment	
Temperature	0 °C to 55 °C
Humidity	Up to 95% relative humidity at 40 °C (non-condensing)
Altitude	Up to 4600 m (15,000 ft)
Pollution	Degree 2
Storage and shipment	
Environment	Sensor should be stored in a clean, dry environment
Temperature	-30 °C to +70 °C
Humidity	Up to 90% relative humidity at 65 °C (non-condensing)
Altitude	Up to 4600 m (15,000 ft)
Pollution	Degree 2
Other	
Current requirement	200 mA max (approximately)
Connector	U2000/1/4A, U2000/1H, U2000/1B: N-type (m), 50 Ω U2002A, U2002H: 3.5 mm (m), 50 Ω
Cable	USB 2.0 Type A to 5-pin Mini-B
Programmability	SCPI , Agilent VEE, LabVIEW, Microsoft® Visual Basic
Safety and EMC compliance	IEC 61010-1:2001/EN 61010-1:2001 (2nd edition) IEC 61326:2002 / EN61326:1997+A1:1998+A2:2001+A3:2003 Canada: ICES-001:2004 Australia/New Zealand: AS/NZS CISPR11:2004
Calibration ¹	1 year
Warranty ¹	3 years
Compatible instruments	Agilent N9340A/B handheld spectrum analyzers Agilent MXG signal generators Agilent PNA, PNA-L and PNA-X Series performance network analyzers

1. See "Ordering information" for available options

Using the U2000 Series with the N1918A Power Analysis Manager

The N1918A software is available in two versions: the basic Power Panel and advanced Power Analyzer. Power Analyzer provides full access to the software's complete features and capabilities and its licenses,

N1918A-100 (PC license) and N1918A-200 (USB dongle license), are available for purchase separately. A free, fully functional trial version of the Power Analyzer automatically runs for 30 days upon installation

from the bundled N1918A Power Analysis Manager CD. The table here shows functions accessible with each version when used with the U2000 Series.

	Power panel (basic)	Power analyzer (advanced)
Measurement displays		
Compact mode display	√	√
Soft panel (digital) display	√	√ (enhanced with limits and alerts notification)
Gauge (analog) display	√	√ (enhanced with limits and alerts notification)
Strip chart display	√	√
Trace graph display	√	√
Multiple tabs	X	√
Multiple display per tab	√	√
Multilist	√	√
Graph functions		
Single marker	√ (up to 2 markers per graph)	√ (up to 10 markers per graph)
Dual marker	√ (one set of markers per graph ¹)	√ (up to 5 sets of markers per graph)
Graph autoscaling	√	√
Graph zooming	√	√
Measurement math	√ (delta, ratio)	√ (delta, ratio)

(continued)

1. Applies to usage with P-Series power meters

Using the U2000 Series with the N1918A Power Analysis Manager (continued)

(continued)

	Power panel (basic)	Power analyzer (advanced)
Save/Load file functions		
Save measurement data (with timestamp)	√ (applies to strip chart display; up to 10,000 data points)	√ (applicable in Strip Chart and Trace Graph)
Load measurement data	√ (applicable in Strip Chart and Trace Graph)	√ (applicable in Strip Chart and Trace Graph)
Data recording ² (with timestamp)	X	√ (applicable in Trace Graph ² , Soft Panel, Strip Chart, and Gauge)
Instrument settings options		
Save and restore instrument setting	√	√
Time-gated measurements	√	√
Instrument preset settings	√	√
FDO table parameters	√	√
Measurement limit and alert functions		
Limit and alert notification	X	√
Alert summary	X	√
Support function		
Print application screen	√	√

2. Recording time for trace graphs may vary based on trace graph settings

Display units:

Absolute: Watts or dBm

Relative: Percent or dB

Display resolution:

Resolution of 1.0, 0.1, 0.01 and 0.001 dB in log mode; one to four digits in linear mode

Default resolution:

0.01 dB in log mode; three digits in linear mode

Zero:

For performing internal and external zeroing

Range:

Sensor-dependent, configurable in 1-kHz steps

Relative:

Displays all successive measurements relative to the last referenced value

Offset:

Allows power measurements to be offset by -100 dB to +100 dB, configurable in 0.001 dB increments, to compensate for external loss or gain

Duty cycle:

Duty cycle values between 0.001% to 99.999% can be entered in increments of 0.01% to display a pulse power representation of measured power. The following equation is used to calculate the displayed pulse power value: $\text{Pulse Power} = \text{Measured Power} / \text{Duty Cycle}$

Limits:

High and low limits can be set in the range between -150.00 dBm to +230.000 dBm, in 0.001 dBm increments

Preset default values:

Channel Offset (dB) = 0, Duty Cycle Off, Frequency 50 MHz, AUTO Average, AUTO Range, Free Run Mode, dBm mode

Using the U2000 Series with the N1918A Power Analysis Manager (continued)

System requirements

Hardware	
Processor	Desktop PC: 1.3 GHz Pentium® IV or higher recommended Laptop PC: 900 MHz Pentium M or higher recommended
RAM	512 MB (1.0 GB or higher recommended)
Hard disk space	1.0 GB or more free disk space at runtime
Resolution	800 x 600 or higher (1280 x 1024 recommended)
Operating system and browser	
Operating system	Windows® 7 32-bit Windows Vista 32-bit ¹ Windows XP Professional 32-bit Service Pack 2 or higher ²
Browser	Microsoft Internet Explorer 5.1 (6.0 or higher recommended)
Software	
Agilent IO Libraries Suite	Version 15.5 ³ or higher
Microsoft .NET Framework	Runtime version 2.0
Microsoft Visual C++ 2005 Runtime Libraries ⁴	Version 1.0 or higher

1. Supports USB License Key only

2. Supports both PC Licensing and USB License Key

3. Available on the Agilent Automation-Ready CD-ROM. Agilent IO Libraries Suite 15.5 is required if your PC is running on Windows Vista 32-bit operating system.

4. Bundled with N1918A Power Analysis Manager CD

Ordering Information

Power sensors

Models	Description	Power range	Connector type
U2000A	10 MHz to 18 GHz USB sensor	-60 to +20 dBm	N-type male, 50 Ω
U2000B	10 MHz to 18 GHz USB sensor	-30 to +44 dBm	N-type male, 50 Ω
U2000H	10 MHz to 18 GHz USB sensor	-50 to +30 dBm	N-type male, 50 Ω
U2001A	10 MHz to 6 GHz USB sensor	-60 to +20 dBm	N-type male, 50 Ω
U2001B	10 MHz to 6 GHz USB sensor	-30 to +44 dBm	N-type male, 50 Ω
U2001H	10 MHz to 6 GHz USB sensor	-50 to +30 dBm	N-type male, 50 Ω
U2002A	50 MHz to 24 GHz USB sensor	-60 to +20 dBm	3.5 mm male, 50 Ω
U2002H	50 MHz to 24 GHz USB sensor	-50 to +30 dBm	3.5 mm male, 50 Ω
U2004A	9 kHz to 6 GHz USB sensor	-60 to +20 dBm	N-type male, 50 Ω

Options and accessories

U2001A-H03	U2001A sensor with extended frequency range, 3 MHz to 6 GHz
U2001A-H16	With 1K ohms input trigger impedance. Higher impedance is typically required when several instruments' input trigger ports are connected in parallel for triggering purpose. Standard option has 50 ohms input trigger impedance.
U2001A-H25	U2001A sensor with extended power range, -60 dBm to +25 dBm
U2002A-H26	U2002A sensor with extended frequency range, 10 MHz to 26.5 GHz

Standard-shipped accessories

Trigger cable BNC Male to SMB female 50 Ω , 1.5 m
Power sensor cable: 1.5 m, 3.0 m, or 5.0 m
U2000 Series USB Power Sensor Documentation CD
N1918A Power Analysis Manager Assembly
Agilent Automation-Ready CD (contains Agilent IO Libraries Suite)

Warranty

3-years, return-to-Agilent warranty and service plan for the U2000 Series USB power sensors
3 months for standard-shipped accessories

Ordering Information (continued)

Accessories, calibration and documentation options

Cables	Description
U2031A	USB 2.0 Type A to 5-pin Mini-B cable with secure locking mechanism, 1.5 m (5 ft)
U2031B	USB 2.0 Type A to 5-pin Mini-B cable with secure locking mechanism, 3.0 m (10 ft)
U2031C	USB 2.0 Type A to 5-pin Mini-B cable with secure locking mechanism, 5.0 m (16.4 ft)
U2032A	BNC (m) to SMB (f) trigger cable, 1.5 m, 50 W
Travel kits	Description
U2000A-201	Transit case ¹
U2000A-202	Soft carrying case
U2000B-201	Transit case ²
U2000A-204	Soft carrying pouch
Hanging kit	Description
U2000A-203	Holster
Calibration	Description
Option 1A7	ISO 17025 calibration with test data
Option A6J	ANSI Z540 calibration with test data
Warranty	Description
Option R-51B-001-Z	Return to Agilent Warranty - 3 years
Option R-51B-001-5Z	Warranty Assurance Plan - Return to Agilent - 5 years
Documentation	Description
Option OB1	English language Operating and Service Guide
Option ABD	German language Operating and Service Guide
Option ABE	Spanish language Operating and Service Guide
Option ABF	French language Operating and Service Guide
Option ABJ	Japanese language Operating and Service Guide
Option ABZ	Italian language Operating and Service Guide
Option AB2	Simplified Chinese language Operating and Service Guide
Software	Description
N1918A-100	Power Analyzer version of N1918A Power Analysis Manager software (PC license)
N1918A-200	Power Analyzer version of N1918A Power Analysis Manager software (USB dongle license)
Complementary I/O connectivity hardware	Description
E5813A ³	Networked 5-port USB hub



U2000A/B-201 Transit case



U2000A-202 Soft carrying case



U2000A-203 Holster



U2000A-204 Soft carrying pouch

1. U2000A-201 transit case for A model only.

2. U2000B-201 transit case for B and H model

3. Refer to www.agilent.com/find/e5813a for more information on the device



myAgilent

www.agilent.com/find/myagilent

A personalized view into the information most relevant to you.



AdvancedTCA® Extensions for Instrumentation and Test (AXIe) is an open standard that extends the AdvancedTCA for general purpose and semiconductor test. Agilent is a founding member of the AXIe consortium.

www.axistandard.org



LAN eXtensions for Instruments puts the power of Ethernet and the Web inside your test systems. Agilent is a founding member of the LXI consortium.

www.lxistandard.org



PCI eXtensions for Instrumentation (PXI) modular instrumentation delivers a rugged, PC-based high-performance measurement and automation system.

www.pxisa.org



Three-Year Warranty

www.agilent.com/find/ThreeYearWarranty

Beyond product specification, changing the ownership experience. Agilent is the only test and measurement company that offers three-year warranty on all instruments, worldwide.



Agilent Assurance Plans

www.agilent.com/find/AssurancePlans

Five years of protection and no budgetary surprises to ensure your instruments are operating to specifications and you can continually rely on accurate measurements.



www.agilent.com/quality



Agilent Electronic Measurement Group
 DEKRA Certified ISO 9001:2008
 Quality Management System

Agilent Channel Partners

www.agilent.com/find/channelpartners

Get the best of both worlds: Agilent's measurement expertise and product breadth, combined with channel partner convenience.

For more information on Agilent Technologies' products, applications or services, please contact your local Agilent office. The complete list is available at:
www.agilent.com/find/contactus

Americas

Canada	(877) 894 4414
Brazil	(11) 4197 3600
Mexico	01800 5064 800
United States	(800) 829 4444

Asia Pacific

Australia	1 800 629 485
China	800 810 0189
Hong Kong	800 938 693
India	1 800 112 929
Japan	0120 (421) 345
Korea	080 769 0800
Malaysia	1 800 888 848
Singapore	1 800 375 8100
Taiwan	0800 047 866
Other AP Countries	(65) 375 8100

Europe & Middle East

Belgium	32 (0) 2 404 93 40
Denmark	45 45 80 12 15
Finland	358 (0) 10 855 2100
France	0825 010 700* *0.125 €/minute
Germany	49 (0) 7031 464 6333
Ireland	1890 924 204
Israel	972-3-9288-504/544
Italy	39 02 92 60 8484
Netherlands	31 (0) 20 547 2111
Spain	34 (91) 631 3300
Sweden	0200-88 22 55
United Kingdom	44 (0) 118 927 6201

For other unlisted countries:

www.agilent.com/find/contactus

(BP-01-15-14)

Product specifications and descriptions in this document subject to change without notice.

