



## U74AHC595B

CMOS IC

### 8-BIT SHIFT REGISTER WITH 3-STATE OUTPUT REGISTERS

#### DESCRIPTION

The UTC **74AHC595** contains an 8-bit serial-in, parallel-out shift register that feeds an 8-bit D-type storage register. The storage register has parallel 3-state outputs. Separate clocks are provided for both the shift and storage registers. The shift register has a direct overriding clear ( $\overline{\text{SRCLR}}$ ) input, serial (SER) input, and a serial output for cascading. When the output-enable ( $\overline{\text{OE}}$ ) input is high, all outputs, except  $Q_H$ , are in the high-impedance state.

Both the shift-register clock (SRCLK) and storage-register clock (RCLK) are positive-edge triggered. If both clocks are connected together the shift register always is one clock pulse ahead of the storage register.

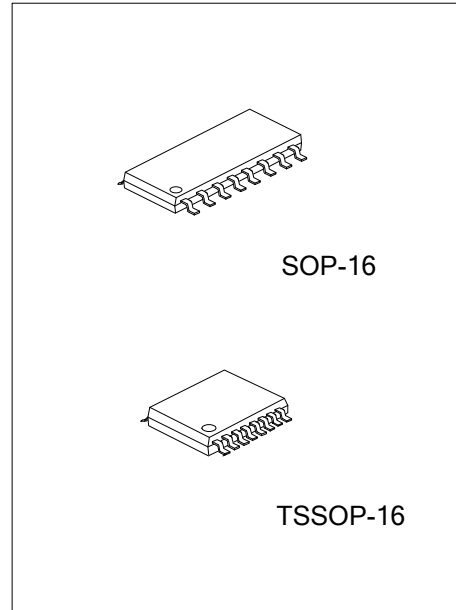

#### FEATURES

- \* Operation Voltage Range: 2 ~ 5.5V
- \* Shift Register Has Direct Clear
- \* 8-bit Serial-In, Parallel-Out Shift

#### ORDERING INFORMATION

Ordering Number		Package	Packing
Lead Free	Halogen Free		
U74AHC595BL-S16-R	U74AHC595BG-S16-R	SOP-16	Tape Reel
U74AHC595BL-P16-R	U74AHC595BG-P16-R	TSSOP-16	Tape Reel

<p>U74AHC595BG-S16-R</p>	<p>(1) R: Tape Reel (2) S16: SOP-16, P16: TSSOP-16 (3) G: Halogen Free and Lead Free, L: Lead Free</p>
--------------------------	--

#### MARKING

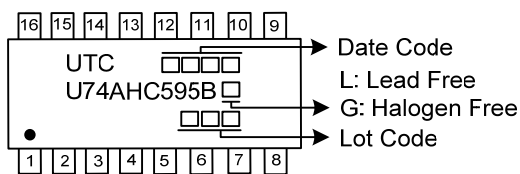

■ PIN CONFIGURATION

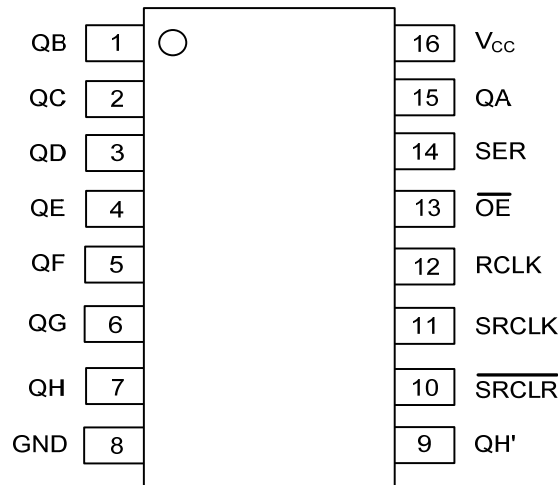

■ FUNCTION TABLE

FUNCTION	INPUTS					OUTPUTS	
	SRCLK	RCLK	$\overline{OE}$	$\overline{SRCLR}$	SER	QH'	Qn
A Low-Level on $\overline{SRCLR}$ only affects the shift registers.	X	X	L	L	X	L	NC
Empty shift register loaded into storage register.	X	↑	L	L	X	L	L
Shift register clear. Parallel outputs in high-impedance OFF-state	X	X	H	L	X	L	Z
Logic high level shifted into the first shift register. Contents of all shift register stages shifted through, e.g. previous state of stage G(internal QG') appears on the serial output(QH').	↑	X	L	H	H	QG'	NC
Contents of shift register stages (internal Qn') are transferred to the storage register and parallel output stages.	X	↑	L	H	X	NC	Qn'
Contents of shift register shifted through. Previous contents of the shift register is transferred to the storage register and the parallel output stages.	↑	↑	L	H	X	QG'	Qn'

Note:H : HIGH voltage level.  
 L : LOW voltage level.  
 X : Don't care.  
 Z : High impedance OFF-state.  
 NC: No change.  
 ↑ : Low-to-High transition.  
 ↓ : High-to-Low transition.

■ LOGIC DIAGRAM (POSITIVE LOGIC)

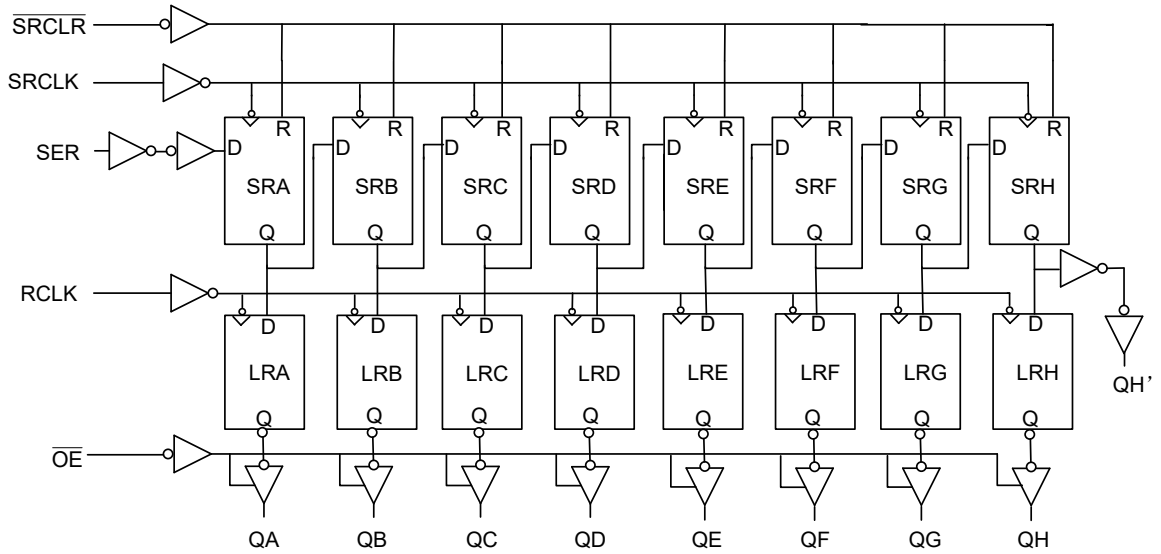

■ TIMING DIAGRAM

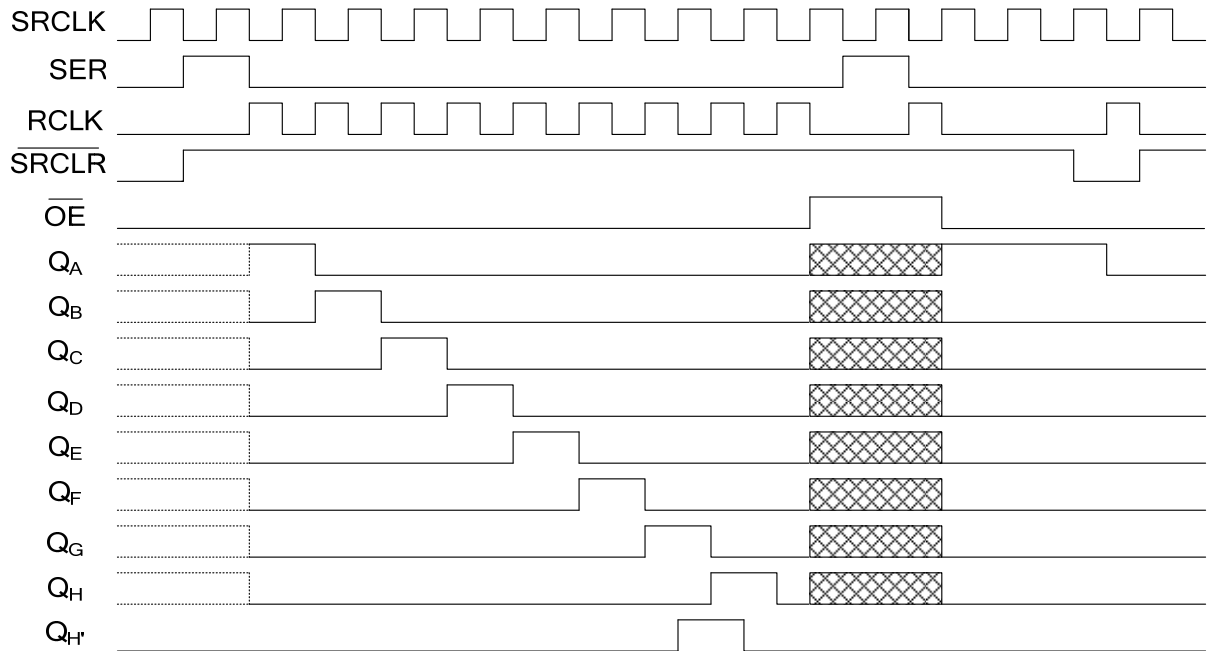

Note:  Implies that the outputs is in 3-State mode.

■ ABSOLUTE MAXIMUM RATING (unless otherwise specified)(Note 2)

PARAMETER	SYMBOL	RATINGS	UNIT
Supply Voltage	$V_{CC}$	-0.5 ~ 7.0	V
Input Voltage	$V_{IN}$	-0.5 ~ 7.0	V
Output Voltage(active mode)	$V_{OUT}$	-0.5 ~ $V_{CC}+0.5$	V
Input Clamp Current ( $V_{IN}<0$ )	$I_{IK}$	-20	mA
Output Clamp Current ( $V_{OUT}<0$ )	$I_{OK}$	±20	mA
Output Current	$I_{OUT}$	±25	mA
$V_{CC}$ or GND Current	$I_{CC}$	±75	mA
Storage Temperature	$T_{STG}$	-65 ~ +150	°C

Notes: 1. Absolute maximum ratings are those values beyond which the device could be permanently damaged.

Absolute maximum ratings are stress ratings only and functional device operation is not implied.

2. The input and output voltage ratings may be exceeded if the input and output current ratings are observed.

■ THERMAL DATA

PARAMETER	SYMBOL	RATINGS	UNIT
Junction to Ambient	$\theta_{JA}$	73	°C/W
		108	

■ RECOMMENDED OPERATING CONDITIONS

PARAMETER	SYMBOL	MIN	TYP	MAX	UNIT
Supply Voltage	$V_{CC}$	2		5.5	V
Input Voltage	$V_{IN}$	0		5.5	V
Output Voltage	$V_{OUT}$	0		$V_{CC}$	V
Input Transition Rise or Fall Rate	$\Delta t/\Delta v$			100	ns/V
				20	
Operating Temperature	$T_A$	-40		+125	°C

■ ELECTRICAL CHARACTERISTICS (Unless otherwise specified)

PARAMETER	SYMBOL	TEST CONDITIONS	T <sub>A</sub> =25°C			T <sub>A</sub> =-40°C~+125°C			UNIT
			MIN	TYP	MAX	MIN	TYP	MAX	
HIGH-level input voltage	V <sub>IH</sub>	V <sub>CC</sub> =2V	1.5			1.5			V
		V <sub>CC</sub> =3V	2.1			2.1			
		V <sub>CC</sub> =5.5V	3.85			3.85			
LOW-level output voltage	V <sub>IL</sub>	V <sub>CC</sub> =2V			0.5			0.5	V
		V <sub>CC</sub> =3V			0.9			0.9	
		V <sub>CC</sub> =5.5V			1.65			1.65	
High-Level Output Voltage	V <sub>OH</sub>	V <sub>CC</sub> =2V, I <sub>OH</sub> =-50μA	1.9	2		1.9			V
		V <sub>CC</sub> =3V, I <sub>OH</sub> =-50μA	2.9	3		2.9			
		V <sub>CC</sub> =4.5V, I <sub>OH</sub> =-50μA	4.4	4.5		4.4			
		V <sub>CC</sub> =3V, I <sub>OH</sub> =-4mA	2.58			2.40			
		V <sub>CC</sub> =4.5V, I <sub>OH</sub> =-8mA	3.94			3.70			
Low-Level Output Voltage	V <sub>OL</sub>	V <sub>CC</sub> =2V, I <sub>OL</sub> =50μA			0.1			0.1	V
		V <sub>CC</sub> =3V, I <sub>OL</sub> =50μA			0.1			0.1	
		V <sub>CC</sub> =4.5V, I <sub>OL</sub> =50μA			0.1			0.1	
		V <sub>CC</sub> =3V, I <sub>OL</sub> =4mA			0.36			0.55	
		V <sub>CC</sub> =4.5V, I <sub>OL</sub> =8mA			0.36			0.55	
Input Leakage Current	I <sub>I(LEAK)</sub>	V <sub>CC</sub> =0 ~ 5.5V, I <sub>IN</sub> =5.5V or GND			±0.1			±2	μA
Output Off-state Current	I <sub>OZ</sub>	V <sub>CC</sub> =5.5V, V <sub>IN</sub> =V <sub>CC</sub> or GND, V <sub>OUT</sub> =V <sub>CC</sub> or GND, $\overline{OE}$ =V <sub>IH</sub> or V <sub>IL</sub>			±0.25			±10	μA
Quiescent Supply Current	I <sub>CC</sub>	V <sub>CC</sub> =5.5V, V <sub>IN</sub> =GND or V <sub>CC</sub> , I <sub>OUT</sub> =0			4			80	μA

■ DYNAMIC CHARACTERISTICS (Unless otherwise specified)

PARAMETER	SYMBOL	TEST CONDITIONS		T <sub>A</sub> =25°C			T <sub>A</sub> =-40°C~+125°C			UNIT
				MIN	TYP	MAX	MIN	TYP	MAX	
Maximum Clock Frequency	f <sub>max</sub>	V <sub>CC</sub> =3.3±0.3V	C <sub>L</sub> =15pF	8	13		5			MHz
			C <sub>L</sub> =50pF	7.5	12		4			MHz
		V <sub>CC</sub> =5±0.5V	C <sub>L</sub> =15pF	18	33		12			MHz
			C <sub>L</sub> =50pF	16	28		10			MHz
Propagation delay from input RCLK to output Q <sub>AH</sub>	t <sub>PLH</sub>	V <sub>CC</sub> =3.3±0.3V	C <sub>L</sub> =15pF		10	14			16	ns
			C <sub>L</sub> =50pF		12	17			19	ns
		V <sub>CC</sub> =5±0.5V	C <sub>L</sub> =15pF		7	10			12	ns
			C <sub>L</sub> =50pF		8	12			14	ns
	t <sub>PHL</sub>	V <sub>CC</sub> =3.3±0.3V	C <sub>L</sub> =15pF		11	14			16	ns
			C <sub>L</sub> =50pF		12	17			19	ns
V <sub>CC</sub> =5±0.5V	C <sub>L</sub> =15pF		7	10			12	ns		
	C <sub>L</sub> =50pF		9	12			14	ns		
Propagation delay from input SRCLK to output QH'	t <sub>PLH</sub>	V <sub>CC</sub> =3.3±0.3V	C <sub>L</sub> =15pF		75	115			200	ns
			C <sub>L</sub> =50pF		80	120			210	ns
		V <sub>CC</sub> =5±0.5V	C <sub>L</sub> =15pF		30	50			90	ns
			C <sub>L</sub> =50pF		35	60			100	ns
	t <sub>PHL</sub>	V <sub>CC</sub> =3.3±0.3V	C <sub>L</sub> =15pF		75	115			200	ns
			C <sub>L</sub> =50pF		80	120			210	ns
V <sub>CC</sub> =5±0.5V	C <sub>L</sub> =15pF		30	50			90	ns		
C <sub>L</sub> =50pF		35	60			100	ns			
Propagation delay from input SRCLR to output QH'	t <sub>PHL</sub>	V <sub>CC</sub> =3.3±0.3V	C <sub>L</sub> =15pF		80	120			220	ns
			C <sub>L</sub> =50pF		83	125			230	ns
		V <sub>CC</sub> =5±0.5V	C <sub>L</sub> =15pF		26	45			80	ns
			C <sub>L</sub> =50pF		30	50			90	ns
Propagation delay from input OE to output Q <sub>AH</sub>	t <sub>PZH</sub>	V <sub>CC</sub> =3.3±0.3V	C <sub>L</sub> =15pF		10	12			15	ns
			C <sub>L</sub> =50pF		11	15			18.5	ns
		V <sub>CC</sub> =5±0.5V	C <sub>L</sub> =15pF		6	8.6			11	ns
			C <sub>L</sub> =50pF		7	10.6			13	ns
	t <sub>PZL</sub>	V <sub>CC</sub> =3.3±0.3V	C <sub>L</sub> =15pF		9	11.5			15.0	ns
			C <sub>L</sub> =50pF		10	15			18.5	ns
V <sub>CC</sub> =5±0.5V	C <sub>L</sub> =15pF		6	8.6			11	ns		
	C <sub>L</sub> =50pF		7	10.6			13	ns		
Propagation delay from input OE to output Q <sub>AH</sub>	t <sub>PHZ</sub>	V <sub>CC</sub> =3.3±0.3V	C <sub>L</sub> =50pF		11	15.7			17.5	ns
		V <sub>CC</sub> =5±0.5V			8	10.3			12	ns
	V <sub>CC</sub> =3.3±0.3V	t <sub>PLZ</sub>			9	15.7			17.5	ns
		V <sub>CC</sub> =5±0.5V			7	10.3			12	ns

■ TIMING REQUIREMENTS (Unless otherwise specified)

PARAMETER	SYMBOL	TEST CONDITIONS	T <sub>A</sub> =25°C			T <sub>A</sub> =-40°C~+125°C			UNIT
			MIN	TYP	MAX	MIN	TYP	MAX	
Pulse duration, SRCLK high or low	t <sub>w</sub>	V <sub>CC</sub> =3.3±0.3V	5			5			ns
		V <sub>CC</sub> =5±0.5V	5			5			ns
Pulse duration, RCLK high or low		V <sub>CC</sub> =3.3±0.3V	5			5			ns
		V <sub>CC</sub> =5±0.5V	5			5			ns
Pulse duration, $\overline{\text{SRCLR}}$ low		V <sub>CC</sub> =3.3±0.3V	5			5			ns
		V <sub>CC</sub> =5±0.5V	5			5			ns
Setup Time, SER before SRCLK↑	t <sub>su</sub>	V <sub>CC</sub> =3.3±0.3V	3.5			3.5			ns
		V <sub>CC</sub> =5±0.5V	3			3			ns
Setup Time, SRCLK↑ before RCLK↑		V <sub>CC</sub> =3.3±0.3V	8			8			ns
		V <sub>CC</sub> =5±0.5V	5			5			ns
Setup Time, $\overline{\text{SRCLR}}$ low before RCLK↑		V <sub>CC</sub> =3.3±0.3V	8			8			ns
		V <sub>CC</sub> =5±0.5V	5			5			ns
Setup Time, $\overline{\text{SRCLR}}$ high (inactive) before SRCLK↑		V <sub>CC</sub> =3.3±0.3V	3			3			ns
		V <sub>CC</sub> =5±0.5V	2.5			2.5			ns
Hold Time, SER after SRCLK↑	t <sub>h</sub>	V <sub>CC</sub> =3.3±0.3V	1.5			1.5			ns
		V <sub>CC</sub> =5±0.5V	2			2			ns

■ OPERATING CHARACTERISTICS (V<sub>CC</sub>=5V, T<sub>A</sub>=25°C, unless otherwise specified)

PARAMETER	SYMBOL	TEST CONDITIONS	MIN	TYP	MAX	UNIT
Input Capacitance	C <sub>IN</sub>	V <sub>CC</sub> =5V, V <sub>IN</sub> =V <sub>CC</sub> or GND		3	10	
Output Capacitance	C <sub>OUT</sub>	V <sub>CC</sub> =5V, V <sub>OUT</sub> =V <sub>CC</sub> or GND		5.5		
Power Dissipation Capacitance	C <sub>PD</sub>	No load, f=1MHz		25.2		pF

■ TEST CIRCUIT AND WAVEFORMS

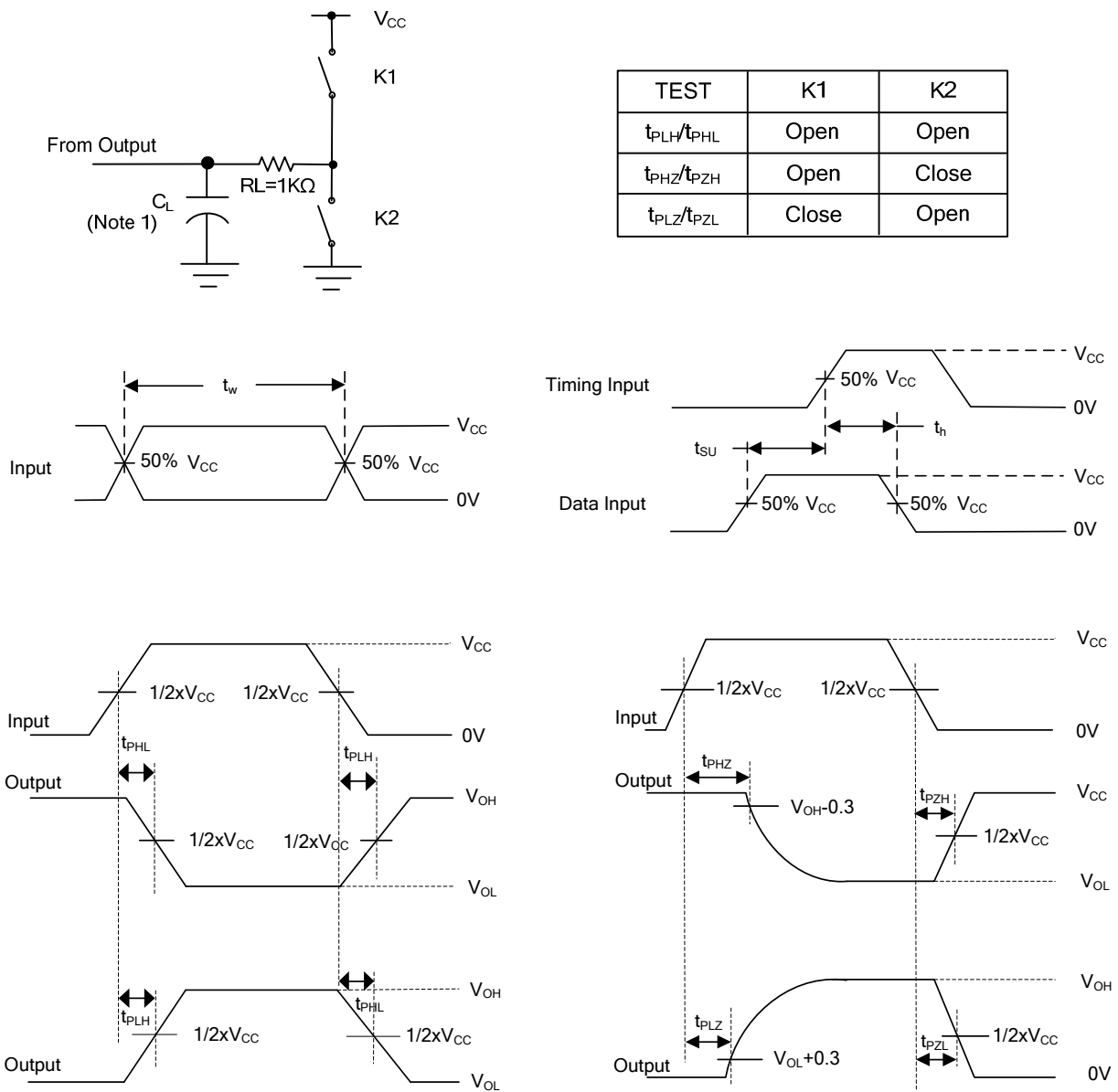

- Note: 1.  $C_L$  includes probe and jig capacitance.  
 2. All input pulses are supplied by generators having the following characteristics:  
 PRR  $\leq 1$ MHZ,  $Z_0=50\Omega$ ,  $t_r \leq 3$ ns,  $t_f \leq 3$ ns.  
 3. The outputs are measured one at a time, with one input transition per measurement.

**Figure 1. Load Circuit and Voltage Waveforms**

UTC assumes no responsibility for equipment failures that result from using products at values that exceed, even momentarily, rated values (such as maximum ratings, operating condition ranges, or other parameters) listed in products specifications of any and all UTC products described or contained herein. UTC products are not designed for use in life support appliances, devices or systems where malfunction of these products can be reasonably expected to result in personal injury. Reproduction in whole or in part is prohibited without the prior written consent of the copyright owner. UTC reserves the right to make changes to information published in this document, including without limitation specifications and product descriptions, at any time and without notice. This document supersedes and replaces all information supplied prior to the publication hereof.