

# μA101A • μA201A • μA301A General Purpose Operational Amplifiers

Linear Division Operational Amplifiers

## Description

The μA101A, μA201A, and μA301A are general purpose monolithic operational amplifiers constructed using the Fairchild Planar Epitaxial process. These integrated circuits are intended for applications requiring low input offset voltage or low input offset current. The accuracy of long interval integrators, timers, and sample-and-hold circuits is improved due to the low drift and low bias currents of the μA101A, μA201A, or μA301A. Frequency response may be matched to the individual circuit need with one external capacitor. The absence of latch up coupled with internal short circuit protection make the μA101A, μA201A and μA301A virtually foolproof.

- Low Offset Current And Voltage
- Low Offset Current Drift
- Low Bias Current
- Short Circuit Protected
- Low Power Consumption

## Absolute Maximum Ratings

Storage Temperature Range	
Metal Can	-65°C to +175°C
Molded DIP and SO-8	-65°C to +150°C
Operating Temperature Range	
Extended (μA101AM)	-55°C to +125°C
Industrial (μA201AV)	-25°C to +85°C
Commercial (μA301AC)	0°C to +70°C
Lead Temperature	
Metal Can (soldering, 60 s)	300°C
Molded DIP and SO-8 (soldering, 10 s)	265°C
Internal Power Dissipation <sup>1, 2</sup>	
8L-Metal Can	1.00 W
8L-Molded DIP	0.93 W
SO-8	0.81 W
Supply Voltage	
μA101A, μA201A	± 22 V
μA301A	± 18 V
Differential Input Voltage	± 30 V
Input Voltage <sup>3</sup>	± 15 V
Output Short Circuit Duration <sup>4</sup>	Indefinite

## Notes

1. T<sub>J</sub> Max = 150°C for the Molded DIP and SO-8, and 175°C for the Metal Can.
2. Ratings apply to ambient temperature at 25°C. Above this temperature, derate the 8L-Metal Can at 6.7 mW/°C, the 8L-Molded DIP at 7.5 mW/°C and the SO-8 at 6.5 mW/°C.
3. For supply voltage less than ± 15 V, the absolute maximum input voltage is equal to the supply voltage.
4. Short circuit may be ground or either supply. μA101A and μA201A ratings apply to +125°C case temperature or +75°C ambient temperature. μA301A ratings apply for case temperatures to 70°C.

## Connection Diagram 8-Lead Metal Package (Top View)

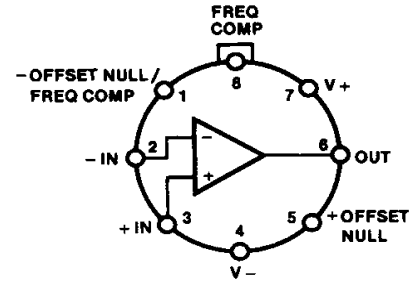

CD00511F

Lead 4 connected to case.

## Order Information

Device Code	Package Code	Package Description
μA101AHM	5W	Metal
μA201AHV	5W	Metal
μA301AHC	5W	Metal

## Connection Diagram 8-Lead DIP and SO-8 Package (Top View)

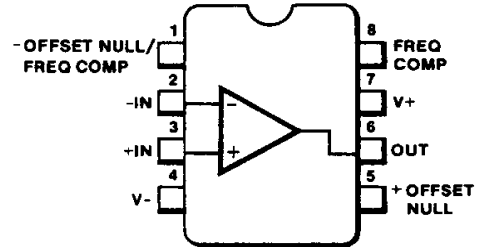

CD00541F

## Order Information

Device Code	Package Code	Package Description
μA301ASC	KC	Molded Surface Mount
μA301ATC	9T	Molded DIP

Equivalent Circuit

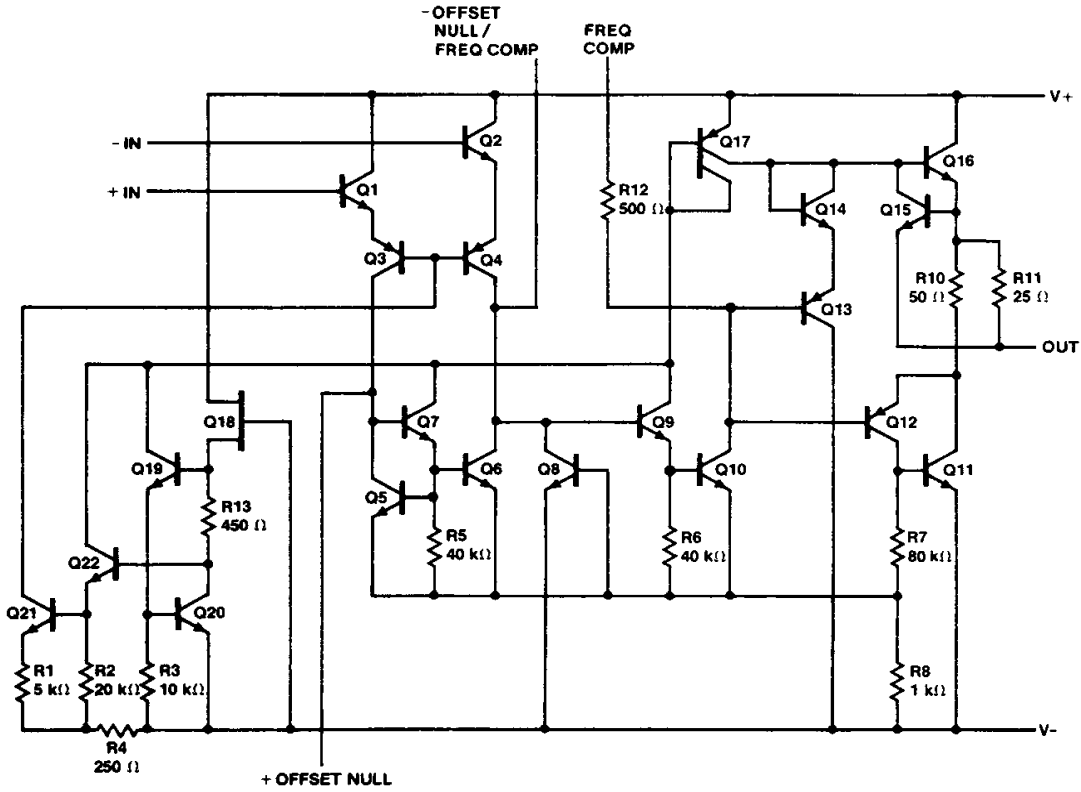

EQ00031F

**μA101A, μA201A and μA301A**

**Electrical Characteristics**  $T_A = 25^\circ\text{C}$ ,  $\pm 5.0\text{ V} \leq V_{CC} \leq \pm 20\text{ V}$  for the μA101A and μA201A,  
 $\pm 5.0\text{ V} \leq V_{CC} \leq \pm 15\text{ V}$  for the μA301A, unless otherwise specified.

Symbol	Characteristic	Condition	μA101A, μA201A			μA301A			Unit
			Min	Typ	Max	Min	Typ	Max	
$V_{IO}$	Input Offset Voltage	$R_S \leq 50\text{ k}\Omega$		0.7	2.0		2.0	7.5	mV
$I_{IO}$	Input Offset Current			1.5	10		3.0	50	nA
$I_{IB}$	Input Bias Current			30	75		70	250	nA
$Z_I$	Input Impedance		1.5	4.0		0.5	2.0		MΩ
$I_{CC}$	Supply Current	$V_{CC} = \pm 20\text{ V}$		1.8	3.0				mA
		$V_{CC} = \pm 15\text{ V}$					1.8	3.0	
$A_{VS}$	Large Signal Voltage Gain	$V_{CC} = \pm 15\text{ V}$ , $V_O = \pm 10\text{ V}$ , $R_L \geq 2.0\text{ k}\Omega$	50	160		25	160		V/mV

The following specifications apply over the range of  $-55^\circ\text{C} \leq T_A \leq +125^\circ\text{C}$  for the μA101A, and  $-25^\circ\text{C} \leq T_A \leq +85^\circ\text{C}$  for the μA201A, and  $0^\circ\text{C} \leq T_A \leq +70^\circ\text{C}$  for the μA301A.

$V_{IO}$	Input Offset Voltage	$R_S \leq 50\text{ k}\Omega$			3.0			10	mV
$\Delta V_{IO}/\Delta T$	Input Offset Voltage Temperature Sensitivity	$T_{A\text{ Min}} \leq T_A \leq T_{A\text{ Max}}$		6.0	15		6.0	30	μV/°C
$I_{IO}$	Input Offset Current				20			70	nA
$\Delta I_{IO}/\Delta T$	Input Offset Current Temperature Sensitivity	$25^\circ\text{C} \leq T_A \leq T_{A\text{ Max}}$		0.01	0.1		0.01	0.3	nA/°C
		$T_{A\text{ Min}} \leq T_A \leq 25^\circ\text{C}$		0.02	0.2		0.02	0.6	
$I_{IB}$	Input Bias Current				100			300	nA
$I_{CC}$	Supply Current	$T_A = T_{A\text{ Max}}$ , $V_{CC} = \pm 20\text{ V}$		1.2	2.5				mA
CMR	Common Mode Rejection	$R_S \leq 50\text{ k}\Omega$	80	96		70	90		dB
$V_{IR}$	Input Voltage Range	$V_{CC} = \pm 20\text{ V}$	$\pm 15$						V
		$V_{CC} = \pm 15\text{ V}$				$\pm 12$			
PSRR	Power Supply Rejection Ratio	$R_S \leq 50\text{ k}\Omega$	80	96		70	96		dB
$A_{VS}$	Large Signal Voltage Gain	$V_{CC} = \pm 15\text{ V}$ , $V_O = \pm 10\text{ V}$ , $R_L \geq 2.0\text{ k}\Omega$	25			15			V/mV
$V_{OP}$	Output Voltage Swing	$V_{CC} = \pm 15\text{ V}$	$R_L = 10\text{ k}\Omega$	$\pm 12$	$\pm 14$		$\pm 12$	$\pm 14$	V
			$R_L = 2.0\text{ k}\Omega$	$\pm 10$	$\pm 13$		$\pm 10$	$\pm 13$	

**Typical Performance Curves**

**Input Voltage Range vs Supply Voltage ( $\mu A101A$  and  $201A$ )**

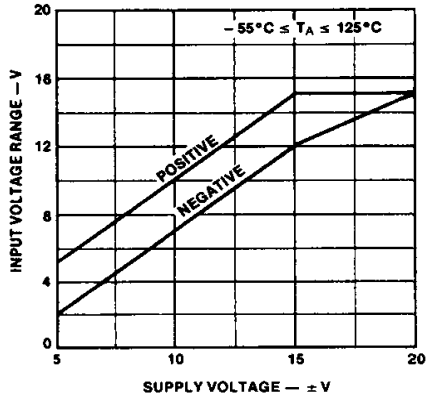

PC04281F

**Output Swing vs Supply Voltage ( $\mu A101A$  and  $201A$ )**

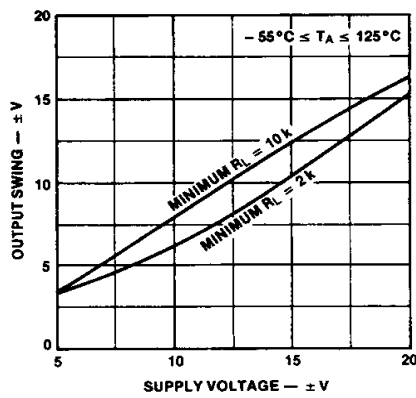

PC04290F

**Voltage Gain vs Supply Voltage ( $\mu A101A$  and  $201A$ )**

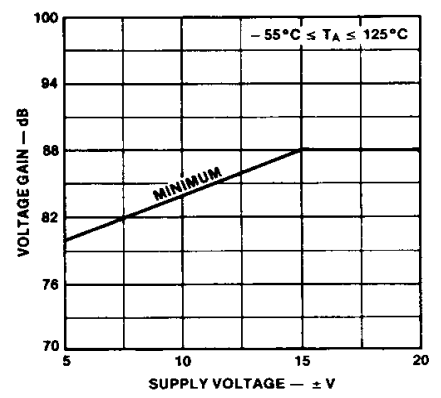

PC04300F

**Input Voltage Range vs Supply Voltage ( $\mu A301A$ )**

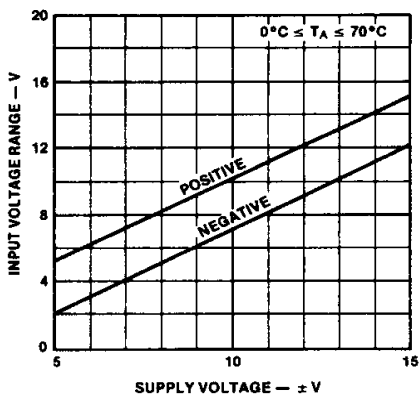

PC04311F

**Output Swing vs Supply Voltage ( $\mu A301A$ )**

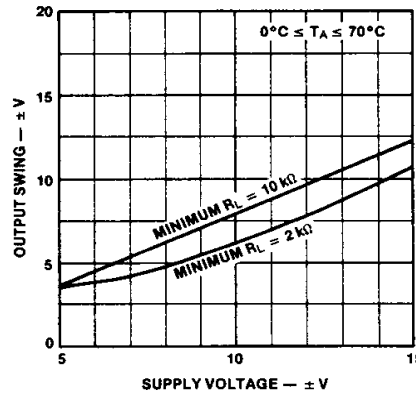

PC04320F

**Voltage Gain vs Supply Voltage ( $\mu A301A$ )**

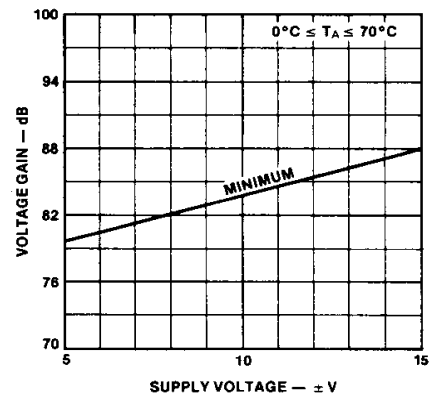

PC04330F

**Open Loop Frequency Response ( $\mu A101A$ ,  $201A$ , and  $301A$ )**

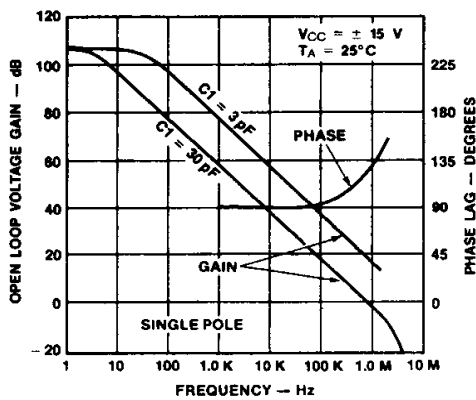

PC04341F

**Open Loop Frequency Response ( $\mu A101A$ ,  $201A$ , and  $301A$ )**

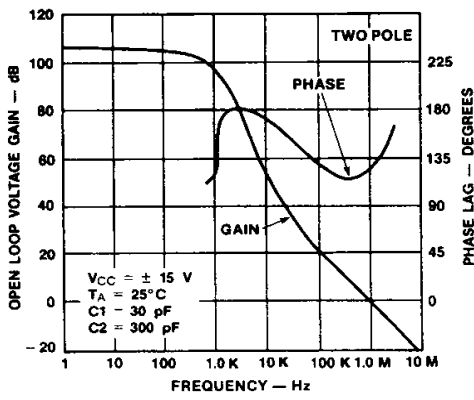

PC04351F

**Open Loop Frequency Response ( $\mu A101A$ ,  $201A$ , and  $301A$ )**

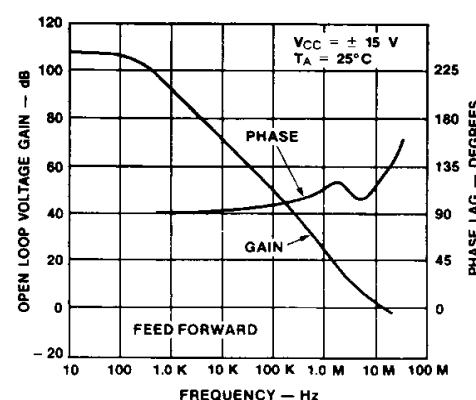

PC04361F

Typical Performance Curves for  $\mu A101A$ ,  $\mu A201A$ , and  $\mu A301A$  (Cont.)

Large Signal Frequency Response

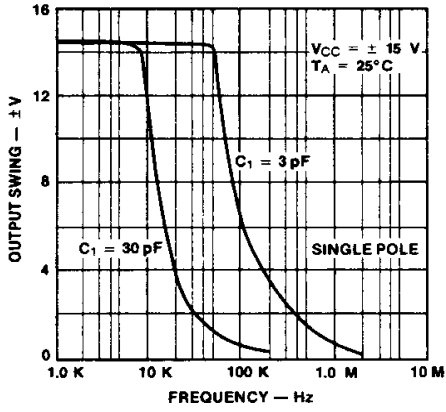

PC04371F

Large Signal Frequency Response

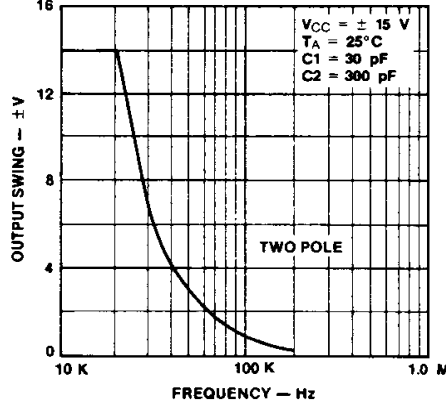

PC04381F

Large Signal Frequency Response

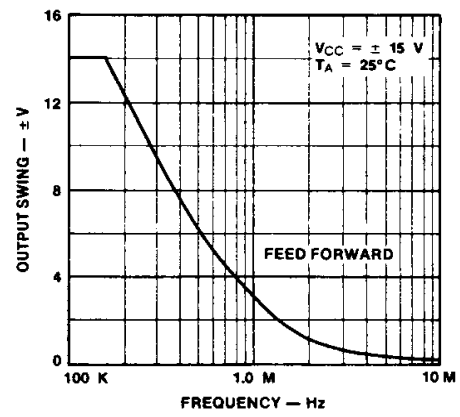

PC04391F

Voltage Follower Pulse Response

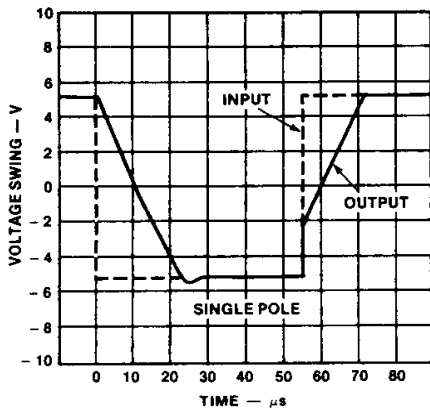

PC04400F

Voltage Follower Pulse Response

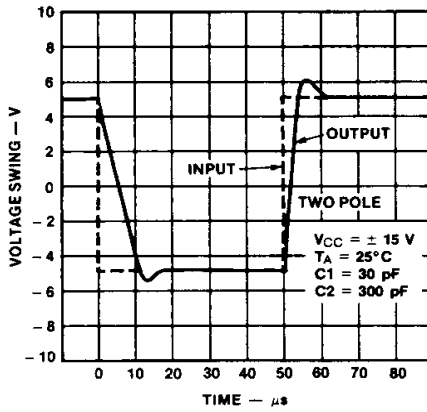

PC04410F

Voltage Follower Pulse Response

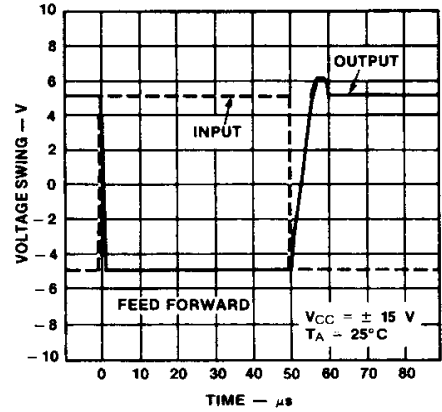

PC04421F

Supply Voltage Current vs Supply Voltage

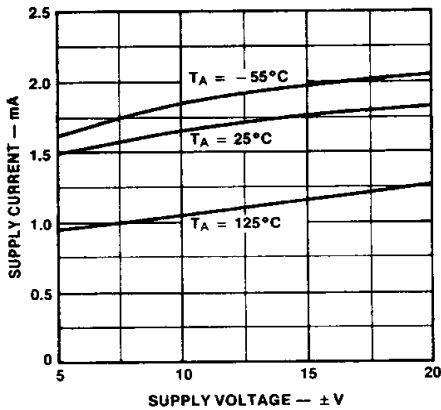

PC04431F

Voltage Gain vs Supply Voltage

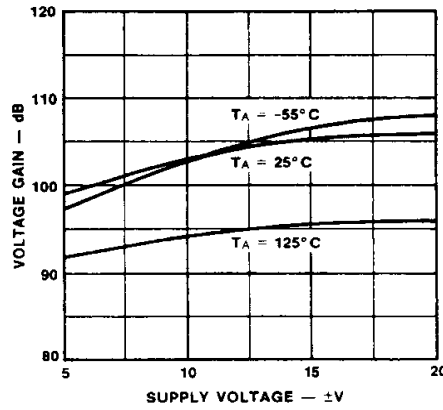

PC04441F

Current Limiting

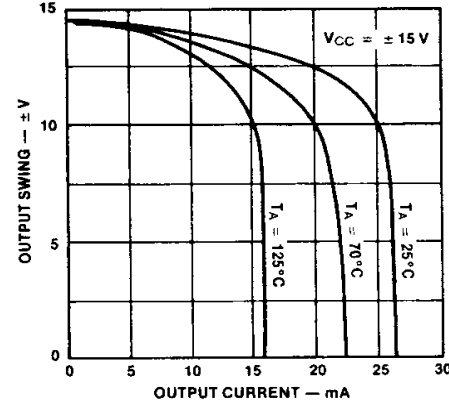

PC04450F

Typical Performance Curves for  $\mu A101A$ ,  $\mu A201A$ , and  $\mu A301A$  (Cont.)

Input Current vs Temperature ( $\mu A101A$  and  $\mu A201A$ )

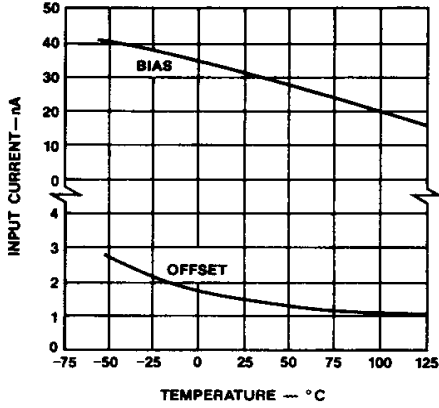

PC04460F

Input Current vs Temperature ( $\mu A301A$  only)

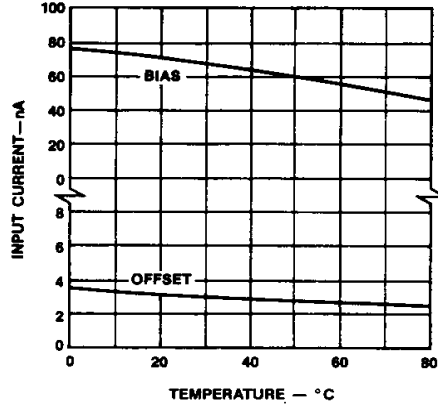

PC04470F

Input Noise Voltage vs Frequency

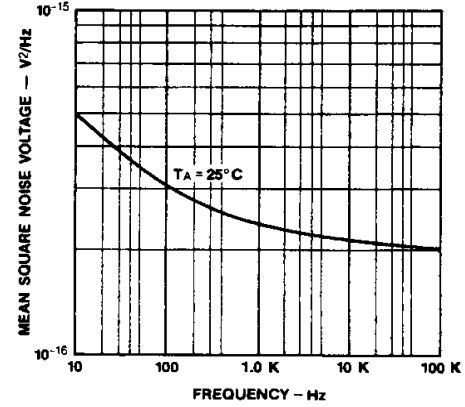

PC04481F

Input Noise Current vs Frequency ( $\mu A101A$  and  $\mu A201A$ )

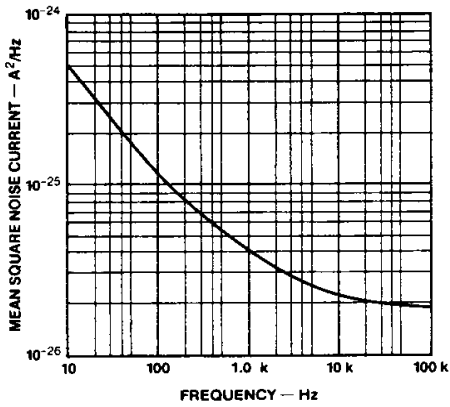

PC04490F

Input Noise Current vs Frequency ( $\mu A301A$ )

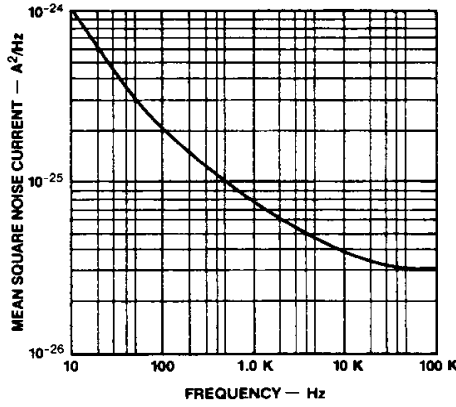

PC04501F

Common Mode Rejection vs Frequency

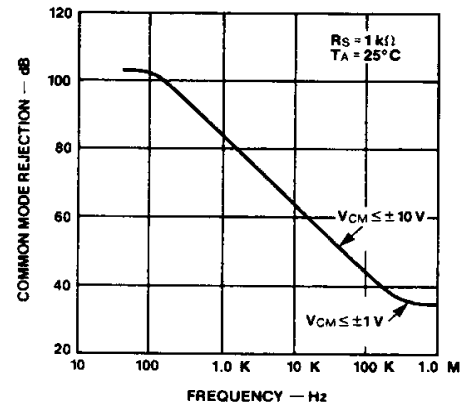

PC04521F

Supply Rejection vs Frequency

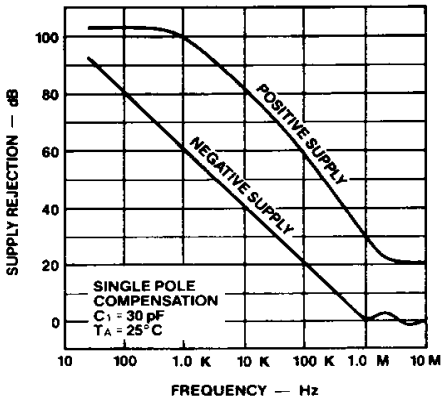

PC04511F

Closed Loop Output Impedance vs Frequency

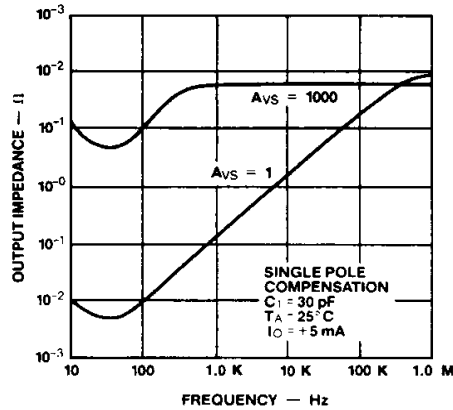

PC04531F

**Compensation Circuits (Note 2)**

**Single Pole Compensation**

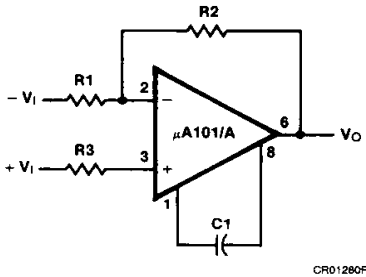

$$C_1 \geq \frac{R_1 C_s}{R_1 + R_2}$$

$$C_s = 30 \text{ pF}$$

**Two Pole Compensation**

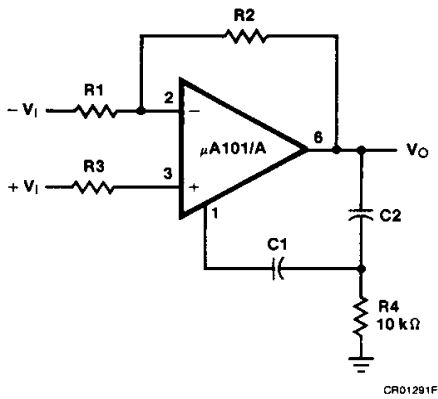

$$C_1 \geq \frac{R_1 C_s}{R_1 + R_2}$$

$$C_s = 30 \text{ pF}$$

$$C_2 = 10 C_1$$

**Feed Forward Compensation**

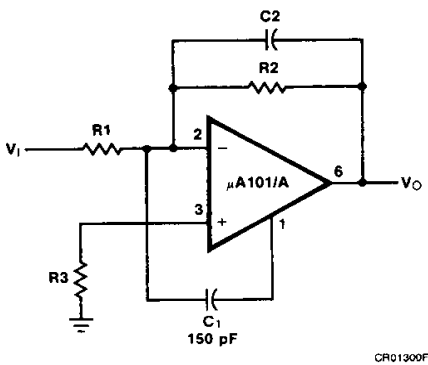

**Typical Applications (Note 2)**

**Fast Voltage Follower**

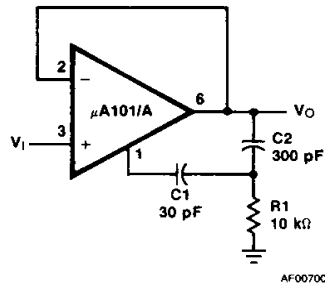

Power Bandwidth: 15 kHz  
Slew Rate: 1 V/μs

**Inverting Amplifier With Balancing Circuit**

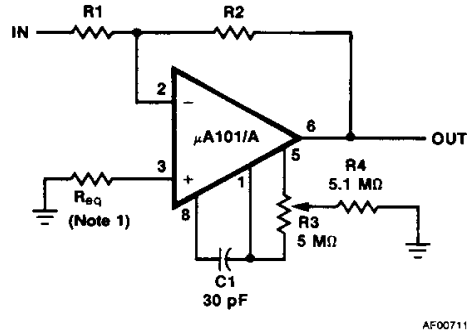

**Voltage Comparator For Driving Or DTL Integrated Circuits**

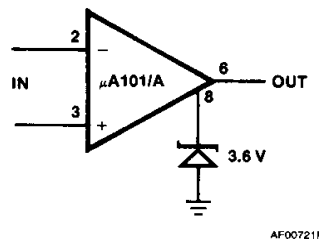

**Notes**

1. May be zero or equal to parallel combination of R1 and R2 for minimum offset.
2. All lead numbers shown refer to 8-lead metal package.

**Typical Applications (Cont.) (Note 2)**

**Low Frequency Square Wave Generator**

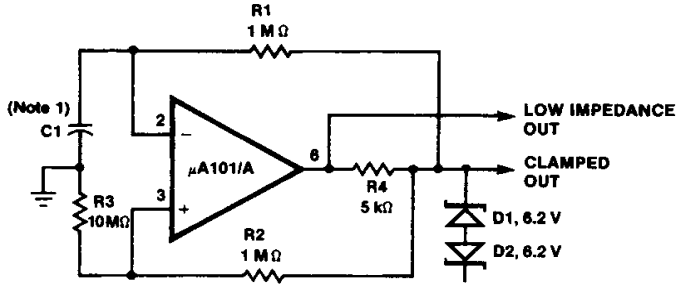

AF00731F

**Practical Differentiator**

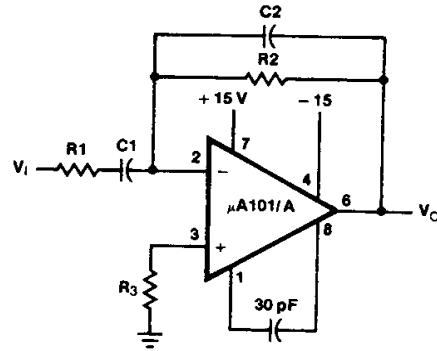

AF00741F

**Circuit For Operating Without A Negative Supply**

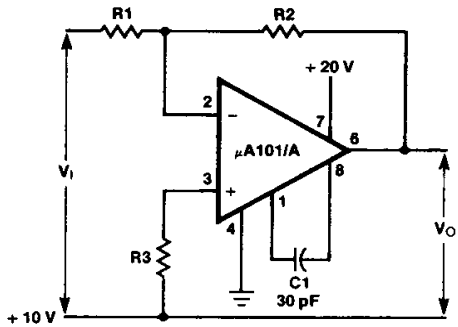

AF00750F

$$f_c = \frac{1}{2\pi R_2 C_1}$$

$$f_h = \frac{1}{2\pi R_1 C_1} = \frac{1}{2\pi R_2 C_2}$$

$$f_c < f_h < f_{\text{unity gain}}$$

**Notes**

1. Adjust  $C_1$  for frequency
2. All lead numbers shown refer to 8-lead metal package