

μA107 • μA207 • μA307

GENERAL-PURPOSE OPERATIONAL AMPLIFIERS

FAIRCHILD LINEAR INTEGRATED CIRCUITS

GENERAL DESCRIPTION – The μA107 General Purpose Operational Amplifier series is constructed using the Fairchild Planar* epitaxial process. Advanced processing techniques have reduced the 107 input current an order of magnitude below industry standards such as the μA709 while still replacing, pin-for-pin, μA709, μA101, μA101A, and μA741. The μA107, μA207, and μA307 offer better accuracy, internal compensation, and lower noise for high impedance circuit applications while providing features similar to the μA101A. The low input currents allow the device to be used in slow-charge applications such as long period integrators, slow ramps, and sample-and-hold circuits. The μA207 is identical to the μA107 except that the μA207 performance is guaranteed from -25°C to $+85^{\circ}\text{C}$ while the μA107 performance is guaranteed over a -55°C to $+125^{\circ}\text{C}$ temperature range. The μA307 is available in both TO-99 and 8-pin mini DIP packages and is guaranteed over a 0°C to $+70^{\circ}\text{C}$ temperature range.

- LOW OFFSET VOLTAGE
- LOW INPUT CURRENT
- LOW OFFSET CURRENT
- GUARANTEED DRIFT CHARACTERISTICS
- GUARANTEED OFFSETS OVER COMMON MODE RANGE

EQUIVALENT CIRCUIT

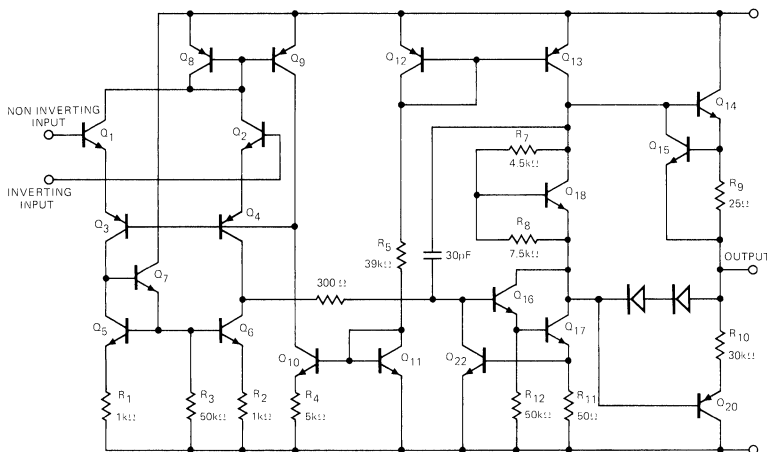

Pin connections shown are for metal can.

CONNECTION DIAGRAMS 8-PIN METAL CAN

(TOP VIEW)
PACKAGE OUTLINE 5S
PACKAGE CODE H

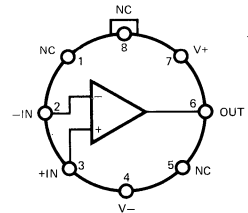

Note: Pin 4 connected to case.

ORDER INFORMATION

TYPE	PART NO.
μA107	μA107HM
μA207	μA207HM
μA307	μA307HC

8-PIN MINI DIP

(TOP VIEW)
PACKAGE OUTLINE 9T
PACKAGE CODE T

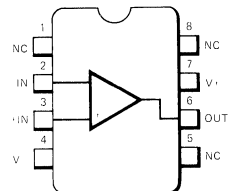

ORDER INFORMATION

TYPE	PART NO.
μA307	μA307TC

Dual In-line Package
and Flatpak Available
By Special Request

*Planar is patented Fairchild process.

FAIRCHILD • μ A107 • μ A207 • μ A307

ABSOLUTE MAXIMUM RATINGS

Supply Voltage		
Military and Instrument (μ A107 and μ A207)		±22 V
Commercial (μ A307)		±18 V
Internal Power Dissipation (Note 1)		
Metal Can		500 mW
Mini DIP		310 mW
Differential Input Voltage		±30 V
Input Voltage (Note 2)		±15 V
Storage Temperature Range		
Metal Can		-65°C to +150°C
Mini DIP		-55°C to +125°C
Operating Temperature Range		
Military (μ A107)		-55°C to +125°C
Instrument (μ A207)		-25°C to +85°C
Commercial (μ A307)		0°C to +70°C
Pin Temperature (Soldering)		
Metal Can (60 s)		300°C
Mini DIP (10 s)		260°C
Output Short Circuit Duration (μ A107 and μ A207)		Indefinite
(μ A307, Note 3)		Indefinite

NOTES:

1. Rating applies to ambient temperatures up to 70°C. Above 70°C ambient derate linearly at 6.3 mW/°C for metal can and 5.6 mW/°C for the mini DIP.
2. For supply voltages less than ±15 V, the absolute maximum input voltage is equal to the supply voltage.
3. Continuous short circuit is allowed for case temperatures to 70°C and ambient temperatures to 55°C.

μ A107 and μ A207

ELECTRICAL CHARACTERISTICS: $\pm 5.0 \text{ V} \leq V_S \leq \pm 20 \text{ V}$, $T_A = 25^\circ\text{C}$ for μ A107 and μ A207 unless otherwise specified.

CHARACTERISTICS	CONDITIONS	MIN	TYP	MAX	UNITS
Input Offset Voltage	$R_S \leq 50 \text{ k}\Omega$		0.7	2.0	mV
Input Offset Current			1.5	10	nA
Input Bias Current			30	75	nA
Input Resistance		1.5	4.0		M Ω
Supply Current	$V_S = \pm 20 \text{ V}$		1.8	3.0	mA
Large Signal Voltage Gain	$V_S = \pm 15 \text{ V}$ $V_{OUT} = \pm 10 \text{ V}$, $R_L \geq 2 \text{ k}\Omega$	50	160		V/mV
The following applies for $55^\circ\text{C} \leq T_A \leq 125^\circ\text{C}$ unless otherwise specified					
Input Offset Voltage	$R_S \leq 50 \text{ k}\Omega$			3.0	mV
Average Temperature Coefficient of Input Offset Voltage			3.0	15	$\mu\text{V}/^\circ\text{C}$
Input Offset Current				20	nA
Average Temperature Coefficient of Input Offset Current	$25^\circ\text{C} \leq T_A \leq 125^\circ\text{C}$		0.01	0.1	$\text{nA}/^\circ\text{C}$
	$-55^\circ\text{C} \leq T_A \leq 25^\circ\text{C}$		0.02	0.2	$\text{nA}/^\circ\text{C}$
Input Bias Current				100	nA
Supply Current	$T_A = +125^\circ\text{C}$, $V_S = \pm 20 \text{ V}$		1.2	2.5	mA
Large Signal Voltage Gain	$V_S = \pm 15 \text{ V}$, $V_{OUT} = \pm 10 \text{ V}$ $R_L \geq 2 \text{ k}\Omega$	25			V/mV
Output Voltage Swing	$V_S = \pm 15 \text{ V}$ $R_L = 10 \text{ k}\Omega$ $R_L = 2 \text{ k}\Omega$	±12 ±10	±14 ±13		V V
Input Voltage Range	$V_S = \pm 20 \text{ V}$		±15		V
Common Mode Rejection Ratio	$R_S \leq 50 \text{ k}\Omega$	80	96		dB
Supply Voltage Rejection Ratio	$R_S \leq 50 \text{ k}\Omega$	80	96		dB

FAIRCHILD • μ A107 • μ A207 • μ A307

μ A307

ELECTRICAL CHARACTERISTICS: $\pm 5.0 \text{ V} \leq V_S \leq \pm 15 \text{ V}$, $T_A = 25^\circ\text{C}$ unless otherwise specified.

CHARACTERISTICS	CONDITIONS	MIN	TYP	MAX	UNITS
Input Offset Voltage	$R_S \leq 50 \text{ k}\Omega$		2.0	7.5	mV
Input Offset Current			3.0	50	nA
Input Bias Current			70	250	nA
Input Resistance		0.5	2.0		$\text{M}\Omega$
Supply Current	$V_S = \pm 15 \text{ V}$		1.8	3.0	mA
Large Signal Voltage Gain	$V_S = \pm 15 \text{ V}$ $V_{OUT} = \pm 10 \text{ V}$, $R_L \geq 2 \text{ k}\Omega$	25	160		V/mV
The following specifications apply for $0^\circ\text{C} \leq T_A \leq 70^\circ\text{C}$					
Input Offset Voltage	$R_S \leq 50 \text{ k}\Omega$			10	mV
Average Temperature Coefficient of Input Offset Voltage			6.0	30	$\mu\text{V}/^\circ\text{C}$
Input Offset Current				70	nA
Average Temperature Coefficient of Input Offset Current	$25^\circ\text{C} \leq T_A \leq 70^\circ\text{C}$ $0^\circ\text{C} \leq T_A \leq 25^\circ\text{C}$		0.01 0.02	0.3 0.6	$\text{nA}/^\circ\text{C}$ $\text{nA}/^\circ\text{C}$
Input Bias Current				300	nA
Large Signal Voltage Gain	$V_S = \pm 15 \text{ V}$, $V_{OUT} = \pm 10 \text{ V}$ $R_L \geq 2 \text{ k}\Omega$	15			V/mV
Output Voltage Swing	$V_S = \pm 15 \text{ V}$	$R_L = 10 \text{ k}\Omega$	± 12	± 14	V
		$R_L = 2 \text{ k}\Omega$	± 10	± 13	V
Input Voltage Range	$V_S = \pm 15 \text{ V}$	± 12			V
Common Mode Rejection Ratio	$R_S \leq 50 \text{ k}\Omega$	70	90		dB
Supply Voltage Rejection Ratio	$R_S \leq 50 \text{ k}\Omega$	70	96		dB

GUARANTEED PERFORMANCE CURVES FOR μ A107 AND μ A207

**INPUT VOLTAGE RANGE
AS A FUNCTION OF
SUPPLY VOLTAGE**

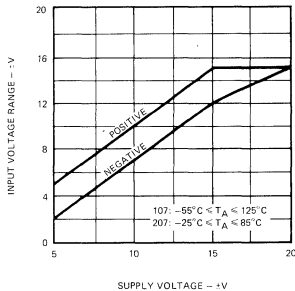

**OUTPUT SWING
AS A FUNCTION OF
SUPPLY VOLTAGE**

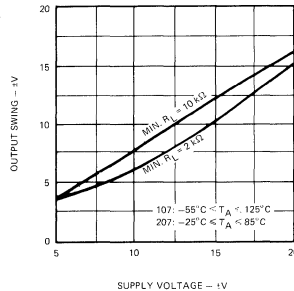

**VOLTAGE GAIN
AS A FUNCTION OF
SUPPLY VOLTAGE**

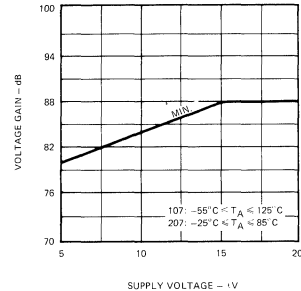

GUARANTEED PERFORMANCE CURVES FOR μ A307

**INPUT VOLTAGE RANGE
AS A FUNCTION OF
SUPPLY VOLTAGE**

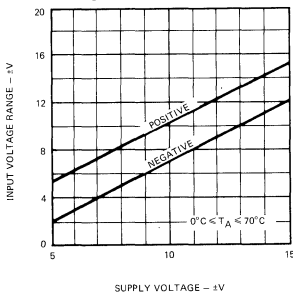

**OUTPUT SWING
AS A FUNCTION OF
SUPPLY VOLTAGE**

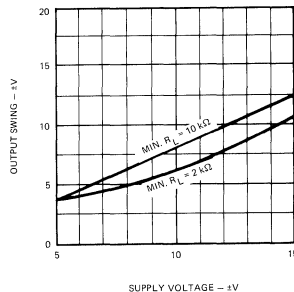

**VOLTAGE GAIN
AS A FUNCTION OF
SUPPLY VOLTAGE**

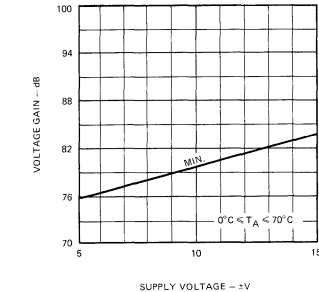

TYPICAL PERFORMANCE CURVES FOR μ A107 AND μ A207

VOLTAGE GAIN AS A FUNCTION OF SUPPLY VOLTAGE

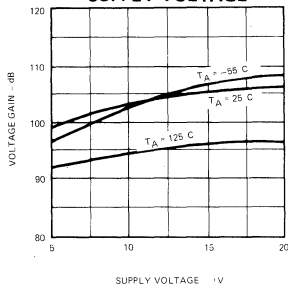

INPUT CURRENT AS A FUNCTION OF SUPPLY VOLTAGE

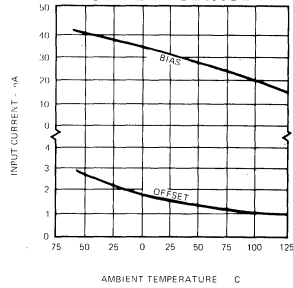

CURRENT LIMITING

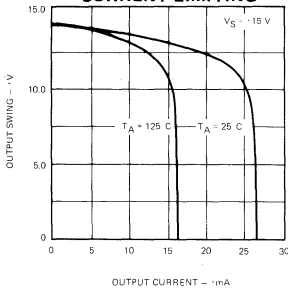

INPUT NOISE CURRENT AS A FUNCTION OF FREQUENCY

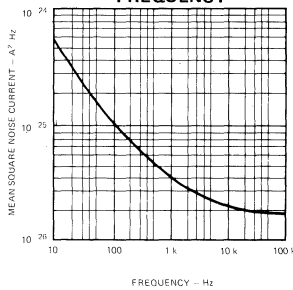

TYPICAL PERFORMANCE CURVES FOR μ A307

VOLTAGE GAIN AS A FUNCTION OF SUPPLY VOLTAGE

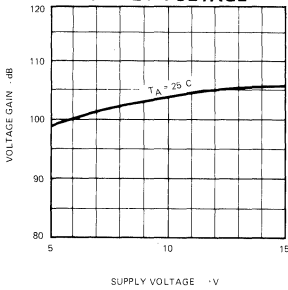

INPUT CURRENT AS A FUNCTION OF AMBIENT TEMPERATURE

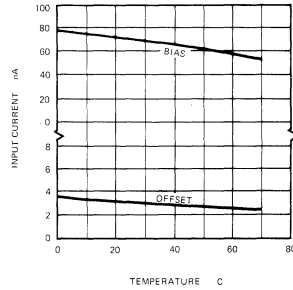

CURRENT LIMITING

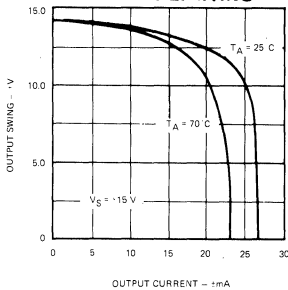

INPUT NOISE CURRENT AS A FUNCTION OF FREQUENCY

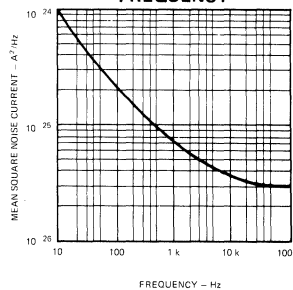

TYPICAL PERFORMANCE CURVES

INPUT NOISE VOLTAGE AS A FUNCTION OF FREQUENCY

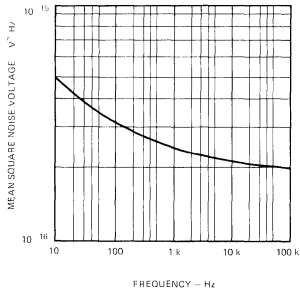

OPEN LOOP FREQUENCY RESPONSE

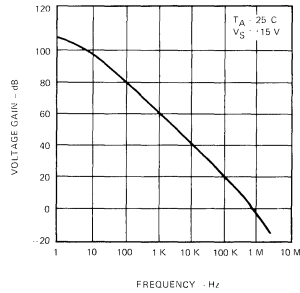

LARGE SIGNAL FREQUENCY RESPONSE

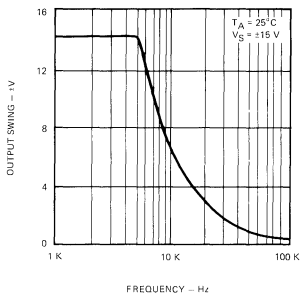

VOLTAGE FOLLOWER PULSE RESPONSE

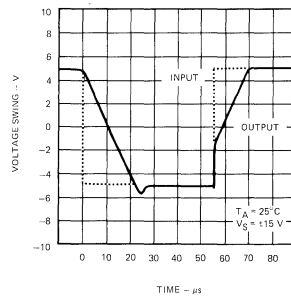

TYPICAL APPLICATIONS

(All pin numbers shown refer to 8-pin TO-5 package)

NON-INVERTING AMPLIFIER

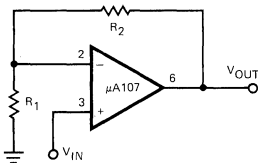

$$V_{OUT} = \frac{R_1 + R_2}{R_1} V_{IN}$$

NON-INVERTING AC AMPLIFIER

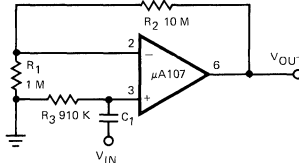

$$V_{OUT} = \frac{R_1 + R_2}{R_1} V_{IN}$$

$$R_{IN} = R_3$$

$$R_3 = R_1 R_2$$

INVERTING AMPLIFIER

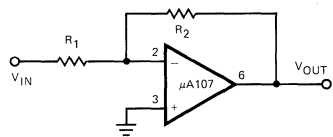

$$V_{OUT} = \frac{R_2}{R_1} V_{IN}$$

$$R_{IN} = R_1$$