

# $\mu$ A148 • $\mu$ A248 • $\mu$ A348 $\mu$ A149 • $\mu$ A249 • $\mu$ A349 QUAD OPERATIONAL AMPLIFIERS FAIRCHILD LINEAR INTEGRATED CIRCUITS

**GENERAL DESCRIPTION** — The  $\mu$ A148 series is a true quad  $\mu$ A741. It consists of four independent, high gain, internally compensated, low power operational amplifiers which have been designed to provide functional characteristics identical to those of the familiar  $\mu$ A741 operational amplifier. In addition, the total supply current for all four amplifiers is comparable to the supply current of a single  $\mu$ A741 type op amp.

Other features include input offset currents and input bias current which are much less than those of a standard  $\mu$ A741. Also, excellent isolation between amplifiers has been achieved by independently biasing each amplifier and using layout techniques which minimize thermal coupling. The  $\mu$ A149 series has the same features as the  $\mu$ A148 except that it is decompensated to give a gain bandwidth product of 4 MHz typical at a gain greater than 5.

- $\mu$ A741 OP AMP OPERATING CHARACTERISTICS
- LOW SUPPLY CURRENT DRAIN
- CLASS AB OUTPUT STAGE - NO CROSSOVER DISTORTION
- PIN COMPATIBLE WITH THE  $\mu$ A324 &  $\mu$ A3403
- LOW INPUT OFFSET VOLTAGE — 1 mV TYP
- LOW INPUT OFFSET CURRENT — 4 nA TYP
- LOW INPUT BIAS CURRENT — 30 nA TYP
- GAIN BANDWIDTH PRODUCT
  - $\mu$ A148 (UNITY GAIN) — 1.0 MHz TYP
  - $\mu$ A149 (AV>5) — 4 MHz TYP
- HIGH DEGREE OF ISOLATION BETWEEN AMPLIFIERS — 120 dB
- OVERLOAD PROTECTION FOR INPUTS AND OUTPUTS

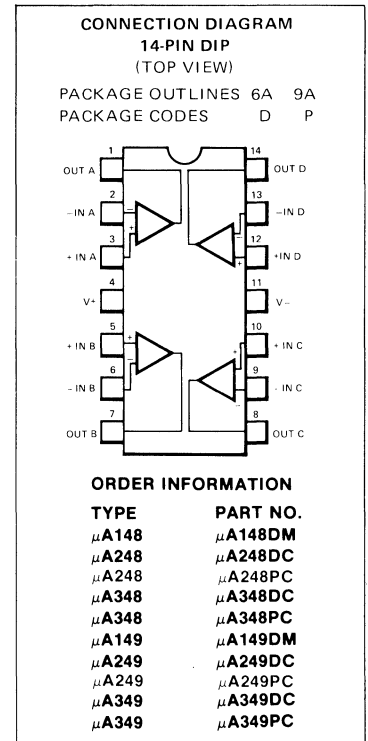

## ABSOLUTE MAXIMUM RATINGS

	$\mu$ A148/ $\mu$ A149	$\mu$ A248/ $\mu$ A249	$\mu$ A348/ $\mu$ A349
Supply Voltage	$\pm 22$ V	$\pm 18$ V	$\pm 18$ V
Differential Input Voltage	$\pm 44$ V	$\pm 36$ V	$\pm 36$ V
Input Voltage	$\pm 22$ V	$\pm 18$ V	$\pm 18$ V
Output Short Circuit Duration (Note 1)	continuous	continuous	continuous
Power Dissipation ( $P_D$ at 25°C) and Thermal Resistance ( $\theta_{JA}$ ), (Note 2)			
Plastic DIP	$P_D$	--	700 mW
	$\theta_{JA}$	--	150°C/W
Ceramic DIP	$P_D$	670 mW	670 mW
	$\theta_{JA}$	100°C/W	100°C/W
Operating Temperature Range	-55°C < $T_A$ < +125°C	-25°C < $T_A$ < +85°C	0°C < $T_A$ < +70°C
Storage Temperature Range	-65°C to +150°C	-65°C to +150°C	-65°C to +150°C
Pin Temperature			
Molded Package (Soldering, 10 s)		260°C	260°C
Hermetic Package (Soldering, 60 s)	300°C	300°C	300°C

# FAIRCHILD • $\mu$ A148/ $\mu$ A149 SERIES

**DC ELECTRICAL CHARACTERISTICS:**  $V_S = \pm 15$  V,  $T_A = 25^\circ\text{C}$  unless otherwise noted

CHARACTERISTIC	CONDITIONS	$\mu$ A148/ $\mu$ A149			UNITS
		MIN	TYP	MAX	
Input Offset Voltage	$R_s \leq 10$ k $\Omega$		1.0	5.0	mV
Input Offset Current			4	25	nA
Input Bias Current			30	100	nA
Input Resistance		0.8	2.5		M $\Omega$
Supply Current All Amplifiers	$V_{OUT} = \pm 10$ V, $R_L \geq 2$ k $\Omega$ $f = 1$ Hz to 20 kHz (Input Referred)		2.4	3.6	mA
Large Signal Voltage Gain		50	160		V/mV
Amplifier to Amplifier			-120		dB
Coupling					
Output Short Circuit Current			25		mA

The following specification apply for  $-55^\circ\text{C} \leq T_A \leq +125^\circ\text{C}$

Input Offset Voltage	$R_s \leq 10$ k $\Omega$			6.0	mV
Input Offset Current				75	nA
Input Bias Current				325	nA
Large Signal Voltage Gain	$R_L \geq 2$ k $\Omega$ , $V_{OUT} = \pm 10$ V	25			V/mV
Output Voltage Swing	$R_L = 10$ k $\Omega$	$\pm 12$	$\pm 13$		V
	$R_L = 2$ k $\Omega$	$\pm 10$	$\pm 12$		V
Input Voltage Range		$\pm 12$			V
Common-Mode Rejection Ratio	$R_s \leq 10$ k $\Omega$	70	90		dB
Supply Voltage Rejection	$R_s \leq 10$ k $\Omega$	77	96		dB

**AC CHARACTERISTICS:**  $V_S = \pm 15$  V,  $T_A = 25^\circ\text{C}$  unless otherwise noted

Small Signal Bandwidth	$\mu$ A148		1.0		MHz
	$\mu$ A149		4.0		MHz
Phase Margin	$\mu$ A148 ( $A_v = 1$ )		60		degrees
	$\mu$ A149 ( $A_v = 5$ )		60		degrees
Slew Rate	$\mu$ A148 ( $A_v = 1$ )		0.5		V/ $\mu$ s
	$\mu$ A149 ( $A_v = 5$ )		2.0		V/ $\mu$ s

**NOTES:**

- Any of the amplifier outputs can be shorted to ground indefinitely; however, more than one should not be simultaneously shorted as the maximum junction temperature will be exceeded.
- The maximum power dissipation for these devices must be derated at elevated temperatures and is dictated by  $T_{J(MAX)}$ ,  $\theta_{JA}$ , and the ambient temperature,  $T_A$ . The maximum available power dissipation at any temperature is  $P_D = (T_{J(MAX)} - T_A)/\theta_{JA}$  or the  $25^\circ\text{C } P_{D(MAX)}$ , whichever is less.
- $\mu$ A148, 248, 348 are capable of driving 100 pF capacitive load.  $\mu$ A149, 249, 349 are capable of driving 50 pF capacitive load.

5

# FAIRCHILD • $\mu$ A148/ $\mu$ A149 SERIES

**DC ELECTRICAL CHARACTERISTICS:**  $V_S = \pm 15$  V,  $T_A = 25^\circ$  C unless otherwise noted

CHARACTERISTIC	CONDITIONS	$\mu$ A248/ $\mu$ A249			UNITS
		MIN	TYP	MAX	
Input Offset Voltage	$R_s \leq 10$ k $\Omega$		1.0	6.0	mV
Input Offset Current			4	50	nA
Input Bias Current			30	200	nA
Input Resistance		0.8	2.5		M $\Omega$
Supply Current All Amplifiers	$V_{OUT} = \pm 10$ V, $R_L \geq 2$ k $\Omega$ $f = 1$ Hz to 20 kHz (Input Referred)		2.4	4.5	mA
Large Signal Voltage Gain		25	160		V/mV
Amplifier to Amplifier Coupling			-120		dB
Output Short Circuit Current			25		mA

The following specification apply for  $-25^\circ$  C  $\leq T_A \leq 85^\circ$  C

Input Offset Voltage	$R_s \leq 10$ k $\Omega$			7.5	mV
Input Offset Current				125	nA
Input Bias Current				500	nA
Large Signal Voltage Gain	$R_L \geq 2$ k $\Omega$ , $V_{OUT} = \pm 10$ V	15			V/mV
Output Voltage Swing	$R_L = 10$ k $\Omega$	$\pm 12$	$\pm 13$		V
	$R_L = 2$ k $\Omega$	$\pm 10$	$\pm 12$		V
Input Voltage Range		$\pm 12$			V
Common-Mode Rejection Ratio	$R_s \leq 10$ k $\Omega$	70	90		dB
Supply Voltage Rejection	$R_s \leq 10$ k $\Omega$	77	96		dB

**AC CHARACTERISTICS:**  $V_S = \pm 15$  V,  $T_A = 25^\circ$  C unless otherwise noted

Small Signal Bandwidth	$\mu$ A248		1.0		MHz
	$\mu$ A249		4.0		MHz
Phase Margin	$\mu$ A248 ( $A_v = 1$ )		60		degrees
	$\mu$ A249 ( $A_v = 5$ )		60		degrees
Slew Rate	$\mu$ A248 ( $A_v = 1$ )		0.5		V/ $\mu$ s
	$\mu$ A249 ( $A_v = 5$ )		2.0		V/ $\mu$ s

**NOTES:**

- Any of the amplifier outputs can be shorted to ground indefinitely; however, more than one should not be simultaneously shorted as the maximum junction temperature will be exceeded.
- The maximum power dissipation for these devices must be derated at elevated temperatures and is dictated by  $T_{J(MAX)}$ ,  $\theta_{JA}$ , and the ambient temperature,  $T_A$ . The maximum available power dissipation at any temperature is  $P_D = (T_{J(MAX)} - T_A)/\theta_{JA}$  or the  $25^\circ$  C  $P_{D(MAX)}$ , whichever is less.
- $\mu$ A148, 248, 348 are capable of driving 100 pF capacitive load.  $\mu$ A149, 249, 349 are capable of driving 50 pF capacitive load.

# FAIRCHILD • $\mu$ A148/ $\mu$ A149 SERIES

**DC ELECTRICAL CHARACTERISTICS:**  $V_S = \pm 15$  V,  $T_A = 25^\circ\text{C}$  unless otherwise noted

CHARACTERISTIC	CONDITIONS	$\mu$ A348/ $\mu$ A349			UNITS
		MIN	TYP	MAX	
Input Offset Voltage	$R_s \leq 10$ k $\Omega$		1.0	6.0	mV
Input Offset Current			4	50	nA
Input Bias Current			30	200	nA
Input Resistance		0.8	2.5		M $\Omega$
Supply Current All Amplifiers	$V_{OUT} = \pm 10$ V, $R_L \geq 2$ k $\Omega$ $f = 1$ Hz to 20 kHz (Input Referred)		2.4	4.5	mA
Large Signal Voltage Gain		25	160		V/mV
Amplifier to Amplifier			-120		dB
Output Short Circuit Current			25		mA

The following specification apply for  $0^\circ\text{C} \leq T_A \leq 70^\circ\text{C}$

Input Offset Voltage	$R_s \leq 10$ k $\Omega$			7.5	mV
Input Offset Current				100	nA
Input Bias Current				400	nA
Large Signal Voltage Gain	$R_L \geq 2$ k $\Omega$ , $V_{OUT} = \pm 10$ V	15			V/mV
Output Voltage Swing	$R_L = 10$ k $\Omega$	$\pm 12$	$\pm 13$		V
	$R_L = 2$ k $\Omega$	$\pm 10$	$\pm 12$		V
Input Voltage Range		$\pm 12$			V
Common-Mode Rejection Ratio	$R_s \leq 10$ k $\Omega$	70	90		dB
Supply Voltage Rejection	$R_s \leq 10$ k $\Omega$	77	96		dB

**AC CHARACTERISTICS:**  $V_S = \pm 15$  V,  $T_A = 25^\circ\text{C}$  unless otherwise noted

Small Signal Bandwidth	$\mu$ A348		1.0		MHz
	$\mu$ A349		4.0		MHz
Phase Margin	$\mu$ A348 ( $A_v = 1$ )		60		degrees
	$\mu$ A349 ( $A_v = 5$ )		60		degrees
Slew Rate	$\mu$ A348 ( $A_v = 1$ )		0.5		V/ $\mu$ s
	$\mu$ A349 ( $A_v = 5$ )		2.0		V/ $\mu$ s

**NOTES:**

- Any of the amplifier outputs can be shorted to ground indefinitely; however, more than one should not be simultaneously shorted as the maximum junction temperature will be exceeded.
- The maximum power dissipation for these devices must be derated at elevated temperatures and is dictated by  $T_{J(MAX)}$ ,  $\theta_{JA}$ , and the ambient temperature,  $T_A$ . The maximum available power dissipation at any temperature is  $P_D = (T_{J(MAX)} - T_A)/\theta_{JA}$  or the  $25^\circ\text{C}$   $P_{D(MAX)}$ , whichever is less.
- $\mu$ A148, 248, 348 are capable of driving 100 pF capacitive load.  $\mu$ A149, 249, 349 are capable of driving 50 pF capacitive load.

¼ EQUIVALENT CIRCUIT

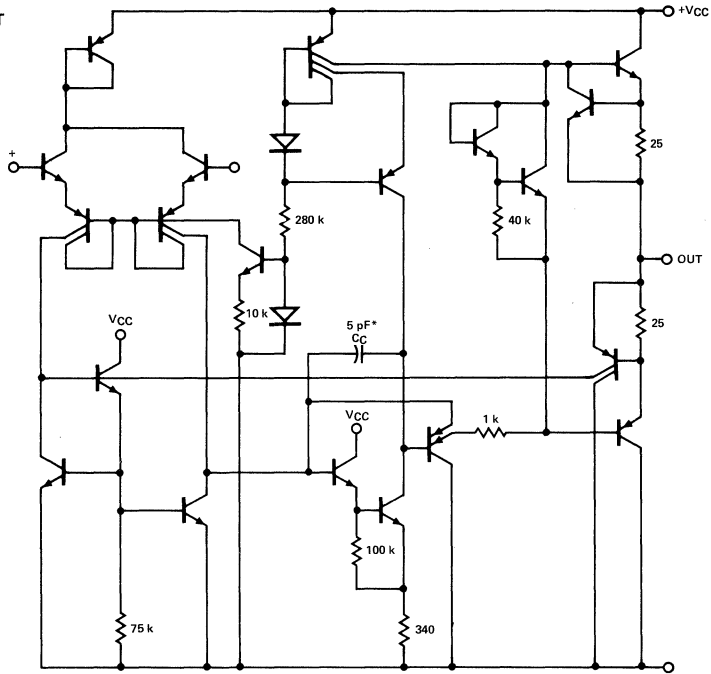

\* 1 pF on the  $\mu$ A149

TYPICAL PERFORMANCE CURVES

POSITIVE COMMON MODE INPUT VOLTAGE LIMIT AS A FUNCTION OF SUPPLY VOLTAGE

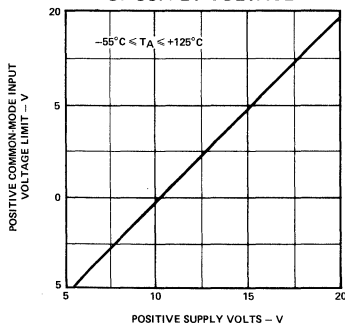

NEGATIVE COMMON MODE INPUT VOLTAGE LIMIT AS A FUNCTION OF SUPPLY VOLTAGE

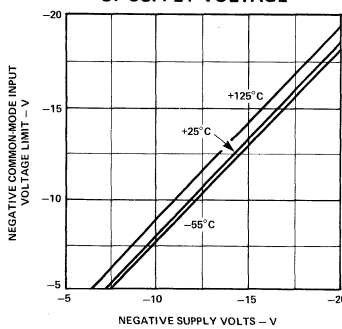

INPUT NOISE VOLTAGE AND NOISE CURRENT AS A FUNCTION OF FREQUENCY

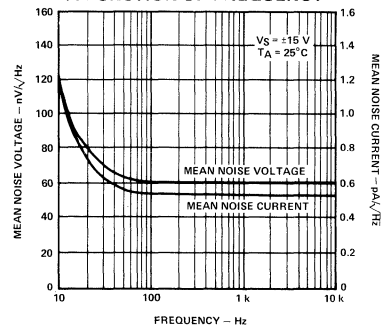

SLEW RATE AS A FUNCTION OF TEMPERATURE

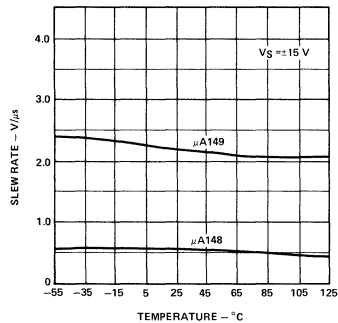

INVERTING LARGE SIGNAL PULSE RESPONSE ( $\mu$ A149)

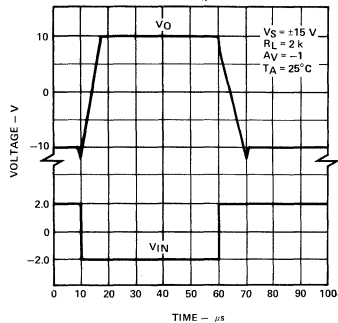

INVERTING LARGE SIGNAL PULSE RESPONSE ( $\mu$ A148)

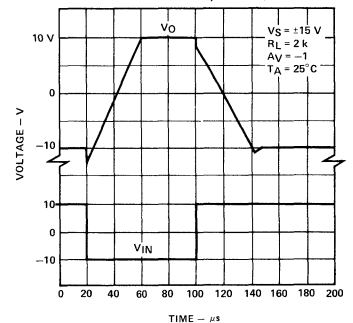

TYPICAL PERFORMANCE CURVES (Cont'd)

SUPPLY CURRENT AS A FUNCTION OF POWER SUPPLY VOLTAGE

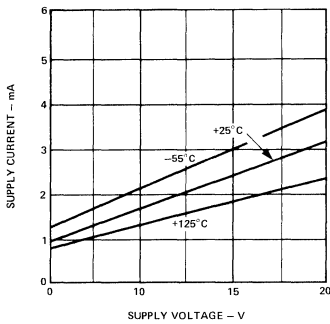

INPUT BIAS CURRENT AS A FUNCTION OF AMBIENT TEMPERATURE

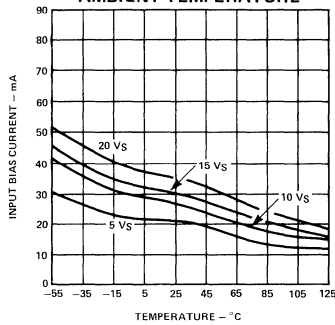

OUTPUT VOLTAGE SWING AS A FUNCTION OF SUPPLY VOLTAGE

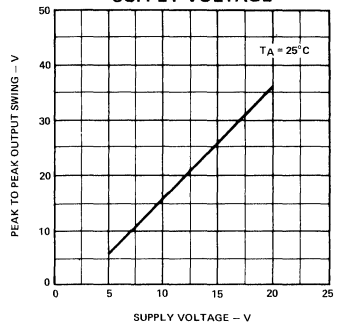

OUTPUT VOLTAGE AS A FUNCTION OF SOURCE CURRENT

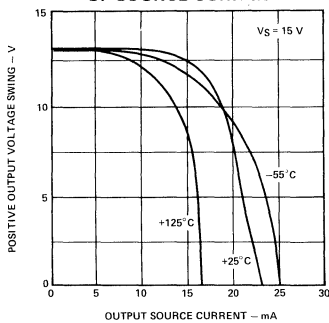

OUTPUT VOLTAGE AS A FUNCTION OF SINK CURRENT

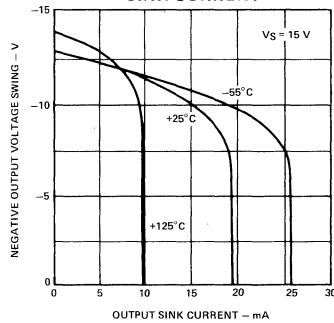

OUTPUT IMPEDANCE AS A FUNCTION OF FREQUENCY

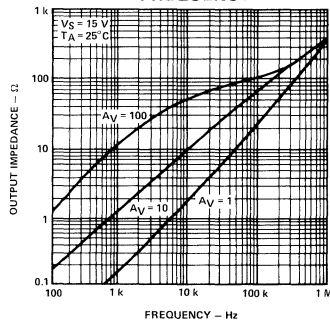

COMMON MODE REJECTION RATIO AS A FUNCTION OF FREQUENCY

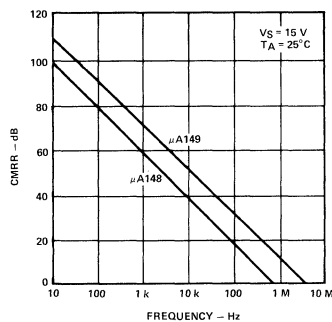

OPEN LOOP FREQUENCY RESPONSE AS A FUNCTION OF FREQUENCY

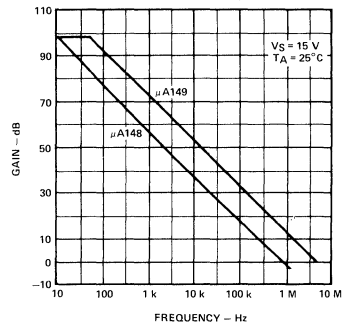

TYPICAL PERFORMANCE CURVES (Cont'd)

