

μA108A • μA208A • μA308A μA108 • μA208 • μA308

SUPER BETA OPERATIONAL AMPLIFIERS

FAIRCHILD LINEAR INTEGRATED CIRCUITS

GENERAL DESCRIPTION – The μA108 Super Beta Operational Amplifier series is constructed using the Fairchild Planar* epitaxial process. High input impedance, low noise, low input offsets, and temperature drift are made possible through use of super beta processing, making the device suitable for applications requiring high accuracy and low drift performance. The μA108A series is specially selected for extremely low offset voltage and drift, and high common mode rejection, giving superior performance in applications where offset nulling is undesirable. Increased slew rate without performance compromise is available through use of feedforward compensation techniques, maximizing performance in high speed sample-and-hold circuits and precision high speed summing amplifiers. The wide supply range and excellent supply voltage rejection assure maximum flexibility in voltage follower, summing, and general feedback applications.

- **GUARANTEED LOW INPUT OFFSET CHARACTERISTICS**
- **HIGH INPUT IMPEDANCE**
- **LOW OFFSET CURRENT**
- **LOW BIAS CURRENT**
- **OPERATION OVER WIDE SUPPLY RANGE**

ABSOLUTE MAXIMUM RATINGS

Supply Voltage	
μA108A, μA108, μA208A, μA208	±20 V
μA308A, μA308	±18 V
Internal Power Dissipation (Note 1)	
Metal Can	500 mW
DIP	600 mW
Flatpak	570 mW
Mini DIP	310 mW
Differential Input Current (Note 2)	±10 mA
Input Voltage (Note 3)	±15 V
Storage Temperature Range	-65°C to +150°C
Operating Temperature Range	
Military (μA108A, μA108)	-55°C to +125°C
Industrial (μA208A, μA208)	-25°C to +85°C
Commercial (μA308A, μA308)	0°C to +70°C
Pin Temperature (Soldering, 60 s)	300°C
Output Short-Circuit Duration (Note 4)	Indefinite

CONNECTION DIAGRAMS
8-PIN METAL CAN
(TOP VIEW)

PACKAGE OUTLINE 5S
PACKAGE CODE H

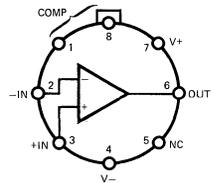

ORDER INFORMATION

TYPE	PART NO.
μA108A	μA108AHM
μA108	μA108HM
μA208A	μA208AHM
μA208	μA208HM
μA308A	μA308AHC
μA308	μA308HC

CONNECTION DIAGRAMS
8-PIN MINI DIP
(TOP VIEW)

PACKAGE OUTLINE 9T
PACKAGE CODE T

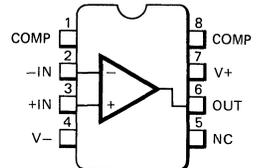

ORDER INFORMATION

TYPE	PART NO.
μA308A	μA308ATC
μA308	μA308TC

14-PIN DIP**
(TOP VIEW)
PACKAGE OUTLINE 6A
PACKAGE CODE D

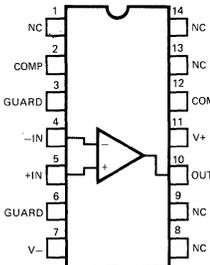

ORDER INFORMATION

TYPE	PART NO.
μA108A	μA108ADM
μA108	μA108DM
μA208A	μA208ADM
μA208	μ208DM
μA308A	μA308ADC
μA308	μA308DC

10-PIN FLATPAK**
(TOP VIEW)
PACKAGE OUTLINE 3F
PACKAGE CODE F

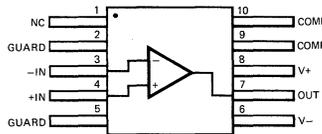

ORDER INFORMATION

TYPE	PART NO.
μA108A	μA108AFM
μA108	μA108FM
μA208A	μA208AFM
μA208	μA208FM

** Available on special order

EQUIVALENT CIRCUIT

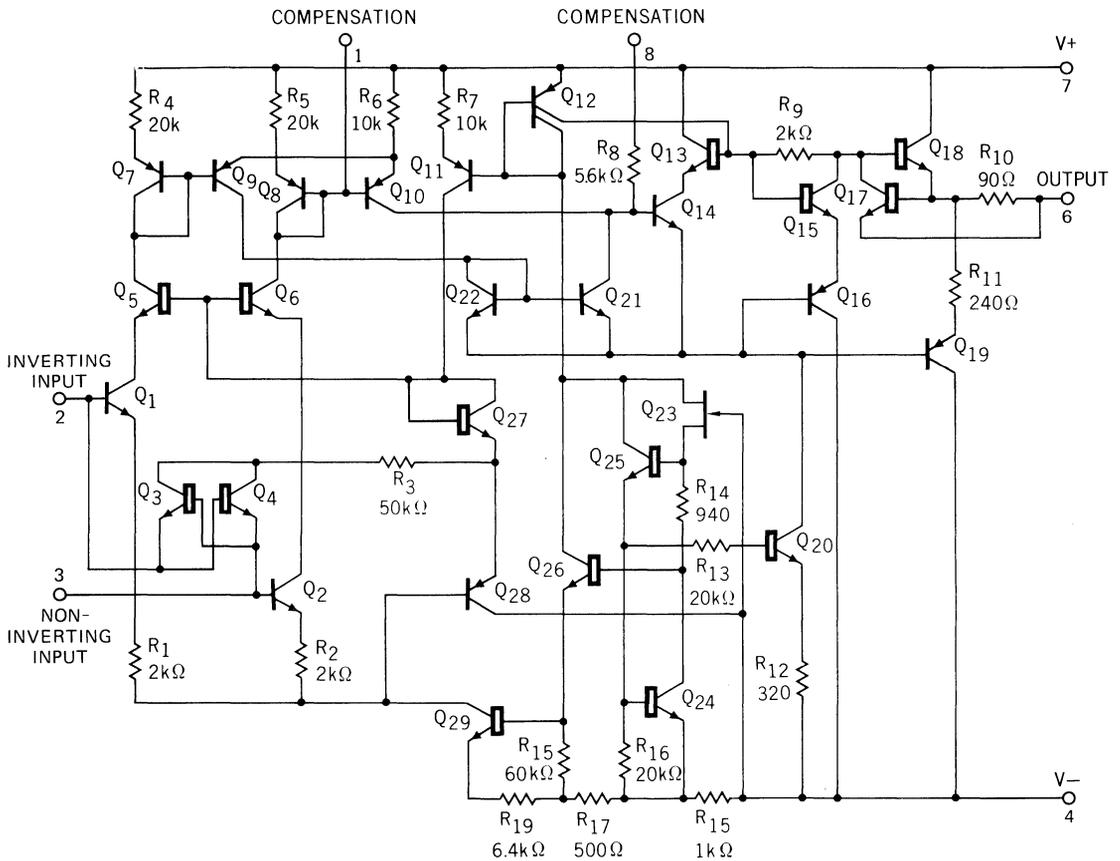

Pin numbers are for metal can only

FAIRCHILD • μ A108A • μ A208A • μ A308A • μ A108 • μ A208 • μ A308

μ A108A and μ A208A

ELECTRICAL CHARACTERISTICS: $\pm 5.0 \text{ V} \leq V_S \leq \pm 20 \text{ V}$, $T_A = 25^\circ\text{C}$, $C_C = 30 \text{ pF}$ unless otherwise specified.

CHARACTERISTICS	CONDITIONS	MIN	TYP	MAX	UNITS
Input Offset Voltage			0.3	0.5	mV
Input Offset Current			0.05	0.2	nA
Input Bias Current			0.8	2.0	nA
Input Resistance		30	70		M Ω
Supply Current	$V_S = \pm 15 \text{ V}$		0.3	0.6	mA
Large Signal Voltage Gain	$V_S = \pm 15 \text{ V}$, $R_L \geq 10 \text{ k}\Omega$, $V_{OUT} = \pm 10 \text{ V}$	80,000	300,000		V/V

The following specifications apply for $-55^\circ\text{C} \leq T_A \leq +125^\circ\text{C}$ (Note 5)

Input Offset Voltage				1.0	mV
Average Input Offset Voltage Drift			1.0	5.0	$\mu\text{V}/^\circ\text{C}$
Input Offset Current				0.4	nA
Average Input Offset Current Drift			0.5	2.5	$\text{pA}/^\circ\text{C}$
Input Bias Current			0.8	3.0	nA
Supply Current	$T_A = +125^\circ\text{C}$		0.15	0.4	mA
Input Voltage Range	$V_S = \pm 15 \text{ V}$	± 13.5			V
Common Mode Rejection Ratio		96	110		dB
Supply Voltage Rejection Ratio		96	110		dB
Large Signal Voltage Gain	$V_S = \pm 15 \text{ V}$, $R_L \geq 10 \text{ k}\Omega$, $V_{OUT} = \pm 10 \text{ V}$	40,000			V/V
Output Voltage Swing	$V_S = \pm 15 \text{ V}$, $R_L \geq 10 \text{ k}\Omega$	± 13	± 14		V

μ A308A

ELECTRICAL CHARACTERISTICS: $\pm 5.0 \text{ V} \leq V_S \leq \pm 15 \text{ V}$, $T_A = 25^\circ\text{C}$, $C_C = 30 \text{ pF}$ unless otherwise specified.

CHARACTERISTICS	CONDITIONS	MIN	TYP	MAX	UNITS
Input Offset Voltage			0.3	0.5	mV
Input Offset Current			0.2	1.0	nA
Input Bias Current			1.5	7.0	nA
Input Resistance		10	40		M Ω
Supply Current	$V_S = \pm 15 \text{ V}$		0.3	0.8	mA
Large Signal Voltage Gain	$V_S = \pm 15 \text{ V}$, $R_L \geq 10 \text{ k}\Omega$, $V_{OUT} = \pm 10 \text{ V}$	80,000	300,000		V/V

The following specifications apply for $0^\circ\text{C} \leq T_A \leq +70^\circ\text{C}$

Input Offset Voltage				0.73	mV
Average Input Offset Voltage Drift			1.0	5.0	$\mu\text{V}/^\circ\text{C}$
Input Offset Current				1.5	nA
Average Input Offset Current Drift			2.0	10	$\text{pA}/^\circ\text{C}$
Input Bias Current				10	nA
Input Voltage Range	$V_S = \pm 15 \text{ V}$	± 13.5			V
Common Mode Rejection Ratio		96	110		dB
Supply Voltage Rejection Ratio		96	110		dB
Large Signal Voltage Gain	$V_S = \pm 15 \text{ V}$, $R_L \geq 10 \text{ k}\Omega$, $V_{OUT} = \pm 10 \text{ V}$	60,000			V/V
Output Voltage Swing	$V_S = \pm 15 \text{ V}$, $R_L \geq 10 \text{ k}\Omega$	± 13	± 14		V

- Rating applies to ambient temperatures up to 70°C . Above 70°C ambient derate linearly at $6.3 \text{ mW}/^\circ\text{C}$ for metal can, $8.3 \text{ mW}/^\circ\text{C}$ for the DIP, $5.6 \text{ mW}/^\circ\text{C}$ for the mini DIP and $7.1 \text{ mW}/^\circ\text{C}$ for the flatpak.
- The inputs are shunted with back-to-back diodes for overvoltage protection. Therefore, excessive current will flow if a differential input voltage in excess of 1 V is applied between the inputs unless adequate limiting resistance is used.
- For supply voltages less than $\pm 15 \text{ V}$, the absolute maximum input voltage is equal to the supply voltage.
- Short circuit may be to either supply or ground. Rating applies to operation up to the maximum operating temperature range.
- For the μ A208A/208, all temperature specifications apply over $-25^\circ\text{C} \leq T_A \leq 85^\circ\text{C}$.

μ A108 and μ A208

ELECTRICAL CHARACTERISTICS: $\pm 5.0 \text{ V} \leq V_S \leq \pm 20 \text{ V}$, $T_A = 25^\circ\text{C}$, $C_C = 30 \text{ pF}$ unless otherwise specified.

CHARACTERISTICS	CONDITIONS	MIN	TYP	MAX	UNITS
Input Offset Voltage			0.7	2.0	mV
Input Offset Current			0.05	0.2	nA
Input Bias Current			0.8	2.0	nA
Input Resistance		30	70		M Ω
Supply Current	$V_S = \pm 15 \text{ V}$		0.3	0.6	mA
Large Signal Voltage Gain	$R_L \geq 10 \text{ k}\Omega$, $V_{OUT} = \pm 10 \text{ V}$ $V_S = \pm 15 \text{ V}$	50,000	300,000		V/V

The following specifications apply for $-55^\circ\text{C} \leq T_A \leq 125^\circ\text{C}$ (Note 5)

Input Offset Voltage				3.0	mV
Average Input Offset Voltage Drift			3.0	15	$\mu\text{V}/^\circ\text{C}$
Input Offset Current				0.4	nA
Average Input Offset Current Drift			0.5	2.5	$\text{pA}/^\circ\text{C}$
Input Bias Current				3.0	nA
Supply Current	$T_A = +125^\circ\text{C}$		0.15	0.4	mA
Input Voltage Range	$V_S = \pm 15 \text{ V}$	± 13.5			V
Common Mode Rejection Ratio		85	100		dB
Supply Voltage Rejection Ratio		80	96		dB
Large Signal Voltage Gain	$V_S = \pm 15 \text{ V}$, $R_L \geq 10 \text{ k}\Omega$, $V_{OUT} = \pm 10 \text{ V}$	25,000			V/V
Output Voltage Swing	$V_S = \pm 15 \text{ V}$, $R_L = 10 \text{ k}\Omega$	± 13	± 14		V

μ A308

ELECTRICAL CHARACTERISTICS: $\pm 5.0 \text{ V} \leq V_S \leq \pm 15 \text{ V}$, $T_A = 25^\circ\text{C}$, $C_C = 30 \text{ pF}$ unless otherwise specified.

CHARACTERISTICS	CONDITIONS	MIN	TYP	MAX	UNITS
Input Offset Voltage			2.0	7.5	mV
Input Offset Current			0.2	1.0	nA
Input Bias Current			1.5	7.0	nA
Input Resistance		10	40		M Ω
Supply Current	$V_S = \pm 15 \text{ V}$		0.3	0.8	mA
Large Signal Voltage Gain	$V_S = \pm 15 \text{ V}$, $R_L \geq 10 \text{ k}\Omega$, $V_{OUT} = \pm 10 \text{ V}$	25,000	300,000		V/V

The following specifications apply for $0^\circ\text{C} \leq T_A \leq +70^\circ\text{C}$

Input Offset Voltage				10	mV
Average Input Offset Voltage Drift			6.0	30	$\mu\text{V}/^\circ\text{C}$
Input Offset Current				1.5	nA
Average Input Offset Current Drift			2.0	10	$\text{pA}/^\circ\text{C}$
Input Bias Current				10	nA
Input Voltage Range	$V_S = \pm 15 \text{ V}$	± 13.5			V
Common Mode Rejection Ratio		80	100		dB
Supply Voltage Rejection Ratio		80	96		dB
Large Signal Voltage Gain	$V_S = \pm 15 \text{ V}$, $R_L \geq 10 \text{ k}\Omega$, $V_{OUT} = \pm 10 \text{ V}$	15,000			V/V
Output Voltage Swing	$V_S = \pm 15 \text{ V}$, $R_L = 10 \text{ k}\Omega$	± 13	± 14		V

5

TYPICAL PERFORMANCE CURVES FOR μ A108 SERIES

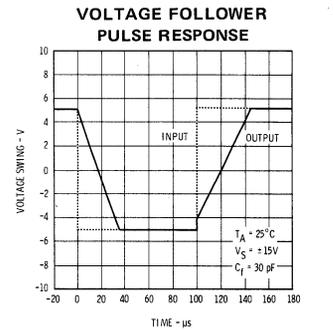
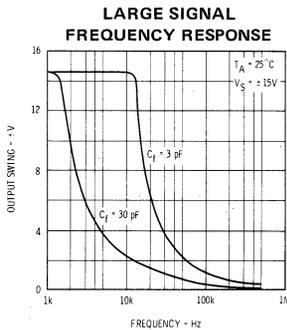
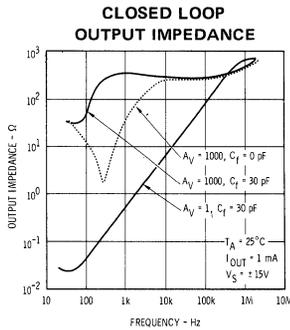
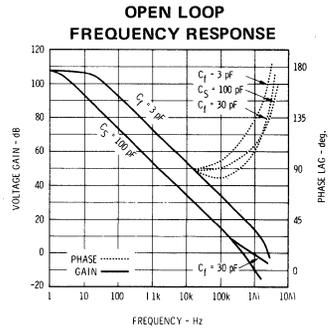
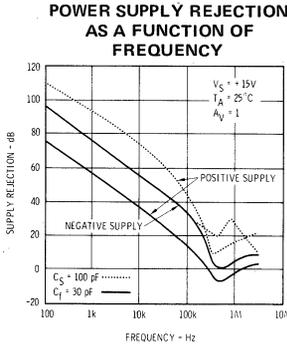
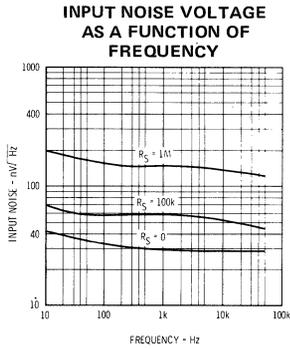

TYPICAL PERFORMANCE CURVES FOR μ A108A • μ A208A • μ A108 • μ A208 (Unless Otherwise Specified)

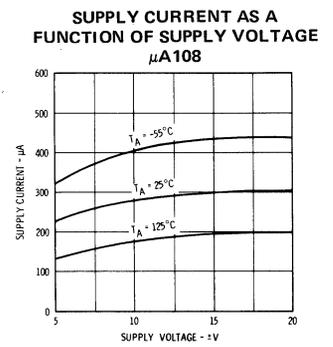
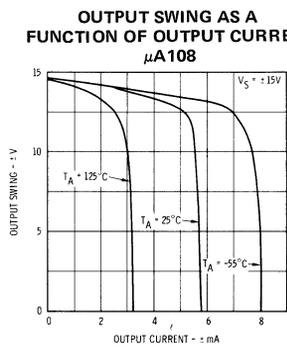
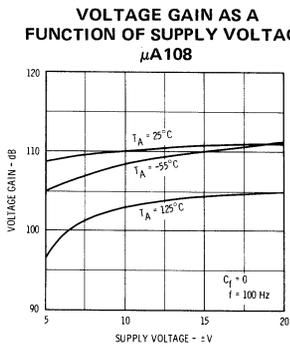
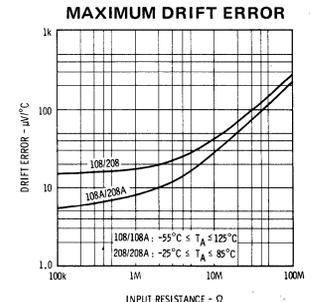
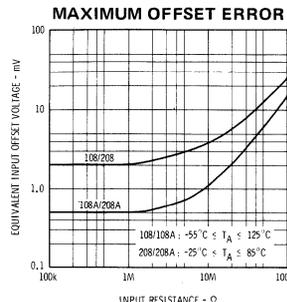
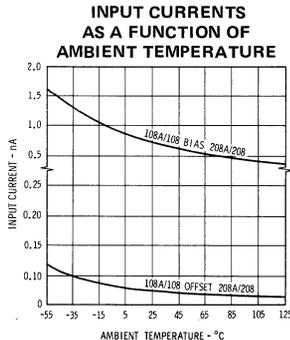

TYPICAL PERFORMANCE CURVES FOR μ A308A AND μ A308 (Unless Otherwise Specified)

INPUT CURRENT AS A FUNCTION OF AMBIENT TEMPERATURE

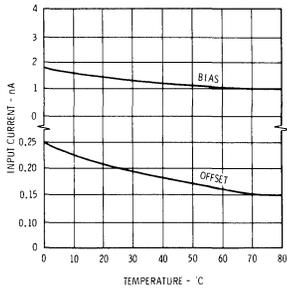

MAXIMUM OFFSET ERROR μ A308

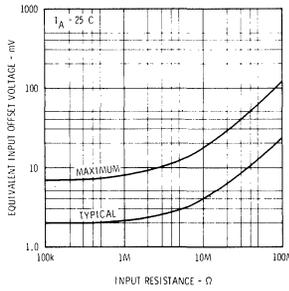

MAXIMUM DRIFT ERROR μ A308

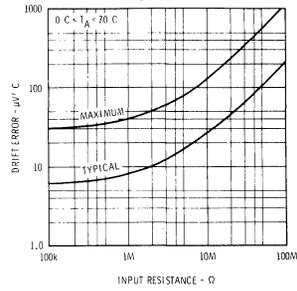

VOLTAGE GAIN AS A FUNCTION OF SUPPLY VOLTAGE

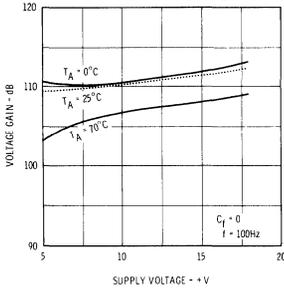

OUTPUT SWING AS A FUNCTION OF OUTPUT CURRENT

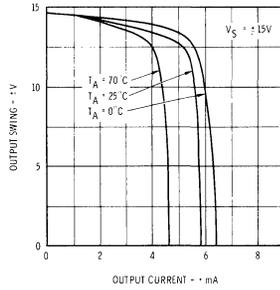

SUPPLY CURRENT AS A FUNCTION OF SUPPLY VOLTAGE

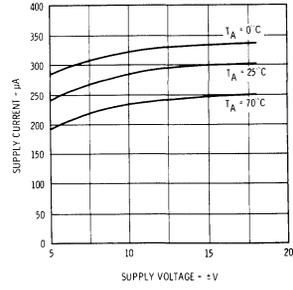

STANDARD COMPENSATION CIRCUITS

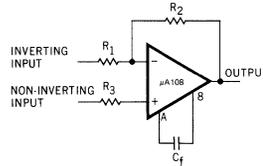
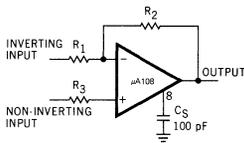

$$C_f \geq 30 \left(\frac{1}{1 + \frac{R_2}{R_1}} \right)$$

FEEDFORWARD COMPENSATION HIGHER SLEW RATES AND WIDER BANDWIDTH

STANDARD FEEDFORWARD

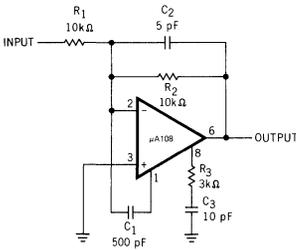

OPEN LOOP VOLTAGE GAIN

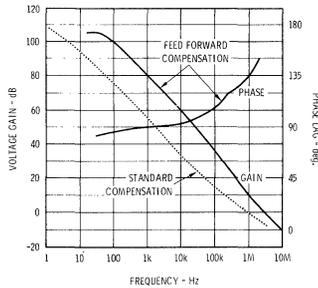

FEEDFORWARD COMPENSATION FOR DECOUPLING LOAD CAPACITANCE

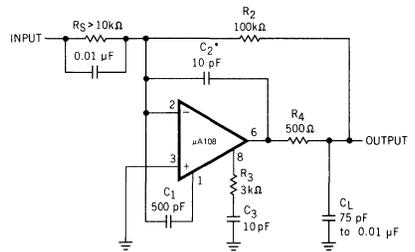

$$*C_2 > 5 \times 10^5 \frac{\text{pF}}{R_2}$$

GUARDING

Extra care must be taken in the assembly of printed circuit boards to take full advantage of the low input currents of the μ A108 amplifier. Boards must be thoroughly cleaned with TCE or alcohol and blown dry with compressed air. After cleaning, the boards should be coated with epoxy or silicone rubber to prevent contamination.

Even with properly cleaned and coated boards, leakage currents may cause trouble at 125°C, particularly since the input pins are adjacent to pins that are at supply potentials. This leakage can be significantly reduced by using guarding to lower the voltage difference between the inputs and adjacent metal runs. Input guarding of the 8-pin TO-99 package is accomplished by using a 10-pin pin circle, with the leads of the device formed so that the holes adjacent to the inputs are empty when it is inserted in the board. The guard, which is a conductive ring surrounding the inputs, is connected to a low impedance point that is at approximately the same voltage as the inputs. Leakage currents from high voltage pins are then absorbed by the guard.

The pin configuration of the dual in-line package is designed to facilitate guarding, since the pins adjacent to the inputs are not used (this is different from the standard μ A741 and μ A101A pin configuration).

CONNECTION OF INPUT GUARDS

INVERTING AMPLIFIER

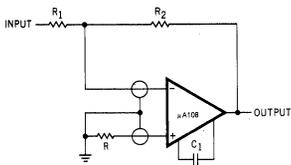

$$R = \frac{R_1 R_2}{R_1 + R_2}$$

FOLLOWER

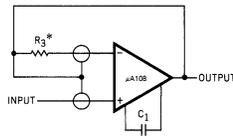

* Use to compensate for large source resistances.

NON-INVERTING AMPLIFIER

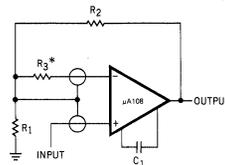

NOTE: $\frac{R_1 R_2}{R_1 + R_2}$ Must be low impedance

BOARD LAYOUT FOR INPUT GUARDING WITH TO-99 PACKAGE (BOTTOM VIEW)

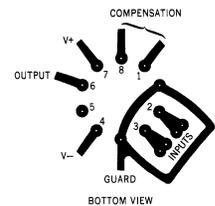

TYPICAL APPLICATIONS

FAST[†] SUMMING AMPLIFIER WITH LOW INPUT CURRENT

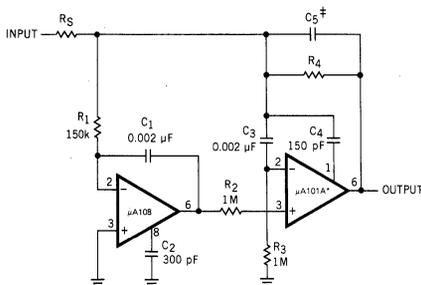

*In addition to increasing speed, the μ A101A raises high and low frequency gain, increases output drive capability and eliminates thermal feedback.

† Power Bandwidth: 250 kHz
Small Signal Bandwidth: 3.5 MHz
Slew Rate: 10 V/μs

$$\ddagger C_5 = \frac{6 \times 10^{-8}}{R_1}$$

SAMPLE AND HOLD

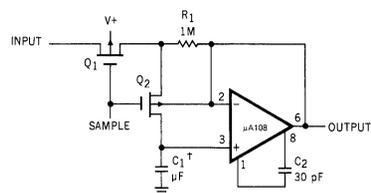

* Worst case drift less than 2.5 mV/s

† Teflon, Polyethylene or Polycarbonate Dielectric Capacitor