

# μA555

## SINGLE TIMING CIRCUIT

### FAIRCHILD LINEAR INTEGRATED CIRCUIT

**GENERAL DESCRIPTION** — The μA555 Timing Circuit is a very stable controller for producing accurate time delays or oscillations. In the time delay mode, the delay time is precisely controlled by one external resistor and one capacitor; in the oscillator mode, the frequency and duty cycle are both accurately controlled with two external resistors and one capacitor. By applying a trigger signal, the timing cycle is started and an internal flip-flop is set, immunizing the circuit from any further trigger signals. To interrupt the timing cycle a reset signal is applied ending the time-out.

The output, which is capable of sinking or sourcing 200 mA, is compatible with TTL circuits and can drive relays or indicator lamps.

- MICROSECONDS THROUGH HOURS TIMING CONTROL
- ASTABLE OR MONOSTABLE OPERATING MODES
- ADJUSTABLE DUTY CYCLE
- 200 mA SINK OR SOURCE OUTPUT CURRENT CAPABILITY
- TTL OUTPUT DRIVE CAPABILITY
- TEMPERATURE STABILITY OF 0.005% PER °C
- NORMALLY ON OR NORMALLY OFF OUTPUT
- DIRECT REPLACEMENT FOR SE555/NE555

#### ABSOLUTE MAXIMUM RATINGS

|   |                 |
|---|-----------------|
| Supply Voltage                          | +18 V           |
| Power Dissipation (Note 1)              | 600 mW          |
| Operating Temperature Ranges            |                 |
| μA555TC/HC                              | 0°C to +70°C    |
| μA555HM                                 | -55°C to +125°C |
| Storage Temperature Range               | -65°C to +150°C |
| Pin Temperature                         |                 |
| Plastic Mini DIP (9T) (Soldering, 10 s) | 260°C           |
| Metal Can (5T) (Soldering, 60 s)        | 300°C           |

#### BLOCK DIAGRAM

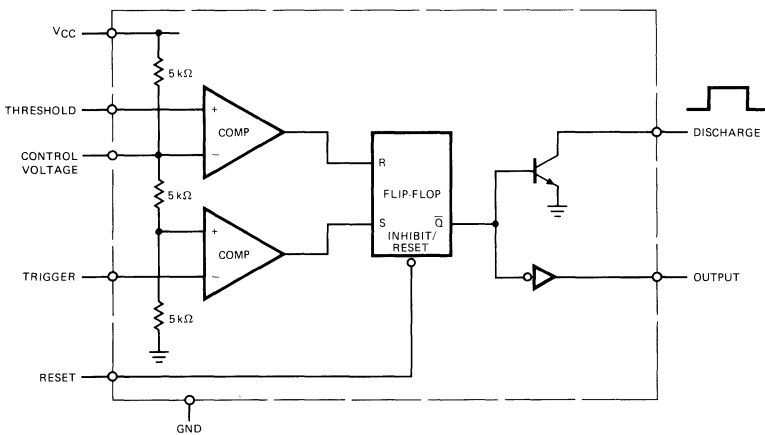

#### CONNECTION DIAGRAMS

##### 8-PIN MINI DIP (TOP VIEW)

##### PACKAGE OUTLINE 9T

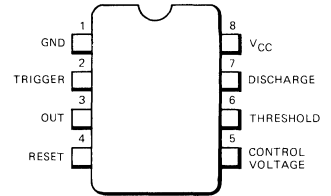

| ORDER INFORMATION |          |
|-------------------|----------|
| TYPE              | PART NO. |
| μA555             | μA555TC  |

| 8-PIN TO-100<br>(TOP VIEW) |  |
|----------------------------|--|
| PACKAGE OUTLINE 5T         |  |

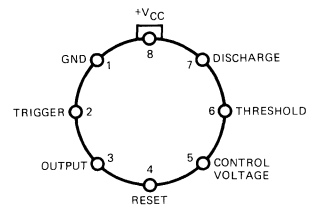

| ORDER INFORMATION |          |
|-------------------|----------|
| TYPE              | PART NO. |
| μA555             | μA555HM  |
| μA555             | μA555HC  |

# FAIRCHILD • $\mu$ A555

**ELECTRICAL CHARACTERISTICS:**  $T_A = 25^\circ\text{C}$ ,  $V_{CC} = +5.0\text{ V}$  to  $+15\text{ V}$ , unless otherwise specified

| CHARACTERISTICS            | TEST CONDITIONS  | $\mu$ A555HM |      |      | $\mu$ A555TC/HC |      |      | UNITS                 |
|----------------------------|--|--------------|------|------|-----------------|------|------|-----------------------|
|                            |  | MIN          | TYP  | MAX  | MIN             | TYP  | MAX  |                       |
| Supply Voltage             |  | 4.5          |      | 18   | 4.5             |      | 16   | V                     |
| Supply Current             | $V_{CC} = 5.0\text{ V}$ , $R_L = \infty$   |              | 3.0  | 5.0  |                 | 3.0  | 6.0  | mA                    |
|                            | $V_{CC} = 15\text{ V}$ , $R_L = \infty$<br>LOW State (Note 1)                                  |              | 10   | 12   |                 | 10   | 15   | mA                    |
| Timing Error               |  |              |      |      |                 |      |      |                       |
| Initial Accuracy           | $R_A, R_B = 1\text{ k}\Omega$ to $100\text{ k}\Omega$<br>$C = 0.1\text{ }\mu\text{F}$ (Note 2) |              | 0.5  | 2.0  |                 | 1.0  |      | %                     |
| Drift with Temperature     |  |              | 30   | 100  |                 | 50   |      | ppm/ $^\circ\text{C}$ |
| Drift with Supply Voltage  |  |              | 0.05 | 0.2  |                 | 0.1  |      | %V                    |
| Threshold Voltage          |  |              | 2/3  |      |                 | 2/3  |      | $\times V_{CC}$       |
| Trigger Voltage            | $V_{CC} = 15\text{ V}$   | 4.8          | 5.0  | 5.2  |                 | 5.0  |      | V                     |
|                            | $V_{CC} = 5.0\text{ V}$  | 1.45         | 1.67 | 1.9  |                 | 1.67 |      | V                     |
| Trigger Current            |  |              | 0.5  |      |                 | 0.5  |      | $\mu\text{A}$         |
| Reset Voltage              |  | 0.4          | 0.7  | 1.0  | 0.4             | 0.7  | 1.0  | V                     |
| Reset Current              |  |              | 0.1  |      |                 | 0.1  |      | mA                    |
| Threshold Current          | Note 3   |              | 0.1  | 0.25 |                 | 0.1  | 0.25 | $\mu\text{A}$         |
| Control Voltage Level      | $V_{CC} = 15\text{ V}$   | 9.6          | 10   | 10.4 | 9.0             | 10   | 11   | V                     |
|                            | $V_{CC} = 5.0\text{ V}$  | 2.9          | 3.33 | 3.8  | 2.6             | 3.33 | 4.0  | V                     |
| Output Voltage Drop (LOW)  | $V_{CC} = 15\text{ V}$<br>$I_{\text{SINK}} = 10\text{ mA}$                                     |              | 0.1  | 0.15 |                 | 0.1  | 0.25 | V                     |
|                            | $I_{\text{SINK}} = 50\text{ mA}$   |              | 0.4  | 0.5  |                 | 0.4  | 0.75 | V                     |
|                            | $I_{\text{SINK}} = 100\text{ mA}$  |              | 2.0  | 2.2  |                 | 2.0  | 2.5  | V                     |
|                            | $I_{\text{SINK}} = 200\text{ mA}$  |              | 2.5  |      |                 | 2.5  |      | V                     |
|                            | $V_{CC} = 5.0\text{ V}$<br>$I_{\text{SINK}} = 8.0\text{ mA}$                                   |              |      | 0.1  | 0.25            |      |      | V                     |
|                            | $I_{\text{SINK}} = 5.0\text{ mA}$  |              |      |      |                 | 0.25 | 0.35 | V                     |
| Output Voltage Drop (HIGH) | $I_{\text{SOURCE}} = 200\text{ mA}$<br>$V_{CC} = 15\text{ V}$                                  |              | 12.5 |      |                 | 12.5 |      | V                     |
|                            | $I_{\text{SOURCE}} = 100\text{ mA}$<br>$V_{CC} = 15\text{ V}$                                  | 13           | 13.3 |      | 12.75           | 13.3 |      | V                     |
|                            | $V_{CC} = 5.0\text{ V}$  | 3.0          | 3.3  |      | 2.75            | 3.3  |      | V                     |
| Rise Time of Output        |  |              | 100  |      |                 | 100  |      | ns                    |
| Fall Time of Output        |  |              | 100  |      |                 | 100  |      | ns                    |

**NOTES:**

1. Supply Current is typically 1.0 mA less when output is HIGH.
2. Tested at  $V_{CC} = 5.0\text{ V}$  and  $V_{CC} = 15\text{ V}$ .
3. This will determine the maximum value of  $R_A + R_B$ . For 15 V operation, the max total  $R = 20\text{ M}\Omega$ .
4. For operating at elevated temperatures the device must be derated based on a  $+125^\circ\text{C}$  maximum junction temperature and a thermal resistance of  $+45^\circ\text{C/W}$  junction to case for TO-5 and  $+150^\circ\text{C/W}$  junction to ambient for both packages.

TYPICAL PERFORMANCE CURVES

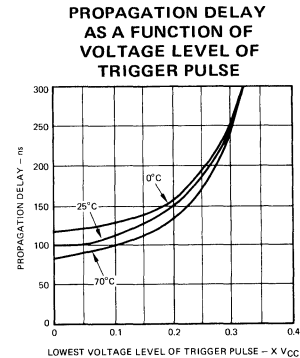
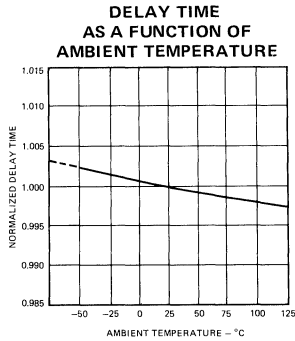
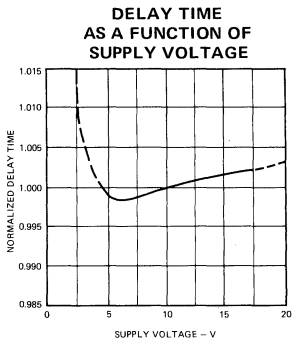
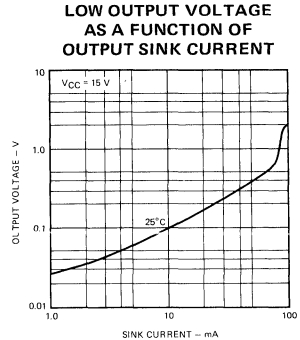
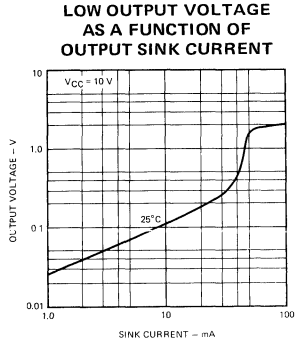
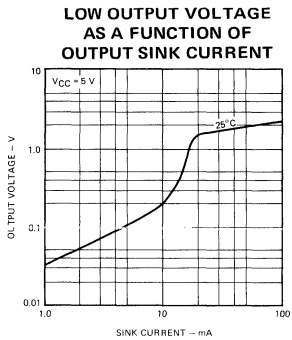
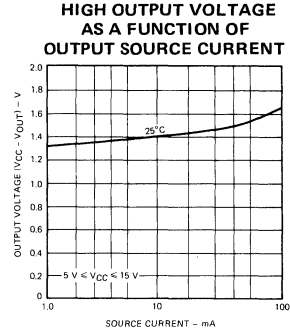
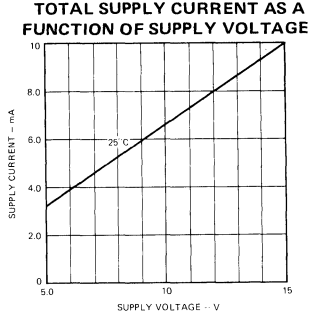
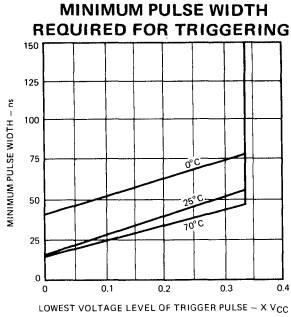

7

EQUIVALENT CIRCUIT

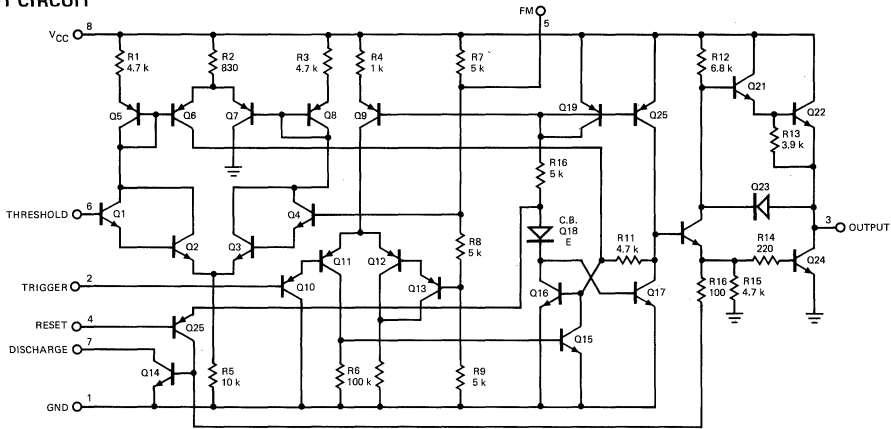

TYPICAL APPLICATIONS

MONOSTABLE OPERATION

In the monostable mode, the timer functions as a one-shot. Referring to Figure 1 the external capacitor is initially held discharged by a transistor inside the timer.

When a negative trigger pulse is applied to lead 2, the flip-flop is set, releasing the short circuit across the external capacitor and drives the output HIGH. The voltage across the capacitor, increases exponentially with the time constant  $\tau = R1C1$ . When the voltage across the capacitor equals  $2/3 V_{CC}$ , the comparator resets the flip-flop which then discharges the capacitor rapidly and drives the output to its LOW state. Figure 2 shows the actual waveforms generated in this mode of operation.

The circuit triggers on a negative-going input signal when the level reaches  $1/3 V_{CC}$ . Once triggered, the circuit remains in this state

until the set time has elapsed, even if it is triggered again during this interval. The duration of the output HIGH state is given by  $t = 1.1 R1C1$  and is easily determined by Figure 3. Notice that since the charge rate and the threshold level of the comparator are both directly proportional to supply voltage, the timing interval is independent of supply. Applying a negative pulse simultaneously to the Reset terminal (lead 4) and the Trigger terminal (lead 2) during the timing cycle discharges the external capacitor and causes the cycle to start over. The timing cycle now starts on the positive edge of the reset pulse. During the time the reset pulse is applied, the output is driven to its LOW state.

When Reset is not used, it should be tied high to avoid any possibility of false triggering.

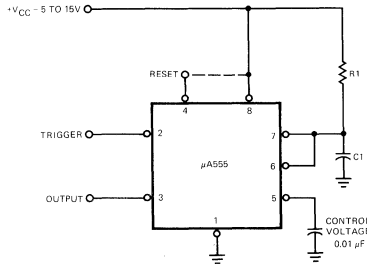
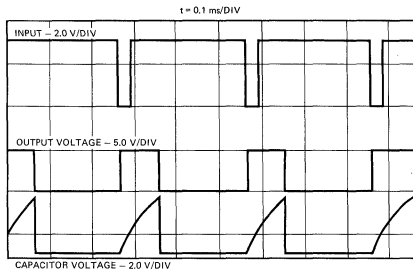

Fig. 1



$R1 = 9.1 \text{ k}\Omega$ ,  $C1 = 0.01 \text{ }\mu\text{F}$ ,  $R_L = 1.0 \text{ k}\Omega$

Fig. 2

TIME DELAY AS A FUNCTION OF R1 AND C1

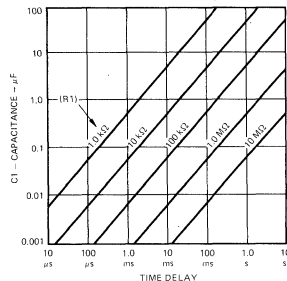

Fig. 3

TYPICAL APPLICATIONS (Cont'd)

**ASTABLE OPERATION**

When the circuit is connected as shown in Figure 4 (leads 2 and 6 connected) it triggers itself and free runs as a multivibrator. The external capacitor charges through R1 and R2 and discharges through R2 only. Thus the duty cycle may be precisely set by the ratio of these two resistors.

In the astable mode of operation, C1 charges and discharges between  $1/3 V_{CC}$  and  $2/3 V_{CC}$ . As in the triggered mode, the charge and discharge times and therefore frequency are independent of the supply voltage.

Figure 5 shows actual waveforms generated in this mode of operation.

The charge time (output HIGH) is given by:

$$t_1 = 0.693 (R_1 + R_2) C_1$$

and the discharge time (output LOW) by:

$$t_2 = 0.693 (R_2) C_1$$

Thus the total period T is given by:

$$T = t_1 + t_2 = 0.693 (R_1 + 2R_2) C_1$$

The frequency of oscillation is then:

$$f = \frac{1}{T} = \frac{1.44}{(R_1 + 2R_2) C_1}$$

and may be easily found by Figure 6.

The duty cycle is given by:

$$D = \frac{R_2}{R_1 + 2R_2}$$

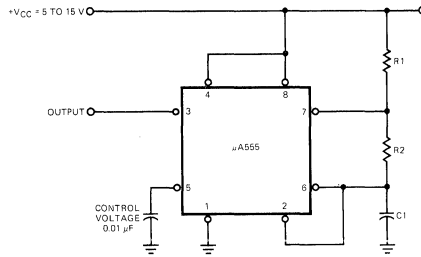

Fig. 4

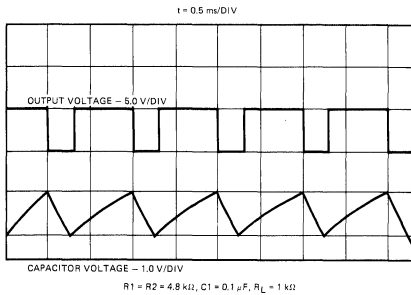

Fig. 5

**FREE RUNNING FREQUENCY AS A FUNCTION OF R1, R2 AND C1**

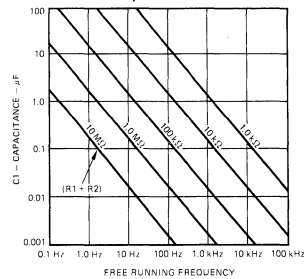

Fig. 6