

μA78G • μA79G 4-Terminal Adjustable Voltage Regulators

Linear Division Voltage Regulators

Description

The μA78G and μA79G are 4-terminal adjustable voltage regulators. They are designed to deliver continuous load currents of up to 1.0 A with a maximum input voltage of +40 V for the positive regulator μA78G and -40 V for the negative regulator μA79G. Output current capability can be increased to greater than 1.0 A through use of one or more external transistors. The output voltage range of the μA78G positive voltage regulator is +5 V to +30 V and the output voltage range of the negative μA79G is -30 V to -2.2 V. For systems requiring both a positive and negative, the μA78G and μA79G are excellent for use as a dual tracking regulator with appropriate external circuitry. These 4-terminal voltage regulators are constructed using the Fairchild Planar process.

- Output Current In Excess Of 1 A
- μA78G Positive Output +5 To +30 V
- μA79G Negative Output -30 To -2.2 V
- Internal Thermal Overload Protection
- Internal Short Circuit Protection
- Output Transistor Safe-Area Protection

Absolute Maximum Ratings

Storage Temperature Range	-65°C to +150°C
Operating Junction Temperature Range	0°C to 150°C
Lead Temperature (soldering, 10 s)	265°C
Power Dissipation	Internally Limited
Input Voltage	
μA78G	+40 V
μA79G	-40 V
Control Lead Voltage	
μA78G	$0 \text{ V} \leq V_+ \leq V_O$
μA79G	$V_{O-} \leq V_- \leq 0 \text{ V}$

Connection Diagram 4-Lead TO-202 Package (Top View)

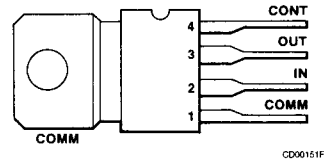

Heat sink tabs connected to common through device substrate.

Order Information

Device Code	Package Code	Package Description
μA78GU1C	8Z	Power Watt

Connection Diagram 4-Lead TO-202 Package (Top View)

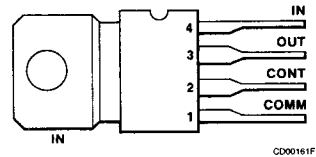

Heat sink tabs connected to input through device substrate. Not recommended for direct electrical connection.

Order Information

Device Code	Package Code	Package Description
μA79GU1C	8Z	Power Watt

μA78G Equivalent Circuit

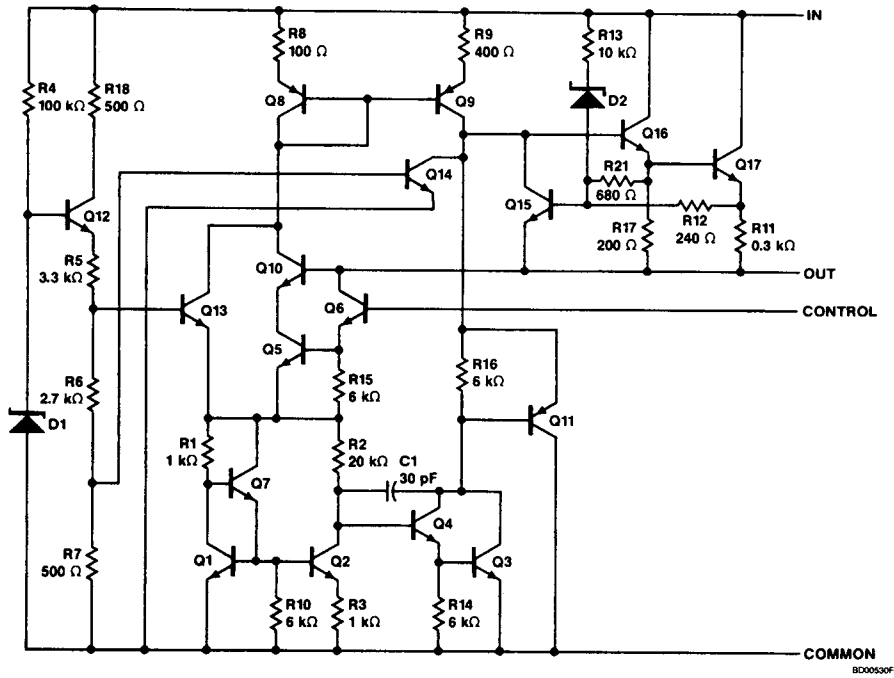

μA79G Equivalent Circuit (Note 1)

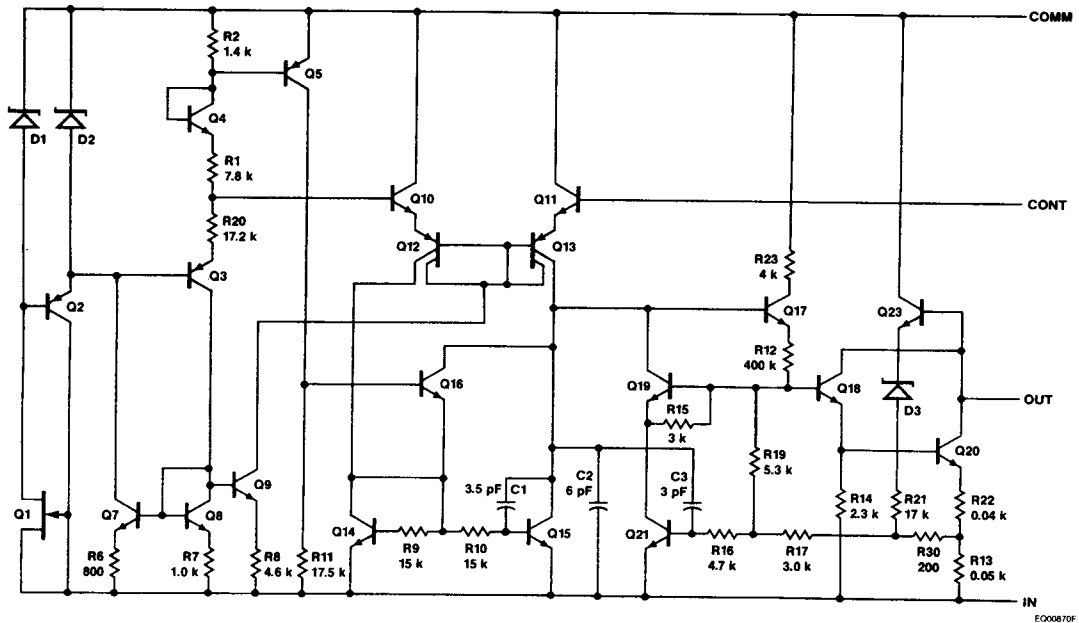

Note

1. All Resistor values in ohms

μA78G

Electrical Characteristics 0°C ≤ T_A ≤ 125°C, C_I = 0.33 μF, C_O = 0.1 μF, V_I = 10 V, I_O = 500 mA,
Test Circuit 1, unless otherwise specified.

Symbol	Characteristic	Condition ^{1,3}	Min	Typ	Max	Unit
V _{IR}	Input Voltage Range	T _J = 25°C	7.5		40	V
V _{OR}	Output Voltage Range	V _I = V _O + 5.0 V	5.0		30	V
V _O	Output Voltage Tolerance	V _O + 3.0 V ≤ V _I ≤ V _O + 15 V, 5.0 mA ≤ I _O ≤ 1.0 A P _D ≤ 15 W, V _{I max} = 38 V	T _J = 25°C		4.0	% V _O
					5.0	
V _{O LINE}	Line Regulation	T _J = 25°C, V _O ≤ 10 V (V _O + 2.5 V) ≤ V _I ≤ (V _O + 20 V)			1.0	% V _O
V _{O LOAD}	Load Regulation	T _J = 25°C, V _I = V _O + 5.0 V	250 mA ≤ I _O ≤ 750 mA		1.0	% V _O
			5.0 mA ≤ I _O ≤ 1.5 A		2.0	
I _C	Control Lead Current	T _J = 25°C		1.0	5.0	μA
					8.0	
I _Q	Quiescent Current	T _J = 25°C		3.2	6.0	mA
					7.0	
ΔV _I /ΔV _O	Ripple Rejection	8.0 V ≤ V _I ≤ 18 V, f = 2400 Hz V _O = 5.0 V, I _C = 350 mA	68	78		dB
N _O	Noise	T _J = 25°C, 10 Hz < f < 100 kHz, V _O = 5.0 V, I _O = 5.0 mA		8.0	40	μV/V _O
V _{DO}	Dropout Voltage ²			2.0	2.5	V
I _{OS}	Output Short Circuit Current	T _J = 25°C, V _I = 30 V		.750	1.2	A
I _{pk}	Peak Output Current	T _J = 25°C	1.3	2.2	3.3	A
ΔV _O /ΔT	Average Temperature Coefficient of Output Voltage	V _O = 5.0 V, I _O = 5.0 mA	T _A = -55°C to +25°C		0.4	mV/°C/ V _O
			T _A = 25°C to 125°C		0.3	
V _C	Control Lead Voltage (Reference)	T _J = 25°C		4.8	5.0	V
				4.75	5.25	

Notes

- V_O is defined for the μA78G as $V_O = \frac{R1 + R2}{R2}(5.0)$;
the μA79G as $V_O = \frac{R1 + R2}{R2}(-2.23)$.
- Dropout Voltage is defined as that input/output voltage differential which causes the output voltage to decrease by 5% of its initial value.
- All characteristics except noise voltage and ripple rejection ratio are measured using pulse techniques (t_w ≤ 10 ms, duty cycle ≤ 5%). Output voltage changes due to changes in internal temperature must be taken into account separately.

6

μA78G • μA79G

μA79G

Electrical Characteristics $0^{\circ}\text{C} \leq T_A \leq 125^{\circ}\text{C}$ for μA79G, $V_I = -10\text{ V}$, $I_O = 500\text{ mA}$, $C_I = 2.0\ \mu\text{F}$, $C_O = 1.0\ \mu\text{F}$, Test Circuit 2 and Note 3, unless otherwise specified.

Symbol	Characteristic	Condition ¹		Min	Typ	Max	Unit
V_{IR}	Input Voltage Range	$T_J = 25^{\circ}\text{C}$		-40		-7.0	V
V_{OR}	Nominal Output Voltage Range	$V_I = V_O - 5.0\text{ V}$		-30		-2.23	V
V_O	Output Voltage Tolerance	$V_O - 15\text{ V} \leq V_I \leq V_O - 3.0\text{ V}$ $5.0\text{ mA} \leq I_O \leq 1.0\text{ A}$ $P_D \leq 15\text{ W}$, $V_{I\text{ Max}} = -3.8\text{ V}$	$T_J = 25^{\circ}\text{C}$			4.0	% V_O
						5.0	
$V_{O\text{ LINE}}$	Line Regulation	$T_J = 25^{\circ}\text{C}$, $V_O \geq -10\text{ V}$ $(V_O - 20\text{ V}) \leq V_I \leq (V_O - 2.5\text{ V})$				1.0	% V_O
$V_{O\text{ LOAD}}$	Load Regulation	$T_J = 25^{\circ}\text{C}$, $V_I = V_O - 5.0\text{ V}$	$250\text{ mA} \leq I_O \leq 750\text{ mA}$			1.0	% V_O
			$5.0\text{ mA} \leq I_O \leq 1.5\text{ A}$			2.0	
I_C	Control Lead Current	$T_J = 25^{\circ}\text{C}$			0.4	2.0	μA
						3.0	
I_Q	Quiescent Current	$T_J = 25^{\circ}\text{C}$			0.5	2.5	mA
						3.0	
$\Delta V_I / \Delta V_O$	Ripple Rejection	$V_O = -8.0\text{ V}$, $V_I = -13\text{ V}$, $f = 2400\text{ Hz}$, $I_C = 350\text{ mA}$		50	60		dB
N_O	Noise	$T_J = 25^{\circ}\text{C}$, $10\text{ Hz} \leq f \leq 100\text{ kHz}$, $V_O = -8.0\text{ V}$, $I_O = 5.0\text{ mA}$			25	80	μV/ V_O
V_{DO}	Dropout Voltage ²				1.1	2.3	V
I_{OS}	Output Short Circuit Current	$T_J = 25^{\circ}\text{C}$, $V_I = -30\text{ V}$			0.25	1.2	A
I_{pk}	Peak Output Current	$T_J = 25^{\circ}\text{C}$		1.3	2.1	3.3	A
$\Delta V_O / \Delta T$	Average Temperature Coefficient of Output Voltage	$V_O = -5.0\text{ V}$, $I_O = 5.0\text{ mA}$	$T_A = -55^{\circ}\text{C}$ to $+25^{\circ}\text{C}$			0.3	mV/ $^{\circ}\text{C}$ / V_O
			$T_A = 25^{\circ}\text{C}$ to 125°C			0.3	
V_C	Control Lead Voltage (Reference)	$T_J = 25^{\circ}\text{C}$		-2.32	-2.23	-2.14	V
				-2.35		-2.11	

Notes

1. V_O is defined for the μA78G as $V_O = \frac{R1 + R2}{R2}(-5.0)$;
the μA79G as $V_O = \frac{R1 + R2}{R2}(-2.23)$.

2. Dropout voltage is defined as that input/output voltage differential which causes the output voltage to decrease by 5% of its initial value.

3. The convention for negative regulators is the algebraic value, thus -15 V is less than -10 V.

4. All characteristics except noise voltage and ripple rejection ratio are measured using pulse techniques ($t_W \leq 10\text{ ms}$, duty cycle $\leq 5\%$). Output voltage changes due to changes in internal temperature must be taken into account separately.

Typical Performance Curves for μA78G

Peak Output Current vs Input/Output Differential Voltage

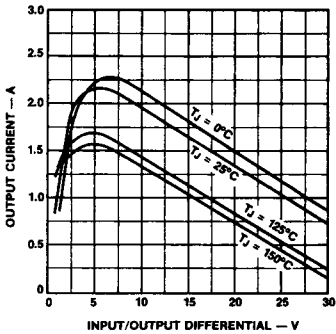

PC11790F

Quiescent Current vs Input Voltage

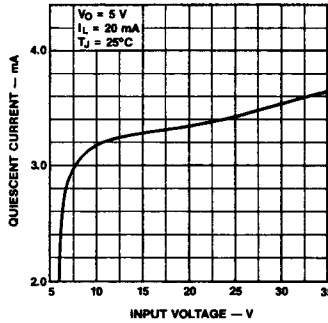

PC11800F

Control Current vs Junction Temperature

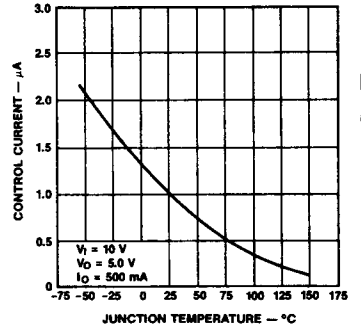

PC11810F

Differential Control Voltage vs Input Voltage

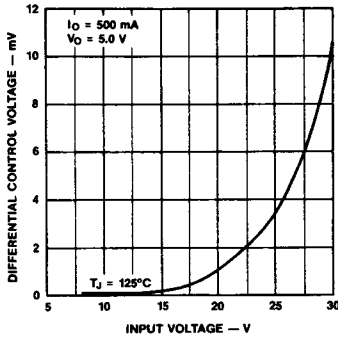

PC11820F

Differential Control Voltage vs Output Current

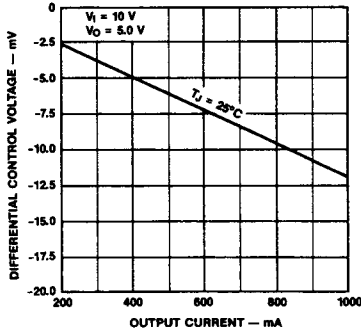

PC11830F

Ripple Rejection vs Output Voltage

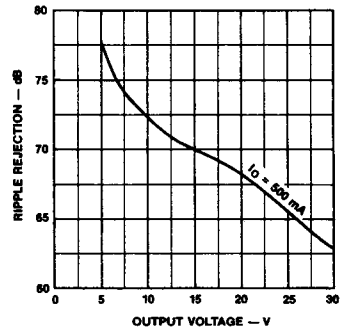

PC11840F

Dropout Voltage vs Junction Temperature vs Frequency

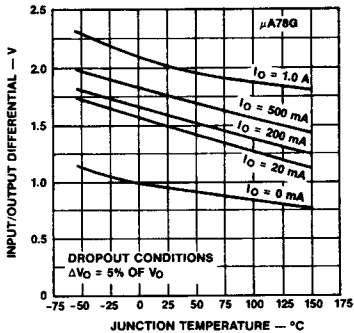

PC11851F

Load Transient Response

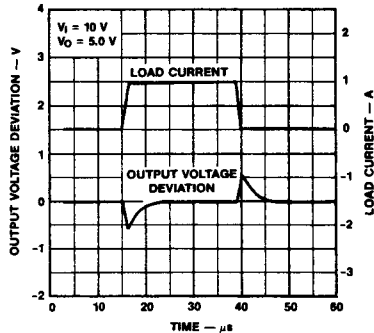

PC11870F

Ripple Rejection vs Frequency

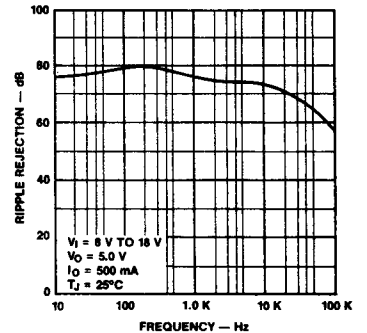

PC11860F

Typical Performance Curves for μA79G

Line Transient Response for μA78G

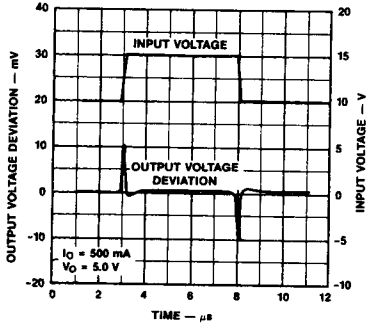

PC11680F

Peak Output Current vs Input/Output Differential Voltage

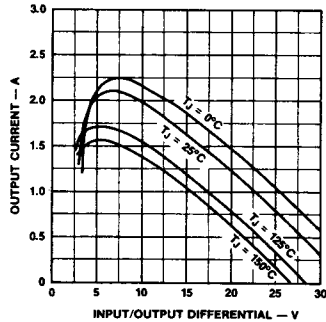

PC11690F

Quiescent Current vs Input Voltage

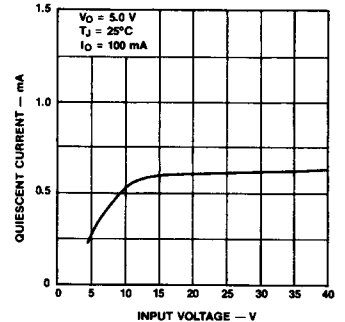

PC11700F

Control Current vs Junction Temperature

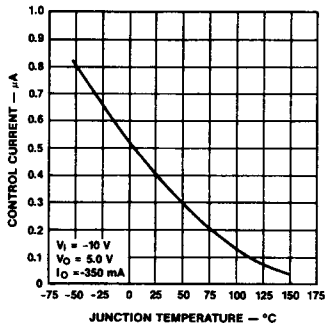

PC11710F

Differential Control Voltage vs Input Voltage

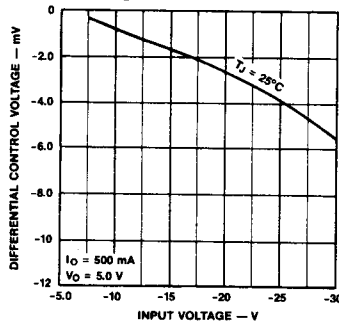

PC11720F

Differential Control Voltage vs Output Current

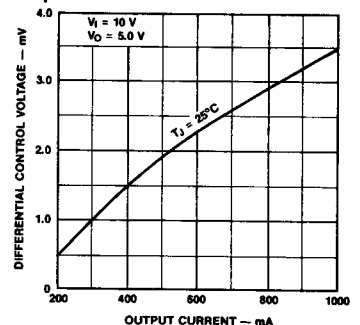

PC11730F

Ripple Rejection vs Output Voltage

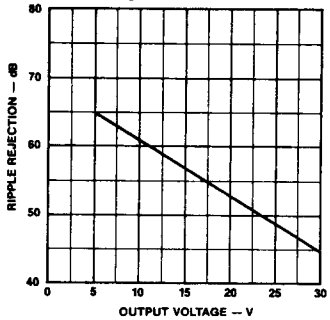

PC11740F

Dropout Voltage vs Junction Temperature

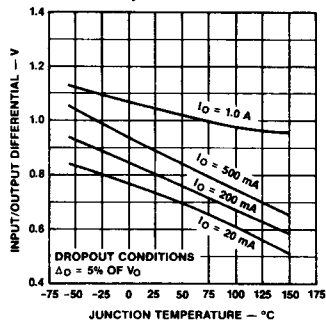

PC11750F

Ripple Rejection vs Frequency

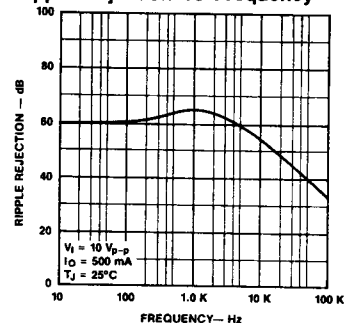

PC11760F

Typical Performance Curves for μA79G (Cont.)

Load Transient Response

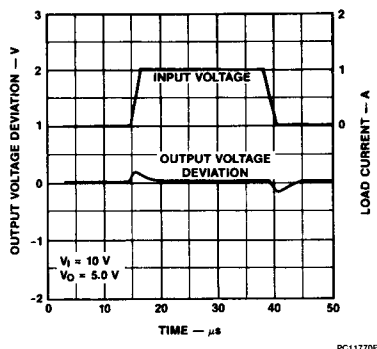

Line Transient Response

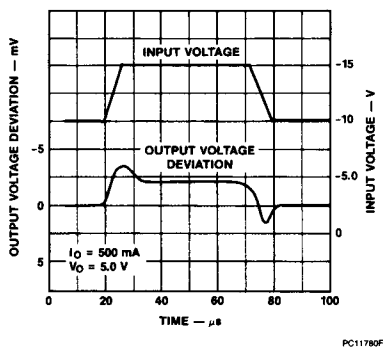

6

Test Circuits

μA78G Test Circuit 1

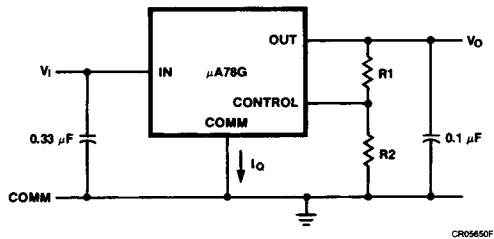

$$V_O = \left(\frac{R_1 + R_2}{R_2} \right) V_{CONT}$$

V_{CONT} Nominal = 5.0 V

Design Considerations

The μA78G and μA79G Adjustable Voltage Regulators have an output voltage which varies from V_{CONT} to typically

$$V_i - 2.0 \text{ V by } V_O = V_{CONT} \frac{R_1 + R_2}{R_2}$$

The nominal reference in the μA78G is 5.0 V and μA79G is -2.23 V. If we allow 1.0 mA to flow in the control string to eliminate bias current effects, we can make $R_2 = 5.0 \text{ k}\Omega$ in the μA78G. Then, the output voltage is; $V_O = (R_1 + R_2) \text{ V}$, where R_1 and R_2 are in $\text{k}\Omega$ s.

Example: If $R_2 = 5.0 \text{ k}\Omega$ and $R_1 = 10 \text{ k}\Omega$ then $V_O = 15 \text{ V}$ nominal, for the μA78G
 $R_2 = 2.2 \text{ k}\Omega$ and $R_1 = 12.8 \text{ k}\Omega$ then $V_O = -15.2$ nominal, for the μA79G

μA79G Test Circuit 2

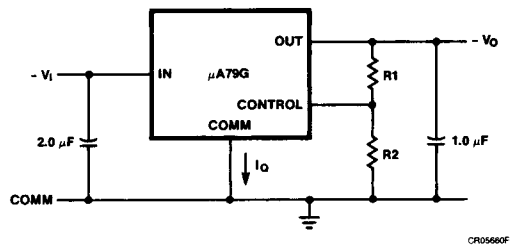

$$V_O = \left(\frac{R_1 + R_2}{R_2} \right) V_{CONT}$$

V_{CONT} Nominal = -2.23 V
 Recommended R_2 current $\approx 1.0 \text{ mA}$
 $\therefore R_2 = 5.0 \text{ k}\Omega$ (μA78G)
 $R_2 = 2.2 \text{ k}\Omega$ (μA79G)

By proper wiring of the feedback resistors, load regulation of the device can be improved significantly.

Both μA78G and μA79G regulators have thermal overload protection from excessive power, internal short circuit protection which limits each circuit's maximum current, and output transistor safe-area protection for reducing the output current as the voltage across each pass transistor is increased.

Although the internal power dissipation is limited, the junction temperature must be kept below the maximum specified temperature in order to meet data sheet specifications. To calculate the maximum junction temperature or heat sink required, the following thermal resistance values should be used:

	Typ °C/W	Max °C/W	Typ °C/W	Max °C/W
Package	θ_{JC}	θ_{JC}	θ_{JA}	θ_{JA}
Power Watt	7.5	11	75	80

$$P_{D \text{ Max}} = \frac{T_J \text{ Max} - T_A}{\theta_{JC} + \theta_{CA}} \text{ or}$$

$$= \frac{T_J \text{ Max} - T_A}{\theta_{JA}} \text{ (without a heat sink)}$$

$$\theta_{CA} = \theta_{CS} + \theta_{SA}$$

Solving for T_J :

$$T_J = T_A + P_D(\theta_{JC} + \theta_{CA}) \text{ or}$$

$$= T_A + P_D\theta_{JA} \text{ (without heat sink)}$$

Where:

- T_J = Junction Temperature
- T_A = Ambient Temperature
- P_D = Power Dissipation
- θ_{JA} = Junction to ambient thermal resistance
- θ_{JC} = Junction to case thermal resistance
- θ_{CA} = Case to ambient thermal resistance
- θ_{CS} = Case to heat sink resistance
- θ_{SA} = Heat sink to ambient thermal resistance

**μA78G and μA79G
Power Tab (U1) Package
Worst Case Power Dissipation vs
Ambient Temperature**

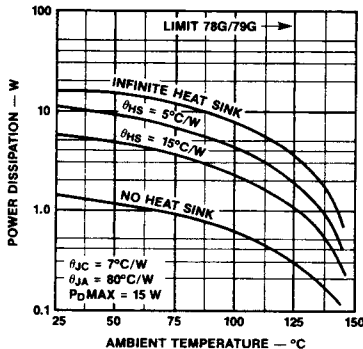

PC11880F

Typical Applications For μA78G (Note 1)

Bypassing of the input and output (0.33 μF and 0.1 μF, respectively) is necessary.

Basic Positive Regulator

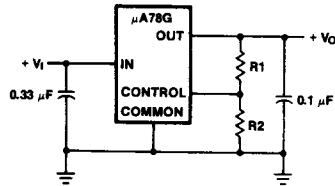

$$V_O = V_{CONT} \left(\frac{R_1 + R_2}{R_2} \right)$$

CR05670F

Positive 5.0 V to 30 V Adjustable Regulator

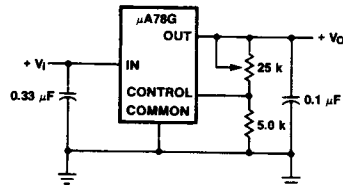

CR05680F

Note

1. All resistor values in ohms.

Typical Applications For μA78G (Note 1) (Cont.)

Positive 5.0 V to 30 V Adjustable Regulator
($I_O > 5.0$ A) (Note 2)

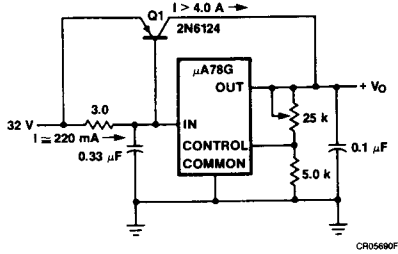

Positive High Current, Short Circuit Protected Regulator

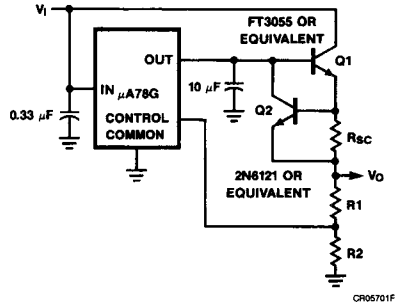

Positive High Current Short Circuit, Protected Regulator

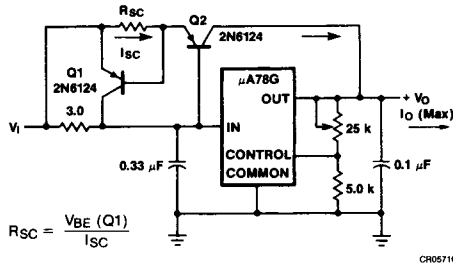

± 10 V, 1.0 A
Dual Tracking Regulator (Note 3)

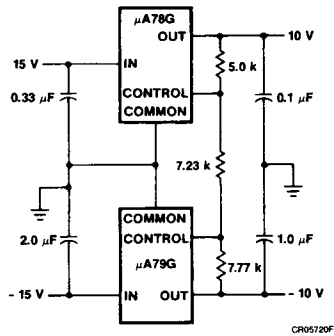

Notes

1. All resistor values in ohms.
2. External series pass device is not short circuit protected.
3. If load is not ground referenced, connect reverse biased diodes from outputs to ground.