

μ A79HG 5 A Negative Adjustable Voltage Regulator

Hybrid Products

Description

The μ A79HG is an adjustable 4-terminal negative voltage regulator capable of supplying in excess of -5 A over a -24 V to -2.11 V output range. The μ A79HG hybrid voltage regulator has been designed with all the inherent characteristics of the monolithic 4-terminal regulator; i.e., full thermal overload and short circuit protection. The μ A79HG is packaged in a hermetically-sealed 4-pin TO-3 package providing 50 W power dissipation. The regulator consists of a monolithic chip driving a discrete-series pass element and short circuit detection transistors.

- **-5.0 A OUTPUT CURRENT**
- **INTERNAL CURRENT AND THERMAL OVERLOAD PROTECTION**
- **INTERNAL SHORT CIRCUIT CURRENT LIMIT**
- **LOW DROP-OUT VOLTAGE (TYPICALLY 2.2 V @ 5.0 A)**
- **50 W POWER DISSIPATION**
- **ELECTRICALLY NEUTRAL CASE**
- **STEEL TO-3 CASE**

Connection Diagram 4-Pin Metal Package

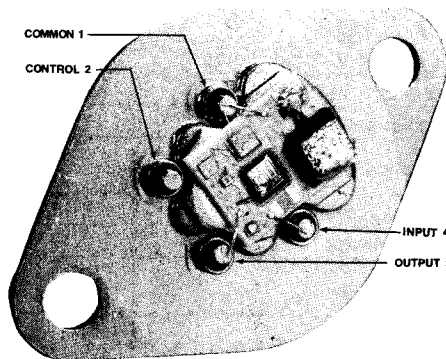

(Top View)

Order Information

Type	Package	Code	Part No.
μ A79HG	Metal	JA	μ A79HGSC
μ A79HG	Metal	JA	μ A79HGSM

Block Diagram

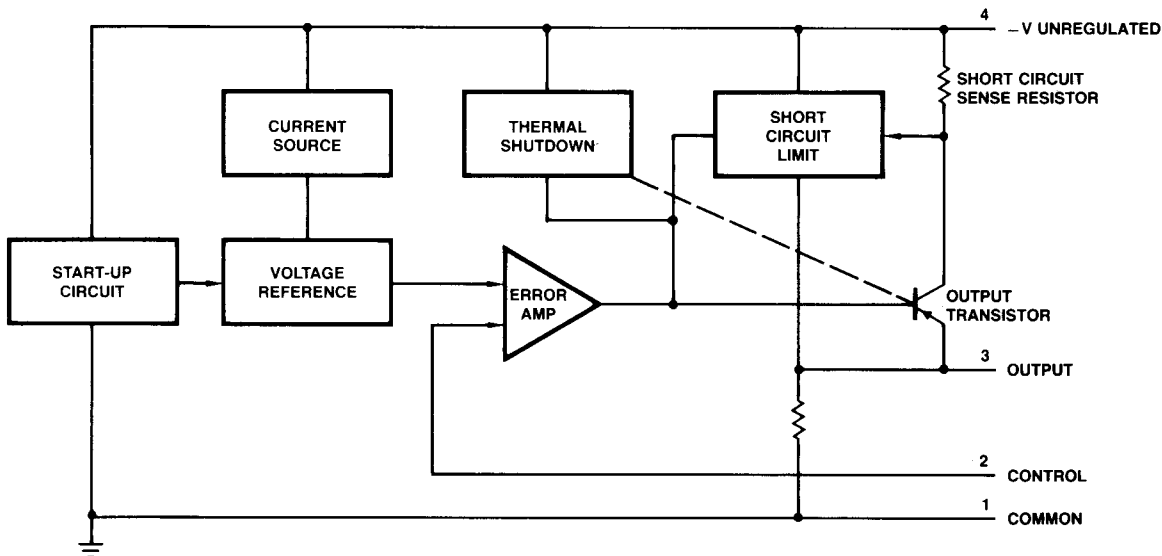

Absolute Maximum Ratings

Input Voltage	-40 V	Storage Temperature Range	-55°C to +150°C
Internal Power Dissipation	50 W @ 25°C Case	Pin Temperature	
Maximum Input-to-Output Voltage Differential	-35 V	(Soldering, 60 s)	300°C
Operating Junction Temperature Range	0°C to +150°C		

μA79HG

Electrical Characteristics $T_J = 25^\circ\text{C}$, $V_{IN} = -10\text{ V}$ and $I_{OUT} = -2.0\text{ A}$ unless otherwise specified.

Characteristic	Limits			Unit	Condition
	Min	Typ	Max		
Input Voltage Range	-40		-7.0	V	
Nominal Output Voltage Range	-24		-2.11	V	$V_{IN} = V_{OUT} - 5\text{ V}$
Output Voltage Tolerance			4	%(V_{OUT})	$-40\text{ V} \leq V_{IN} \leq -7\text{ V}$
Line Regulation		0.4	1.0	%(V_{OUT})	$-40\text{ V} \leq V_{IN} \leq -7\text{ V}$
Load Regulation		0.7	1.0	%(V_{OUT})	$V_{IN} = V_{OUT} - 10\text{ V}$, $-10\text{ mA} \leq I_{OUT} \leq -5.0\text{ A}$
Control Pin Current			3.0	μA	
Quiescent Current			-5.0	mA	$V_{IN} = -10\text{ V}$
Ripple Rejection		50		dB	$-18\text{ V} \leq V_{IN} \leq -8.5\text{ V}$ $V_{OUT} = -5\text{ V}$, $f = 120\text{ Hz}$
Output Noise Voltage		200		μV	$10\text{ Hz} \leq f \leq 100\text{ kHz}$, $V_{OUT} = -5.0\text{ V}$
Dropout Voltage		2.2		V	$I_{OUT} = -5\text{ A}$
Short Circuit Current Limit		-8	-12	A	$V_{IN} = -15\text{ V}$
Control Pin Voltage (Reference)	-2.35		-2.11	V	$V_{IN} = -10\text{ V}$

Typical Performance Curves

Short Circuit Current

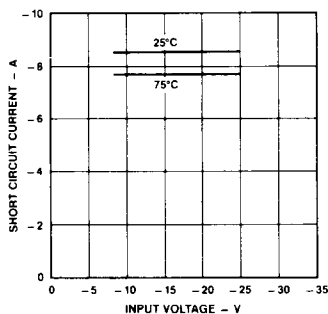

Quiescent Current

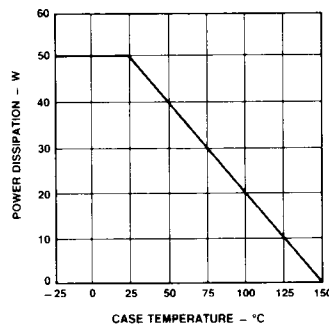

Dropout Voltage

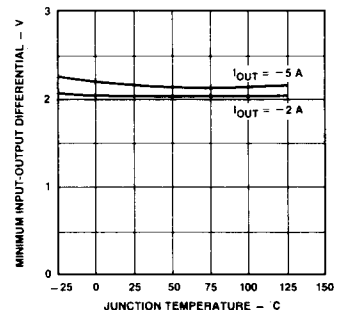

Typical Performance Curves (Cont.)

Line Transient Response

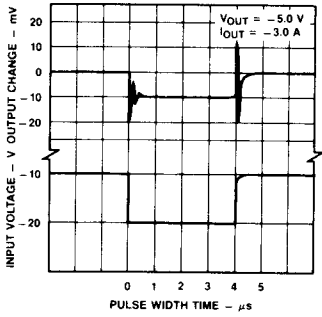

Load Regulation

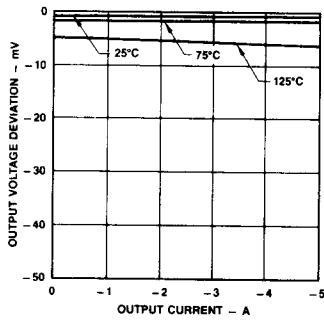

Load Transient Response

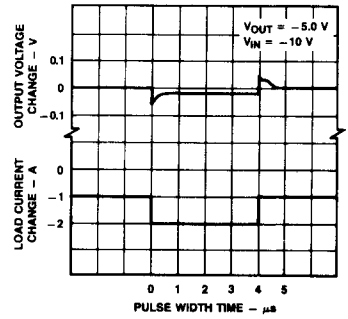

Output Voltage Deviation vs Junction Temperature

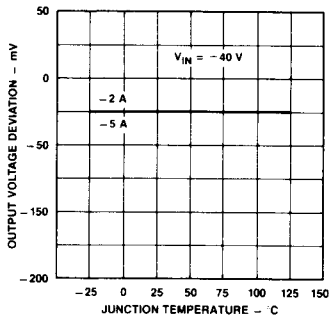

Control Current vs Temperature

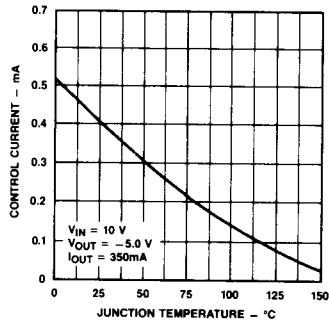

Differential Control Voltage vs Input Voltage

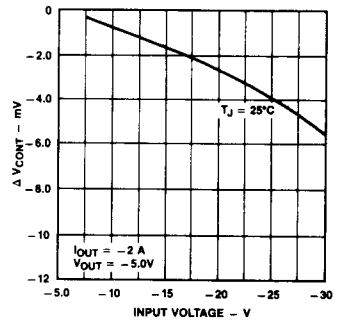

Maximum Power Dissipation

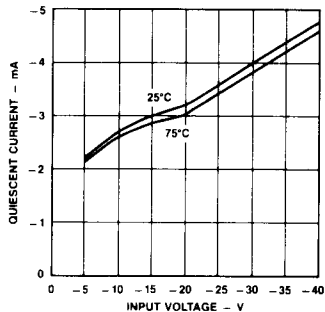

Basic Test Circuit, Adjustable Output Voltage

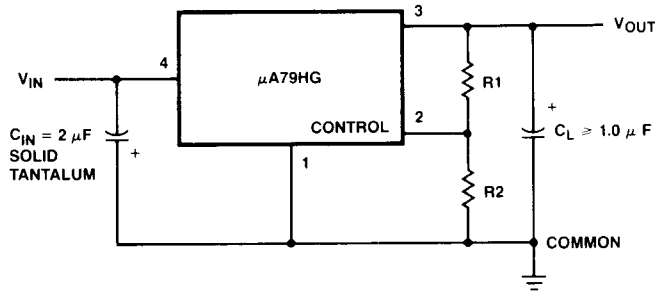

$$V_{OUT} = V_{CONTROL} \left(\frac{R_1 + R_2}{R_2} \right)$$

Design Considerations

This device has thermal overload protection from excessive power and internal short circuit protection which limits the circuit's maximum current. Thus, the device is protected from overload abnormalities. Although the internal power dissipation is limited, the junction temperature must be kept below the maximum specified temperature (150°C). It is recommended by the manufacturer that the maximum junction temperature be kept as low as possible for increased reliability. To calculate the maximum junction temperature or heat sink required, the following thermal resistance values should be used.

Package	Typ	Max
	θ_{JC}	θ_{JC}
TO-3	1.8	2.5

$$P_{D(MAX)} = \frac{T_{J(MAX)} - T_A}{\theta_{JC} + \theta_{CA}}$$

$$\theta_{CA} = \theta_{CS} + \theta_{SA}$$

Solving for T_J :

$$T_J = T_A + P_D (\theta_{JC} + \theta_{CA})$$

Where:

T_J = Junction Temperature

T_A = Ambient Temperature

P_D = Power Dissipation

θ_{JC} = Junction-to-case thermal resistance

θ_{CA} = Case-to-ambient thermal resistance

θ_{CS} = Case-to-heat sink thermal resistance

θ_{SA} = Heat sink-to-ambient thermal resistance

The device is designed to operate without external compensation components. However, the amount of external filtering of these voltage regulators depends upon the circuit layout. If in a specific application the regulator is more than four inches from the filter capacitor, a 2 μF solid tantalum capacitor should be used at the input. A 1 μF capacitor should be used at the output to reduce transients created by fast switching loads, as seen in the basic test circuit. These filter capacitors must be located as close to the regulator as possible.

Caution: Permanent damage can result from forcing the output voltage higher than the input voltage. A protection diode from output to input should be used if this condition exists.

Voltage Output

The device has an adjustable output voltage from -2.11 to -24 V which can be programmed by the external resistor network (potentiometer or two fixed resistors) using the relationship:

$$V_{OUT} = V_{CONTROL} \left(\frac{R_1 + R_2}{R_2} \right)$$

Example: If $R_1 = 0 \Omega$ and $R_2 = 5 \text{ k}\Omega$, then

$$V_{OUT} = -2.11 \text{ V nominal.}$$

Or, if $R_1 = 12.8 \text{ k}\Omega$ and $R_2 = 2.1 \text{ k}\Omega$ then

$$V_{OUT} = -15 \text{ V.}$$

Package Outline (S Package — Steel)

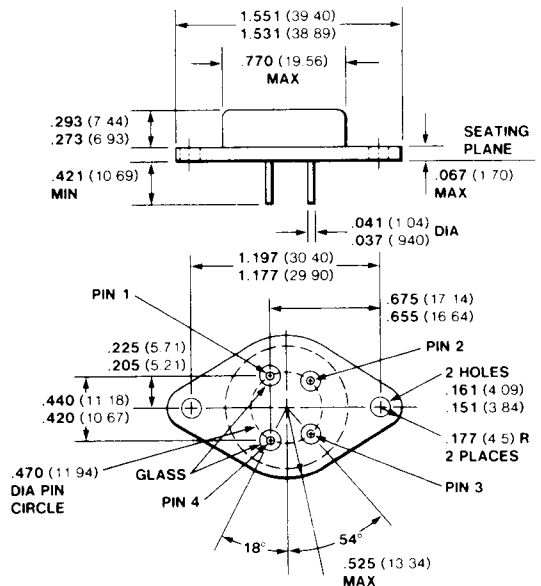

Notes

All dimensions in inches bold and millimeters (parentheses)
Pins are solder-dipped alloy 52