

UNIPAC OPTOELECTRONICS CORPORATION

Spec. No. 413-212-075

Version : 3



Total pages : 15

Date : 2000.08.22

UB104S01 COLOR TFT-LCD MODULE SPECIFICATION

MODEL NAME: UB104S01

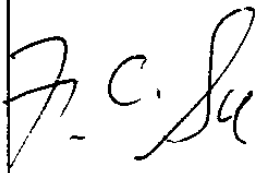
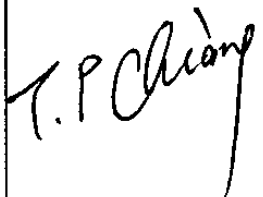
The content of this technical information
is subject to change without notice.
Please contact Unipac or its agent for
further information.

Approved by	Checked by	Prepared by
		

Contents:

A. Physical specifications	P2
B. Electrical specifications	P3
1. Pin assignment.....	P3
2. Absolute maximum ratings.....	P4
3. Electrical characteristics.....	P5
a. Typical operating conditions.....	P5
b. Display color v.s. input data signals.....	P6
c. Input signal timing.....	P7
d. Display position.....	P8
e. Backlight driving conditions.....	P9
C. Optical specifications	P10
D. Reliability test items	P12
E. Display quality	P12
F. Handling precaution	P12
G. Packing form	P13
Appendix:	
Fig.1 LCM outline dimensions.....	P14
Fig.2 Timing chart.....	P15

A. Physical specifications

NO.	Item	Specification	Remark
1	Display resolution(pixel)	800(H)x 600(V)	
2	Active area(mm)	211.2(H)x 158.4(V)	
3	Screen size(inch)	10.4(Diagonal)	
4	Pixel pitch(mm)	0.264(H)x 0.264(V)	
5	Color configuration	R. G. B. Vertical stripe	
6	Overall dimension(mm)	236(W)x 174.3(H)x 5.6(D)	Note 1
7	Weight(g)	295± 10	

Note 1: Refer to Fig. 1.

B. Electrical specifications

1.Pin assignment

(1).Input signal interface

Pin no	Symbol	Function	Etc.
1	V _{CC}	+3.3 V power supply	
2	V _{CC}	+3.3 V power supply	
3	GND	Ground	
4	GND	Ground	
5	RxIN0-	LVDS receiver signal channel 0	
6	RxIN0+		
7	GND	Ground	
8	RxIN1-	LVDS receiver signal channel 1	
9	RxIN1+		
10	GND	Ground	
11	RxIN2-	LVDS receiver signal channel 2	
12	RxIN2+		
13	GND	Ground	
14	CKIN-	LVDS receiver signal clock	
15	CKIN+		
16	GND	Ground	
17	NC	No Connection	
18	NC	No Connection	
19	GND	Ground	
20	GND	Ground	

CN1 (20P) connector : HRS DF 19K-20P-1H or compatible

(2) LVDS transmitter/receiver signal mapping

	Symbol	Function	
TxIN0	R0	Red data (LSB)	6 bit red display data
TxIN1	R1	Red data	
TxIN2	R2	Red data	
TxIN3	R3	Red data	
TxIN4	R4	Red data	
TxIN5	R5	Red data (MSB)	
TxIN6	G0	Green data (LSB)	6 bit green display data
TxIN7	G1	Green data	
TxIN8	G2	Green data	
TxIN9	G3	Green data	
TxIN10	G4	Green data	
TxIN11	G5	Green data (MSB)	
TxIN12	B0	Blue data (LSB)	6 bits blue display data
TxIN13	B1	Blue data	
TxIN14	B2	Blue data	
TxIN15	B3	Blue data	
TxIN16	B4	Blue data	
TxIN17	B5	Blue data (MSB)	
TxIN18	Hs	Horizontal sync.	
TxIN19	Vs	Vertical sync.	
TxIN20	DE	Data enable	
TxCLKIN	CLK	Clock	Dot clock

2. Absolute maximum ratings

(GND = 0 V)

Parameter	Symbol	Values		Unit	Remark
		Min.	Max.		
Power voltage	V_{CC}	-0.3	4	V_{DC}	At 25°C
Input signal voltage	V_{LH}	-0.3	$V_{CC}+0.3$	V_{DC}	At 25°C
Operating temperature	Top	0	+60	°C	Note 1
Storage temperature	T _{ST}	-20	+70	°C	Note 1

Note 1: The relative humidity must not exceed 90% non-condensing at temperatures of 40°C or less. At temperatures greater than 40°C, the wet bulb temperature must not exceed 39°C. When operate at low temperatures, the brightness of CCFL will drop and the life time of CCFL will be reduced.

Note 2: The unit should not be exposed to corrosive chemicals.

3. Electrical characteristics

a. Typical operating conditions

	Item	Symbol	Min.	Typ.	Max.	Unit	Remark
Power supply voltage	Input voltage	V_{CC}	3.0	3.3	3.6	V	
	Current consumption	I_A		230		mArms	Note 1
		I_B		260	310	mArms	
	Inrush current	I_{RUSH}	-	-	1500	mApeak	Note 2
Internal logic	Low voltage	V_{IL}	0	-	$0.3 V_{CC}$		
	High voltage	V_{IH}	$0.7V_{CC}$	-	V_{CC}		
	Power ripple voltage	V_{RP}	-	-	100	mVp-p	

Note 1: Effective value (mArms) at $V_{CC} = 3.3 V/25^{\circ}C$.

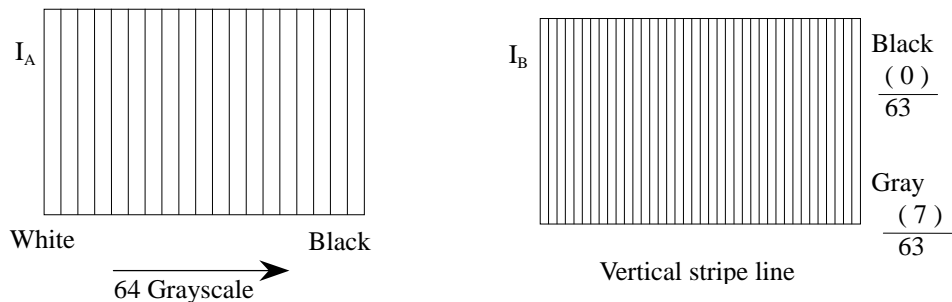

Note 2: Refer to the following power-on condition.

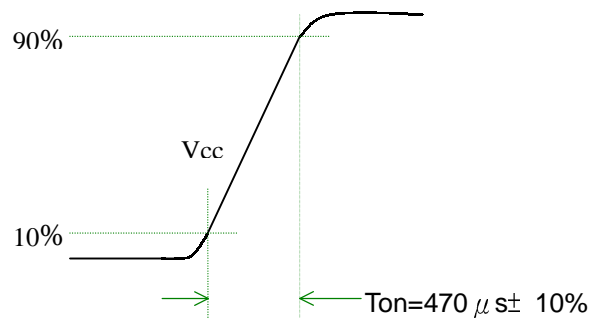

Sequence of Power-on/off and signal-on/off

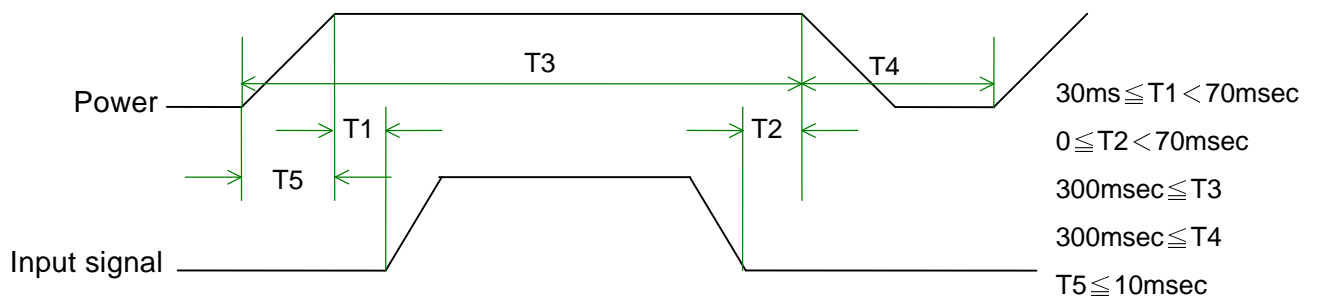

Apply the lamp voltage within the LCD operating range. When the backlight turns on before the LCD operation or the LCD turns off before the backlight turns off, the display may momentarily become abnormal.

Caution

The above on/off sequence should be applied to avoid abnormal function in the display.

In case of handling:

Make sure to turn off the power when you plug the cable into the input connector or pull the cable out of the connector.

b. Display color v.s. input data signals

Display colors		Data signal (0 : Low level, 1: High level)																	
		R5	R4	R3	R2	R1	R0	G5	G4	G3	G2	G1	G0	B5	B4	B3	B2	B1	B0
Basic colors	Black	0	0	0	0	0	0	0	0	0	0	0	0	0	0	0	0	0	0
	Blue	0	0	0	0	0	0	0	0	0	0	0	0	1	1	1	1	1	1
	Red	1	1	1	1	1	1	0	0	0	0	0	0	0	0	0	0	0	0
	Magenta	1	1	1	1	1	1	0	0	0	0	0	0	1	1	1	1	1	1
	Green	0	0	0	0	0	0	1	1	1	1	1	1	0	0	0	0	0	0
	Cyan	0	0	0	0	0	0	1	1	1	1	1	1	1	1	1	1	1	1
	Yellow	1	1	1	1	1	1	1	1	1	1	1	1	0	0	0	0	0	0
	White	1	1	1	1	1	1	1	1	1	1	1	1	1	1	1	1	1	1
Red grayscale	Black	0	0	0	0	0	0	0	0	0	0	0	0	0	0	0	0	0	0
	Dark	0	0	0	0	0	1	0	0	0	0	0	0	0	0	0	0	0	0
	↑																		
	↓																		
	bright	1	1	1	1	0	1	0	0	0	0	0	0	0	0	0	0	0	0
	Red	1	1	1	1	1	1	0	0	0	0	0	0	0	0	0	0	0	0
Green grayscale	Black	0	0	0	0	0	0	0	0	0	0	0	0	0	0	0	0	0	0
	Dark	0	0	0	0	0	0	0	0	0	0	1	0	0	0	0	0	0	0
	↑																		
	↓																		
	bright	0	0	0	0	0	0	1	1	1	1	0	1	0	0	0	0	0	0
	Green	0	0	0	0	0	0	1	1	1	1	1	0	0	0	0	0	0	0
Blue grayscale	Black	0	0	0	0	0	0	0	0	0	0	0	0	0	0	0	0	0	0
	Dark	0	0	0	0	0	0	0	0	0	0	0	0	0	0	0	0	1	0
	↑																		
	↓																		
	bright	0	0	0	0	0	0	0	0	0	0	0	0	1	1	1	1	0	1
	Blue	0	0	0	0	0	0	0	0	0	0	0	0	1	1	1	1	1	1

Note : Each basic color can be displayed in 64 gray scales using the 6 bit data signals. By combining the 18-bit data signals(R, G, B), the 262, 144 colors can be achieved on the display.

c. Input signal timing

Timing diagrams of input signal are shown in Fig 2.

(1). Timing characteristics of input signals

(a) DE mode

Item	Symbol	Min.	Typ.	Max.	Unit	Remark
Clock frequency	Fck	38	40	48	MHz	
Horizontal blanking	Thb1	50	256	500	Clk	
Vertical blanking	Tvb1	10	28	150	Th	

(b) HV mode

Item	Symbol	Min.	Typ.	Max.	Unit	Remark
Clock frequency	Fck	38	40	48	MHz	
Hsync period	Th	850	1056	1300	Clk	
Hsync pulse width	Thw	10	128	-	Clk	
Hsync front porch	Thf	15	40	-	Clk	
Hsync back porch	Thb	10	88	-	Clk	
Hsync blanking	Thb1	50	256	500	Clk	
Vsync period	Tv	610	628	750	Th	
Vsync pulse width	Tvw	1	4	-	Th	
Vsync front porch	Tvf	0	1	-	Th	
Vsync blanking	Tvb1	10	28	150	Th	
Hsync/Vsync phase shift	Tvpd	2	320	-	Clk	

Item	Symbol	Value	Unit	Description
Horizontal display start	The	218	Clk	After falling edge of Hsync, counting 218clk, then getting valid data from 219th clk's data.
Vertical display start	Tve	25	Th	After falling edge of Vsync, counting 25th, then getting 26th Th's data.

(2). The timing condition of LVDS

Item	Symbol	Min.	Typ.	Max.	Unit
The differential level	VID	0.1	-	0.6	V
The common mode input voltage	VIC	$\frac{ VID }{2}$	-	$2.4 - \frac{ VID }{2}$	V
The input setup time	tsu1	500	-	-	ps
The input hold time	th1	500	-	-	ps

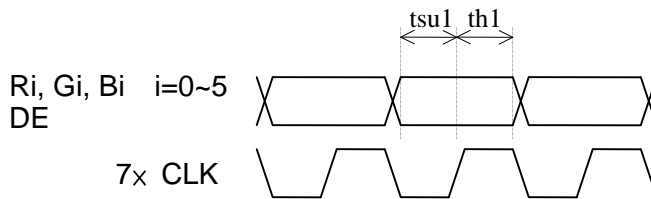
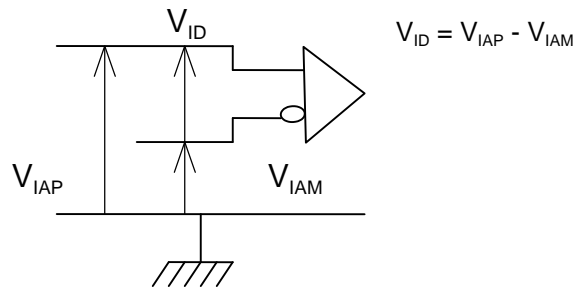

d. Display position

D(1,1)	D(2,1)	D(X,1)	D(799,1)	D(800,1)
D(1,2)	D(2,2)	D(X,2)	D(799,2)	D(800,2)
⋮		⋮	⋮	⋮
D(1,Y)	D(2,Y)	D(X,Y)	D(799,Y)	D(800,Y)
⋮		⋮	⋮	⋮
D(1,599)	D(2,599)	D(X,599)	D(799,599)	D(800,599)
D(1,600)	D(2,600)	D(X,600)	D(799,600)	D(800,600)

e. Backlight driving conditions

Parameter	Symbol	Min.	Typ.	Max.	Unit	Remark
Lamp voltage	V_L	-	560	-	Vrms	Note 1
Lamp current	I_L	-	4.5	-	mArms	Note 1
Power consumption	P_L	-	2.52	-	W	Note 2
Lamp starting voltage	V_s	-	-	1050	Vrms	$T=0^{\circ}\text{C}$
		-	-	800		$T=25^{\circ}\text{C}$
Frequency	F_L	-	60	-	KHz	Note 3
Lamp life time	L_L	10000	20000	-	Hr	Note 1, 4

Note 1: $T=25^{\circ}\text{C}$, $I_L=4.5\text{mA}$

Note 2: Inverter should be designed with the characteristic of lamp. When you are designing the inverter, the output voltage of the inverter should comply with the following conditions.

- (1). The area under the positive and negative cycles of the waveform of the lamp current and lamp voltage should be area symmetric(the symmetric ratio should be larger than 90%).
- (2). There should not be any spikes in the waveform.
- (3). The waveform should be sine wave as possible.
- (4). Lamp current should not exceed the maximum value within the operating Temperature (It is prohibited to over the maximum lamp current even if operated in The non-guaranteed temperature). When lamp current over the maximum value for a long time, it may cause fire. Therefore, it is recommend that the inverter should have the current limited circuit.

Note 3: Lamp frequency may produce interference with horizontal synchronous frequency and this may cause line flow on the display. Therefore lamp frequency shall be detached from the horizontal synchronous frequency and its harmonics as far as possible in order to avoid interference.

Note 4: Brightness ($I_L=4.5\text{mA}$) to be decrease to the 50% of the initial value.

Note 5: CN2 connector(backlight): JST BHSR-02VS-1

Mating connector: JST SM02B-BHSS-1-TB

Pin no.	Symbol	Function	Remark
1	H	CCFL power supply(H.V.)	Cable color: Pink
2	L	CCFL power supply(GND)	Cable color: White

C. Optical specifications (Note 1, Note 2)

Item	Symbol	Condition	Specification			Unit	Remark
			Min.	Typ.	Max.		
Response time Rising time Falling time	Tr Tf	$\theta = 0^\circ$	- -	20 30	40 50	ms	Note 4
Contrast ratio	CR	$\theta = 0^\circ$	150	250	-		Note 3,5
Viewing angle Top Bottom Left Right		$CR \geq 10$	10 30 40 40	15 35 45 45	- - - -	deg.	Note 3,6
Brightness	Y_L	$\theta = 0^\circ$	130	150	-	nit	Note 3,7,8,9
Color chromaticity(CIE)	Wx	$\theta = 0^\circ$	-	0.310	-		Note 3,8,9
	Wy		-	0.325	-		
	Rx		-	0.570	-		
	Ry		-	0.313	-		
	Gx		-	0.300	-		
	Gy		-	0.560	-		
	Bx		-	0.145	-		
	By		-	0.120	-		
White uniformity	δ_w		-	-	1.8		Note 3,9,10

Note 1: Ambient temperature = 25°C .

Note 2: To be measured in dark room after backlight warm up 30 minutes.

Note 3: To be measured with a viewing cone of 1° by Topcon luminance meter BM-5A.

Note 4: Definition of response time:

The output signals of BM-7 are measured when the input signals are changed from “Black” to “White” (falling time) and from “White” to “Black” (rising time), respectively. The response time means the interval between the 10% and 90% of amplitudes. Refer to figure as below.

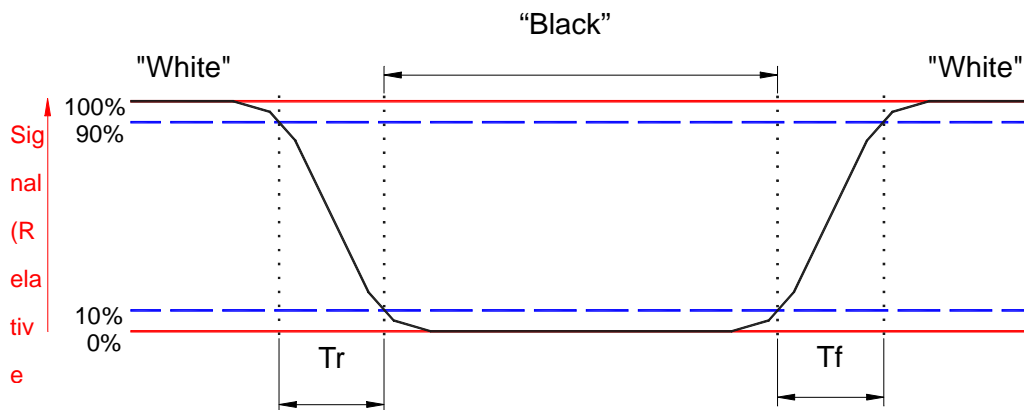

Note 5. Definition of contrast ratio:

Contrast ratio is calculated with the following formula.

$$\text{Contrast ratio (CR)} = \frac{\text{Luminance on the white raster}}{\text{Luminance on the black raster}}$$

Note 6: Definition of viewing angle:

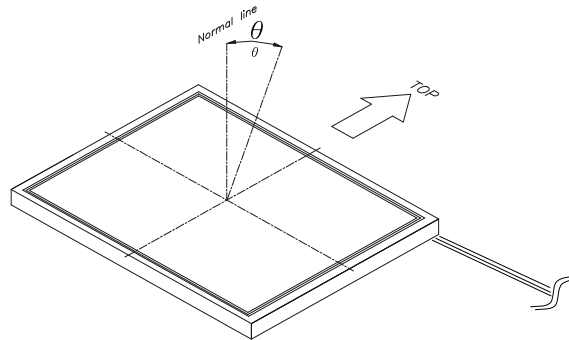

Note 7: Definition of the 13 points (from A to M) on panel, refer to figure as below

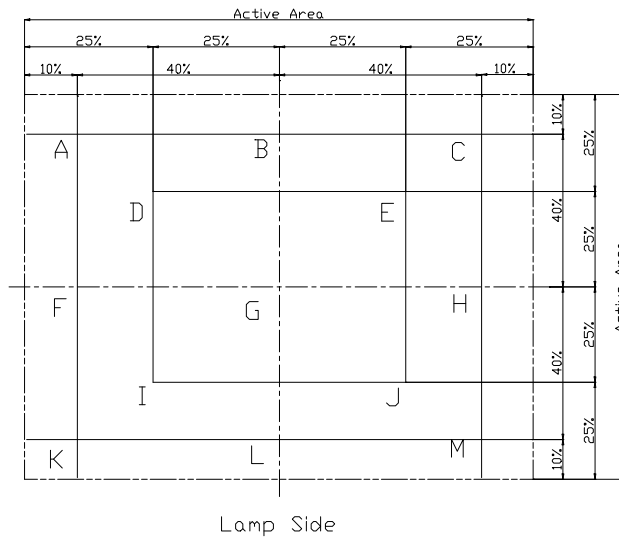

Note 8: Definition of brightness: To average the luminance of center 5 points (D, E, G, I, J)

Note 9: Driving conditions for CCFL : $I_L=4.5$ mA, 60KHz Frequency

Note 10: Definition of white uniformity:

$$\delta_w = \frac{\text{Maximum Luminance of thirteen points (brightness)}}{\text{Minimum Luminance of thirteen points (brightness)}}$$

D. Reliability test items (Note 1)

Test tem	Test Condition	Remark
High temperature storage	70°C, 240Hrs	Note 1, 2, 3
Low temperature storage	-20°C, 240Hrs	Note 1, 2, 3
High temperature & high humidity operation	40°C, 90%RH, 240Hrs (No condensation)	Note 1, 2, 3
High temperature operation	60°C, 240Hrs	Note 1, 2, 3
Low temperature operation	0°C, 240Hrs	Note 1, 2, 3
Temperature cycling (non-operation)	-20°C~70°C 1H, 10mins, 1H, 5cycles	Note 1, 2, 3
Electrostatic discharge (non-operation)	150 pF, 150Ω, 10kV, 1 second, 9 position on the panel, 10 times each place	Note 3
Vibration (non-operation)	Sweep: 1G, 10Hz ~ 500Hz ~ 10Hz/2.5min 2 hours for each direction X, Y, Z (6 Hrs in total)	Note 1, 2, 3
Mechanical shock (non-operation)	50G/11ms, 200G/2ms, ± X, ± Y, ± Z once for each direction	Note 1, 2, 3

Note 1: Evaluation should be tested after storage at room temperature for one hour.

Note 2: There should be no change which might affect the practical display function when the display quality test is conducted under normal operating condition.

Note 3: Judgement: 1. Function OK

2. No serious image quality degradation

E. Display quality

The display quality of the color TFT-LCD module should be in compliance with the Unipac's OQC inspection standard.

F. Handling precaution

The Handling of the TFT-LCD should be in compliance with the Unipac's handling principle standard.

G. Packing form :

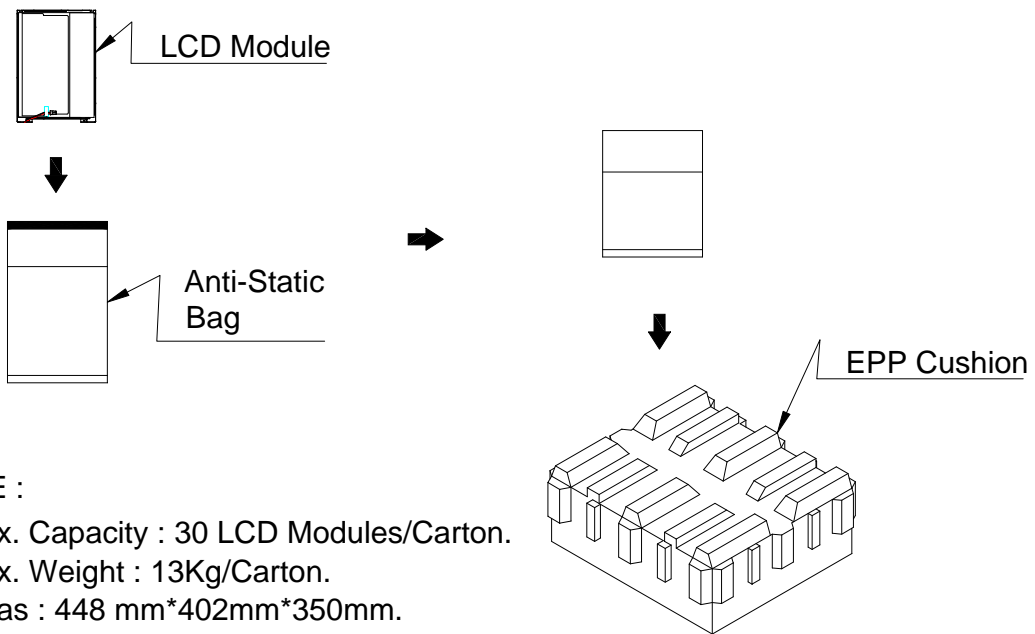

- NOTE :**
- 1. Max. Capacity : 30 LCD Modules/Carton.
 - 2. Max. Weight : 13Kg/Carton.
 - 3. Meas : 448 mm*402mm*350mm.

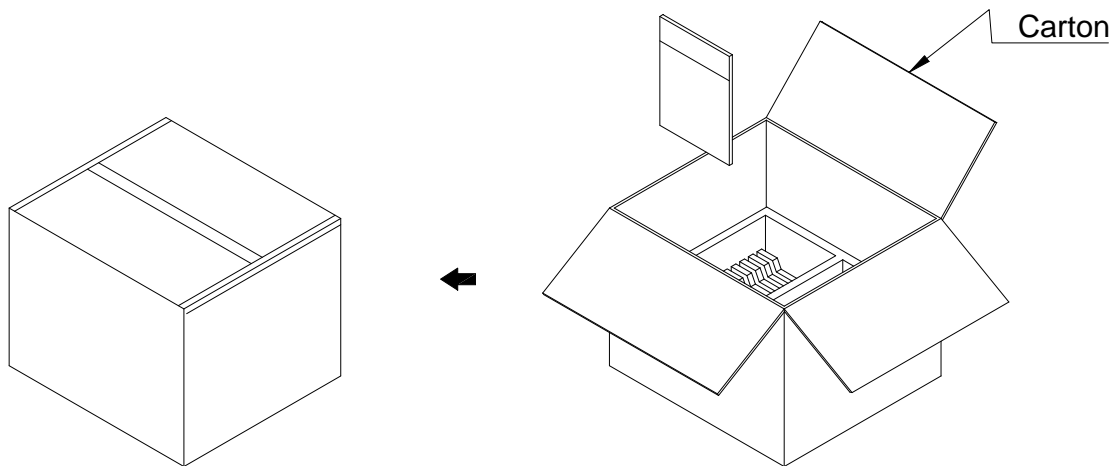

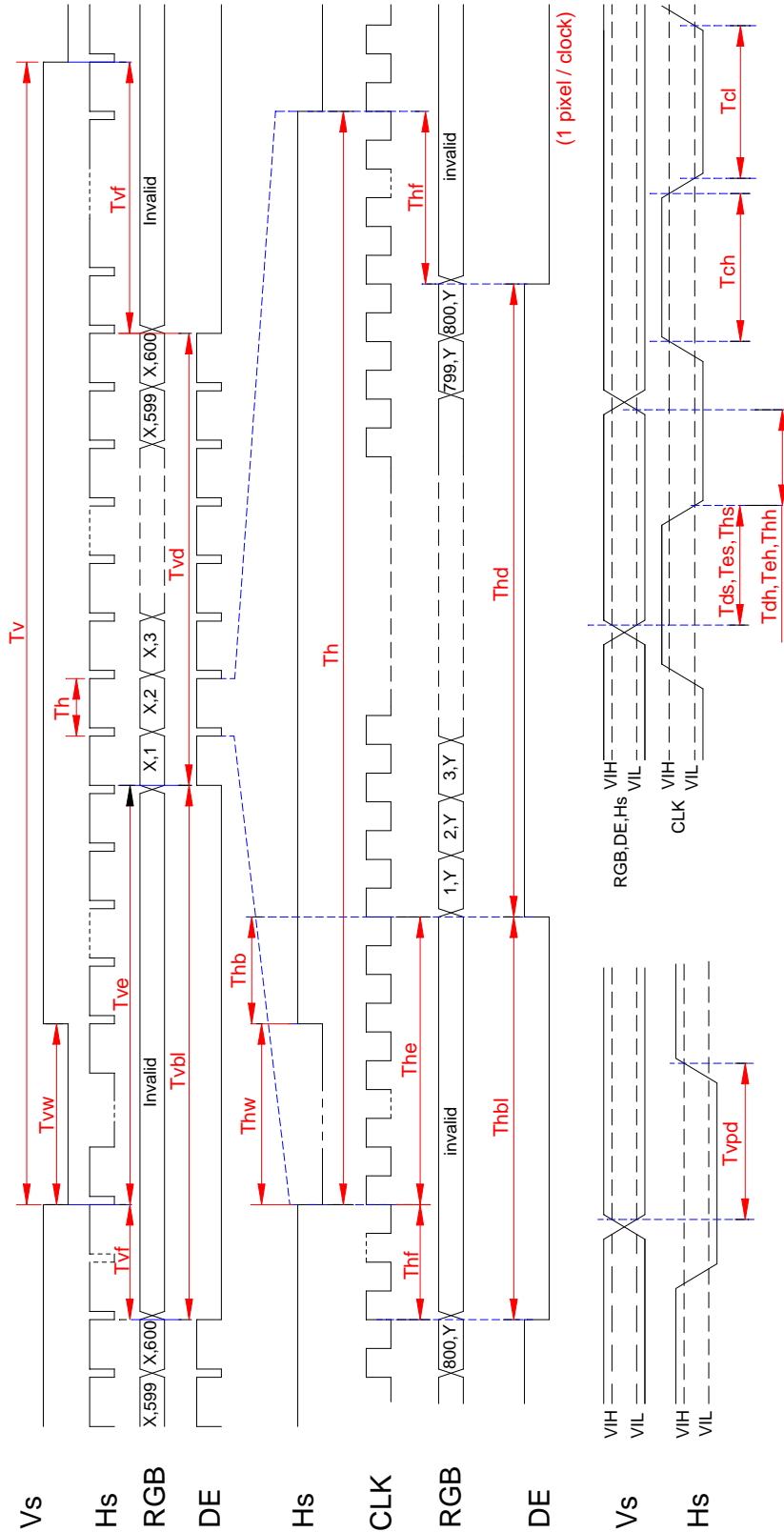

Fig.2 Timing chart

UNIPAC OPTOELECTRONICS CORPORATION

TERMS AND CONDITIONS OF SALE

These Terms and Conditions of Sale apply to all items designed and/or made by Unipac Optoelectronics Corporation ("Unipac"), and Buyer agrees they apply to all such items.

1 ACCEPTANCE OF TERMS. BUYER ACCEPTS THESE TERMS (i) BY WRITTEN ACCEPTANCE (BY PURCHASE ORDER OR OTHERWISE), OR (ii) BY FAILURE TO RETURN GOODS SUPPLIED BY UNIPAC WITHIN 5 DAYS OF THEIR DELIVERY.

2 DELIVERY

2.1 Delivery will be made Free Carrier (Incoterms 1990), Unipac's warehouse, Science-Based Industrial Park, Taiwan to a carrier designated in writing by Buyer, or if Buyer fails to designate a carrier, to a carrier designated by Unipac.

2.2 Title to the goods and the entire risk will pass to Buyer upon delivery to carrier.

2.3 Shipments are subject to availability. Unipac shall make every reasonable effort to meet the date(s) quoted or acknowledged; and if Unipac makes such effort, UNIPAC WILL NOT BE LIABLE FOR ANY DELAYS.

3 TERMS OF PAYMENT

3.1 Unless otherwise stated on Unipac's quotation, all shipments shall be T/T in advance, by Letter of Credit at Sight, or pursuant to agreed prepayment terms. Unipac reserves the right to change credit terms at any time in its sole discretion.

3.2 Buyer guarantees prompt payment of all obligations accrued pursuant to purchase orders issued by Buyer.

4 LIMITED WARRANTY

4.1 Unipac warrants that the goods sold will be free from defects in material and workmanship and comply with Unipac's applicable published specifications for a period of sixty (60) days from the date of Unipac's shipment.

4.2 Goods or parts which have been subject to abuse (including without limitation repeated or extended exposure to conditions at or near the limits of applicable absolute ratings) misuse, accident, alteration, neglect, or unauthorized repair or improper application are not covered by any warranty. No warranty is made with respect to custom products or goods produced to Buyer's specifications (unless specifically stated in writing signed by Unipac). Unipac shall not be responsible for defects or claims caused by acts not performed by Unipac; or by combination of goods with other things.

4.3 No warranty is made with respect to goods used in devices intended for use in applications where failure to perform when properly used can reasonably be expected to result in significant injury (including, without limitation, navigation, aviation, weaponry or nuclear equipment, or for surgical implant or to support or sustain life) and Buyer agrees to indemnify, defend, and hold harmless Unipac from all claims, damages and liabilities arising out of any such uses.

4.4 This Article 4 is the only warranty by Unipac with respect to goods and may not be modified or amended except in writing signed by an authorized officer of Unipac.

4.5 Buyer acknowledges and agrees that it is not relying on any applications, diagrams or circuits contained in any literature, and Buyer will test all parts and applications under extended field and laboratory conditions. Notwithstanding any cross-reference or any statements of compatibility, functionality, interchangeability, and the like, the goods may differ from similar goods from other vendors in performance, function or operation, and in areas not contained in the written specifications, or as to ranges and conditions outside such specifications; and Buyer agrees that there are no warranties and that Unipac is not responsible for such things.

4.6 REGARDLESS OF CAUSE OR REASON FOR DAMAGE (WHETHER ACCIDENT, NEGLIGENCE, OR OTHERWISE) UNIPAC SHALL HAVE NO LIABILITY (DIRECT, CONSEQUENTIAL OR OTHER) FOR, IN CONNECTION WITH OR ARISING FROM PROPERTY FURNISHED FOR USE AT OR LEFT AT UNIPAC; and by delivering or entrusting property to Unipac, Buyer expressly confirms this limitation. Notwithstanding this limitation, Unipac will replace, or pay the reasonable retooling costs to replace, masks damaged or destroyed as a result of Unipac's gross negligence or fault.

4.7 EXCEPT AS PROVIDED ABOVE, UNIPAC MAKES NO WARRANTIES OR CONDITIONS, EXPRESS, IMPLIED, OR STATUTORY; AND UNIPAC EXPRESSLY EXCLUDES AND DISCLAIMS ANY WARRANTY OR CONDITION OF NON-INFRINGEMENT, MERCHANTABILITY OR FITNESS FOR PARTICULAR PURPOSE OR APPLICATION.

5 LIMITATION OF LIABILITY

5.1 Unipac will not be liable for any loss, damage or penalty resulting from causes beyond its reasonable control, including but not limited to delay by others, force majeure, acts of God, material shortage or labor conditions. In any such event, the date(s) for Unipac's performance will be deemed extended for a period equal to any delay resulting.

5.2 THE LIABILITY OF UNIPAC ARISING OUT OF THIS AGREEMENT OR ANY GOODS SOLD WILL BE LIMITED TO REFUND OF THE PURCHASE PRICE OR (WITH UNIPAC'S PRIOR WRITTEN CONSENT) REPAIR OR REPLACEMENT OF PURCHASED GOODS (RETURNED TO UNIPAC FREIGHT PRE-PAID); OR IN THE EVENT OF A FAILURE OR BREACH BY UNIPAC REGARDING DELIVERY, AN AMOUNT EQUAL TO THE TOTAL PURCHASE PRICE OF THE GOODS THAT HAVE NOT BEEN DELIVERED DUE TO SUCH FAILURE.

5.3 Buyer will not return any goods without first obtaining a customer return order number.

5.4 AS A SEPARATE LIMITATION, IN NO EVENT WILL UNIPAC BE LIABLE (i) FOR COSTS OF SUBSTITUTE GOODS, (ii) FOR ANY SPECIAL, CONSEQUENTIAL, INCIDENTAL, RELIANCE OR INDIRECT DAMAGES, OR (iii) FOR LOSS OF USE, OPPORTUNITY, MARKET POTENTIAL, GOODWILL AND/OR PROFIT ON ANY THEORY (CONTRACT, TORT, FROM THIRD PARTY CLAIMS OR OTHERWISE). THESE LIMITATIONS SHALL APPLY NOTWITHSTANDING ANY FAILURE OF ESSENTIAL PURPOSE OR OF ANY FAILURE OR INADEQUACY OF ANY REMEDY.

THIS AGREEMENT STATES THE ONLY AND EXCLUSIVE REMEDY FOR ANY AND ALL CLAIMS MADE AGAINST UNIPAC UNDER ANY AGREEMENT AND/OR WITH RESPECT TO PANELS, COMPONENTS, SERVICES AND/OR GOODS.

5.5 No action or proceeding may be commenced by either party against the other (other than to collect money due for goods delivered or services rendered), whether for breach, indemnification, contribution or otherwise, more than one year after delivery of the goods to the carrier; and no claim may be brought unless the non-claiming party has first been given commercially reasonable notice, a full written explanation of all pertinent details (including copies of all materials), and a good faith opportunity to resolve the matter.

5.6 BUYER EXPRESSLY AGREES TO THE LIMITATIONS OF ARTICLES 5, 8 AND 9 AND TO THEIR REASONABLENESS.

5.7 The exclusions and limitations of Articles 5, 8 and 9 will survive the termination of the applicable Agreements, and shall apply notwithstanding any claim of a failure of any one or more remedies to accomplish their purpose, and THE PARTIES EXPRESSLY WAIVE AND RELINQUISH ANY CONTRARY RIGHTS UNDER ANY AGREEMENT, AND/OR LAW, DECISION, CUSTOM OR PRACTICE.

6 SUBSTITUTIONS AND MODIFICATIONS

Unipac may at any time make substitutions for product ordered which do not materially and adversely affect overall performance with the then current specifications in the typical and intended use. Unipac reserves the right to halt deliveries and shipments and alter specifications and prices without notice. Buyer shall verify that the literature and information is current before purchasing. Other changes to process and/or specifications by Unipac shall be pursuant to Unipac's standard ECN procedures.

7 CANCELLATION

7.1 This Agreement may not be canceled by Buyer except with written consent by Unipac and Buyer's payment of reasonable cancellation charges (including but not be limited to expenses already incurred for labor and material, overhead, commitments made by Unipac, and a reasonable profit).

7.2 In no event will Buyer have rights in partially completed goods.

8 INDEMNIFICATION

8.1 Unipac will, at its own expense, assist Buyer with technical support and information in connection with any claim that any parts as shipped by Unipac under this purchase order infringe any valid, enforceable, unexpired R.O.C. patent, copyright, or trademark, provided however, that Buyer (i) gives immediate written notice to Unipac, (ii) permits Unipac to participate and to defend if Unipac requests to do so, and (iii) gives Unipac all needed information, assistance and authority. However, Unipac will not be responsible for infringements resulting from anything not entirely manufactured by Unipac, or from any combination with products, equipment, or materials not furnished by Unipac. Unipac will have no liability with respect to intellectual property matters arising out of products made to Buyer's specifications, code, or designs.

8.2 Except as expressly stated in this Article 8 or in another writing signed by an authorized officer, Unipac makes no representations and/or warranties with respect to intellectual and/or industrial property and/or with respect to claims of infringement.

8.3 Except as to claims Unipac agrees in writing to defend, BUYER WILL INDEMNIFY, DEFEND AND HOLD HARMLESS UNIPAC FROM ALL CLAIMS, COSTS, LOSSES, AND DAMAGES (INCLUDING ATTORNEYS' FEES) AGAINST AND/OR ARISING OUT OF GOODS SOLD AND/OR SHIPPED HEREUNDER.

9 NO CONFIDENTIAL INFORMATION

Unipac shall have no obligation to hold any information in confidence except as provided in a separate non-disclosure agreement signed by both parties.

10 ENTIRE AGREEMENT

These terms and conditions are the entire agreement between Unipac and Buyer, and no addition, deletion or modification shall be binding on Unipac unless expressly agreed to in a writing signed by an officer of Unipac. Buyer is not relying upon any warranty or representation except for those specifically stated here.

11 APPLICABLE LAW

This Agreement and all performance and disputes arising out of or relating to goods involved will be governed by the laws of Taiwan, Republic of China, without reference to conflict of laws principles and excluding the U.N. Convention on Contracts for the International Sale of Goods. Buyer agrees at its sole expense to comply with all applicable laws in connection with the purchase, use or sale of the goods provided hereunder.

12 DISPUTE RESOLUTION

12.1 Buyer and Unipac shall cooperate and attempt in good faith to resolve any and all disputes arising out of and/or relating to this Agreement and/or goods furnished pursuant to this Agreement.

12.2 Any disputes relating to and/or arising out of any Agreement and/or goods furnished pursuant to this Agreement that cannot be so resolved will be decided exclusively by binding arbitration. Such arbitration shall take place in Taipei, Taiwan pursuant to the Rules for International Arbitrations under the American Arbitration Association.

12.3 Notwithstanding anything to the contrary, any party may apply to any court of competent jurisdiction for interim injunctive relief with respect to irreparable harm which cannot be avoided and/or compensated by such arbitration proceedings, without breach of this Article 12 and without any abridgment of the powers of the arbitrators.

13 ATTORNEYS' FEES

Reasonable attorneys' fees and costs will be awarded to the prevailing party in the event of litigation involving the enforcement or interpretation of this Agreement.

Unipac Optoelectronics Corp.

**No.5, Li-Hsin Road 6 ,
Science-Based Industrial Park,
Hsin-Chu City, Taiwan, R.O.C.**

**Fax:886-3-5772545
Tel :886-3-5632899**