

Spec. No. 413-212-086

Version : 2

Total pages : 16

Date : 2001.02.21

UNIPAC 14.1" COLOR TFT-LCD MODULE**TENTATIVE SPECIFICATION****MODEL NAME: UB141X02**

The content of this technical information is subject to change without notice. Please contact Unipac or its agent for further information.

Approved by	Checked by	Prepared by
<i>F.C. Su</i>	<i>T.P. Chiang</i>	<i>Eric Lo</i>

Contents:

A. Physical specification	P2
B. Electrical specifications	P3
1. Pin assignment.....	P3
2. Absolute maximum ratings.....	P4
3. Electrical characteristics.....	P5
a. Typical operating conditions.....	P5
b. Display color v.s. input data signals.....	P6
c. Input signal timing.....	P7
d. Display position.....	P8
e. Backlight unit.....	P9
C. Optical specifications	P10
D. Reliability test items	P12
E. Display quality	P12
F. Handling precaution	P12
G. Packing form	P13
Appendix:	
Fig.1-(a) LCM outline dimensions(Front side).....	P14
Fig.1-(b) LCM outline dimensions (Back side).....	P15
Fig.2 Timing chart.....	P16

A. Physical specifications

NO.	Item	Specification	Remark
1	Display resolution(pixel)	1024(H)× 768(V)	
2	Active area(mm)	285.7(H)× 214.3(V)	
3	Screen size(inch)	14.1(Diagonal)	
4	Pixel pitch(mm)	0.279(H)× 0.279(V)	
5	Color configuration	R. G. B. Vertical stripe	
6	Overall dimension(mm)	299(W)× 228(H)× 6.0 max(D)	Note 1
7	Weight(g)	480 ± 10	
8	Surface treatment	Hard coating(3H), anti-glare of the front polarizer (12%)	

Note 1: Refer to Fig. 1.

B. Electrical specifications

1. Pin assignment

(1). Input signal interface

CN1 (20P) connector : FI-SEB-20P-HF10(JAE)

Pin no	Symbol	Function	Etc.
1	V _{CC}	Power supply ,3.3 V (typical)	
2	V _{CC}	Power supply ,3.3 V (typical)	
3	GND	Ground	
4	GND	Ground	
5	RxIN0-	-LVDS differential data input (R0-R5,G0)	
6	RxIN0+	+LVDS differential data input (R0-R5,G0)	
7	GND	Ground	
8	RxIN1-	-LVDS differential data input (G1-G5,B0-B1)	
9	RxIN1+	+LVDS differential data input (G1-G5,B0-B1)	
10	GND	Ground	
11	RxIN2-	-LVDS differential data input (B2-B5, HS, VS, DE)	
12	RxIN2+	+LVDS differential data input (B2-B5, HS, VS, DE)	
13	GND	Ground	
14	CKIN-	Clock Signal(-)	
15	CKIN+	Clock Signal(+)	
16	GND	Ground	
17	(V _{EDID})	(DDC 3.3V power)	
18	NC	Reserved for supplier test point	
19	(Clk _{EDID})	(DDC Clock)	
20	(DATA _{EDID})	(DDC Data)	

(2) LVDS channel interface data mapping diagram

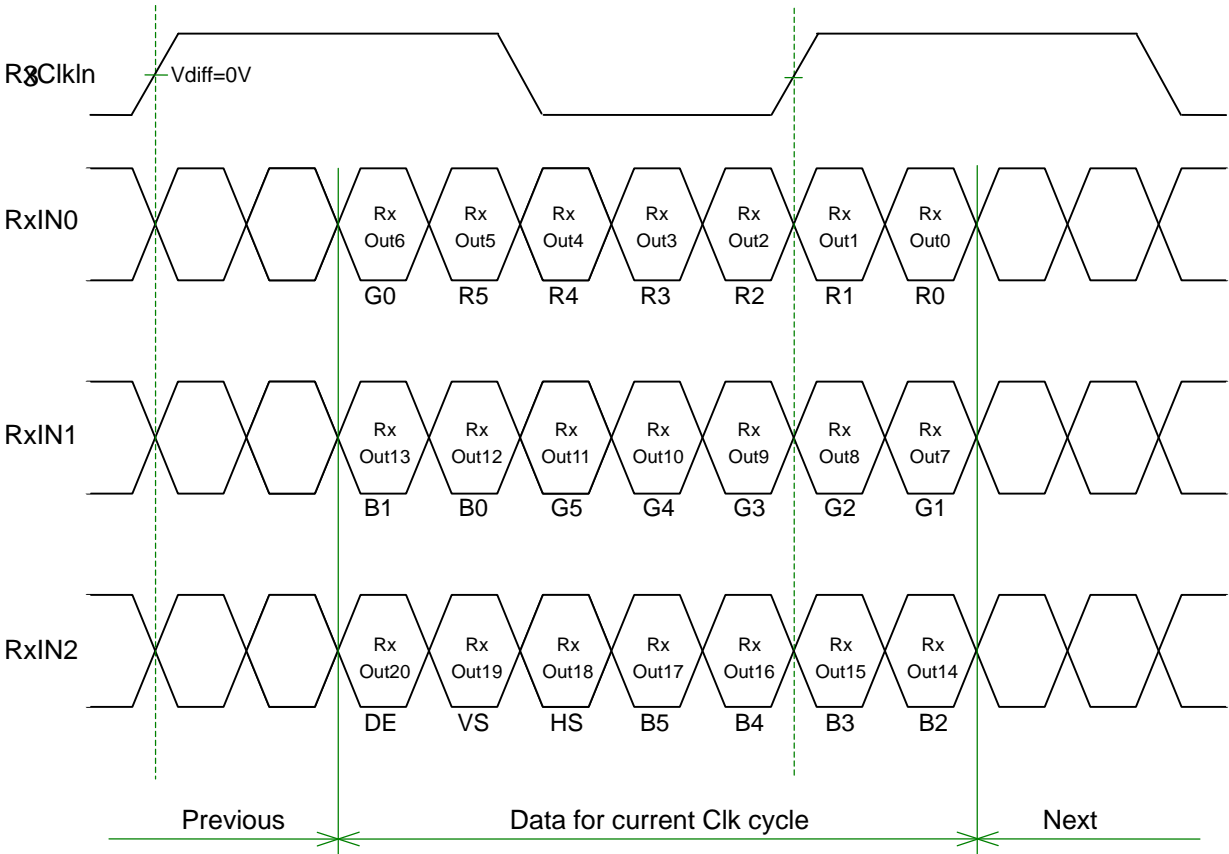

2. Absolute maximum ratings

(GND = 0 V)

Parameter	Symbol	Values		Unit	Remark
		Min.	Max.		
Power voltage	V_{CC}	-0.3	4	V_{DC}	At 25°C
Input signal voltage	V_{LH}	-0.3	$V_{CC}+0.3$	V_{DC}	At 25°C
Operating temperature	T_{op}	0	+50	°C	Note 1
Storage temperature	T_{ST}	-20	+60	°C	Note 1

Note 1: The relative humidity must not exceed 90% non-condensing at temperatures of 40°C or less. At temperatures greater than 40°C, the wet bulb temperature must not exceed 39°C. When operate at low temperatures, the brightness of CCFL will drop and the life time of CCFL will be reduced.

Note 2: The unit should not be exposed to corrosive chemicals.

3. Electrical characteristics

a. Typical operating conditions

Item	Symbol	Min.	Typ.	Max.	Unit	Remark	
Power supply voltage	Input voltage	V_{CC}	3.0	3.3	3.6	V	
	Current consumption	I_A	-	350	-		Note 1
		I_B	-	-	550	mArms	
Inrush current	I_{RUSH}	-	-	1800	mApeak	Note 2	
Internal logic	Low voltage	V_{IL}	0	-	$0.3 V_{CC}$		
	High voltage	V_{IH}	$0.7V_{CC}$	-	V_{CC}		
Power ripple voltage	V_{RP}	-	-	100	mVp-p		

Note 1: Effective value (mArms) at $V_{CC} = 3.3 V/25^{\circ}C$.

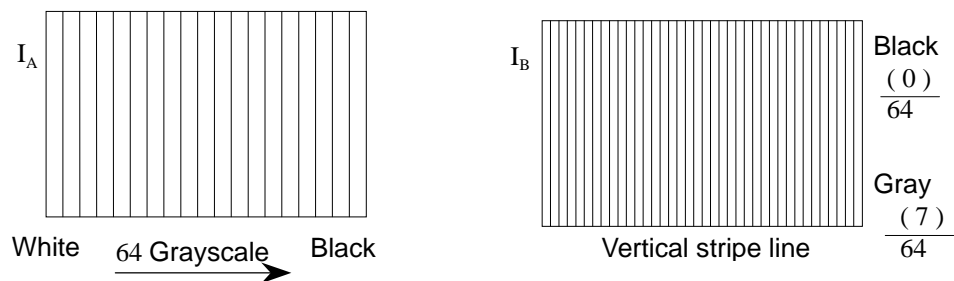

Note 2: Refer to the following power-on condition.

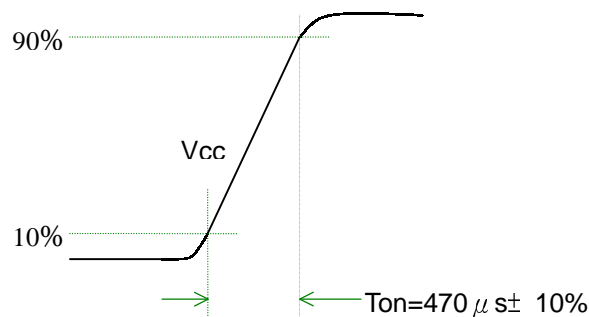

Sequence of Power-on/off and signal-on/off

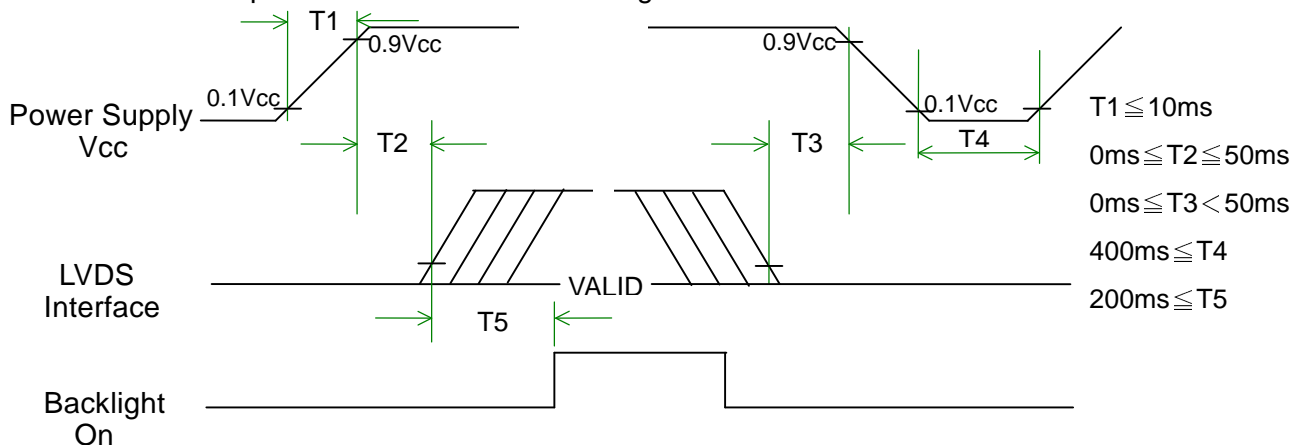

Apply the lamp voltage within the LCD operating range. When the backlight turns on before the LCD operation or the LCD turns off before the backlight turns off, the display may momentarily become abnormal.

Caution

The above on/off sequence should be applied to avoid abnormal function in the display.

In case of handling:

Make sure to turn off the power when you plug the cable into the input connector or pull the cable out of the connector.

b. Display color v.s. input data signals

Display colors		Data signal (0 : Low level, 1: High level)																	
		R5	R4	R3	R2	R1	R0	G5	G4	G3	G2	G1	G0	B5	B4	B3	B2	B1	B0
Basic colors	Black	0	0	0	0	0	0	0	0	0	0	0	0	0	0	0	0	0	0
	Blue	0	0	0	0	0	0	0	0	0	0	0	0	1	1	1	1	1	1
	Red	1	1	1	1	1	1	0	0	0	0	0	0	0	0	0	0	0	0
	Magenta	1	1	1	1	1	1	0	0	0	0	0	0	1	1	1	1	1	1
	Green	0	0	0	0	0	0	1	1	1	1	1	1	0	0	0	0	0	0
	Cyan	0	0	0	0	0	0	1	1	1	1	1	1	1	1	1	1	1	1
	Yellow	1	1	1	1	1	1	1	1	1	1	1	1	0	0	0	0	0	0
	White	1	1	1	1	1	1	1	1	1	1	1	1	1	1	1	1	1	1
Red grayscale	Black	0	0	0	0	0	0	0	0	0	0	0	0	0	0	0	0	0	0
	Dark	0	0	0	0	0	1	0	0	0	0	0	0	0	0	0	0	0	0
	↑																		
	↓																		
	bright	1	1	1	1	0	1	0	0	0	0	0	0	0	0	0	0	0	0
	Red	1	1	1	1	1	1	0	0	0	0	0	0	0	0	0	0	0	0
Green grayscale	Black	0	0	0	0	0	0	0	0	0	0	0	0	0	0	0	0	0	0
	Dark	0	0	0	0	0	0	0	0	0	0	0	1	0	0	0	0	0	0
	↑																		
	↓																		
	bright	0	0	0	0	0	0	1	1	1	1	0	1	0	0	0	0	0	0
	Green	0	0	0	0	0	0	1	1	1	1	1	1	0	0	0	0	0	0
Blue grayscale	Black	0	0	0	0	0	0	0	0	0	0	0	0	0	0	0	0	0	0
	Dark	0	0	0	0	0	0	0	0	0	0	0	0	0	0	0	0	1	0
	↑																		
	↓																		
	bright	0	0	0	0	0	0	0	0	0	0	0	0	1	1	1	1	0	1
	Blue	0	0	0	0	0	0	0	0	0	0	0	0	1	1	1	1	1	0
Blue	0	0	0	0	0	0	0	0	0	0	0	0	1	1	1	1	1	1	

Note : Each basic color can be displayed in 64 gray scales using the 6 bit data signals. By combining the 18-bit data signals(R,G,B), the 262,144 colors can be achieved on the display.

c. Input signal timing

Timing diagrams of input signal are shown in Fig 2.

(1). Timing characteristics of input signals

	Item	Symbol	Min.	Typ.	Max.	Unit	Remark
CLK clock	Frequency	Fck	50	65	66	MHz	
	Period	Clk	15.2	15.4	20	ns	
Hs Horizontal sync	Period	Th	1040	1344	1648	Clk	
			20	20.7	-	μs	
	Display period	Thd	1024			Clk	
	Pulse width	Thw	2	136	-	Clk	
	Display start	The	296	296	296	Clk	DE non-using
			8	296	600	Clk	DE using
	Front porch	Thf	8	24	-	Clk	
	Back porch	Thb	4	160	-	Clk	
	Blanking	Thb1	16	320	624	Clk	
Vs Vertical sync	Phase shift	Tvpd	2	320	-	Clk	
	Period	Tv	803	806	895	Th	
			-	16.6	20	ms	
	Display width	Tvd	768			Th	
	Pulse width	Tvw	1	6	-	Th	
	Display start	Tve	-	35	-	Th	DE non-using
	Front porch	Tvf	0	3	-	Th	
Blanking	Tvb1	35	38	127	Th		

Available data input timing

Horizontal	DE non-using	When DE signal is fixed Low, after falling edge of Hs, counting 296 clocks, then getting valid data from 297th clock's data.
	DE using	Valid data is according to rising edge of "DE" signal. The time should be 8 to 600 clocks between falling edge of Hs and rising edge of DE.
Vertical	DE non-using	After falling edge of Vs, counting 35 Th, then getting 36th Th's data. (in DE non-using mode and DE using mode).
	DE using	Valid data is according to the first rising edge of "DE" signal after DE keeps low during blanking period.

(2). The timing condition of LVDS

Item	Symbol	Min.	Typ.	Max.	Unit
The differential level	VID	0.1	-	0.6	V
The common mode input voltage	VIC	$\frac{ VID }{2}$	-	$2.4 - \frac{ VID }{2}$	V
The input setup time	tsu1	500	-	-	ps
The input hold time	th1	500	-	-	ps

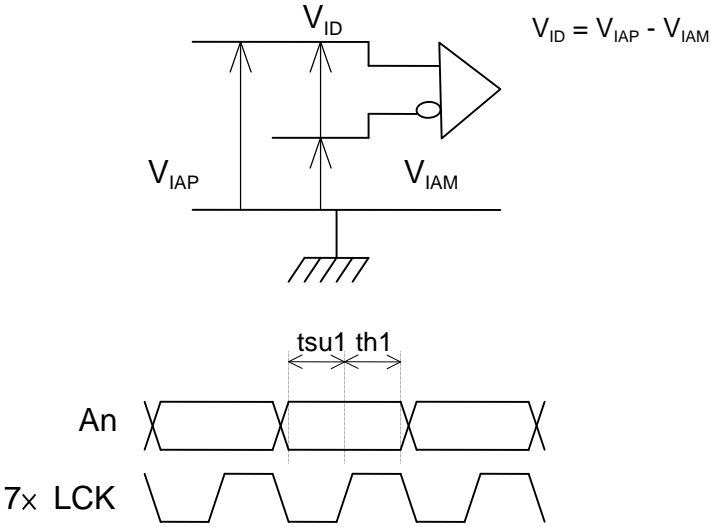

d. Display position

D(1,1)	D(2,1)	D(X,1)	D(1023,1)	D(1024,1)
D(1,2)	D(2,2)	D(X,2)	D(1023,2)	D(1024,2)
⋮		⋮	⋮	⋮
D(1,Y)	D(2,Y)	D(X,Y)	D(1023,Y)	D(1024,Y)
⋮		⋮	⋮	⋮
D(1,767)	D(2,767)	D(X,767)	D(1023,767)	D(1024,767)
D(1,768)	D(2,768)	D(X,768)	D(1023,768)	D(1024,768)

e. Backlight unit

The backlight system is an edge-lighting type with a CCFT(Cold Cathode Fluorescent Tube).

The characteristics of a single lamp are shown in the following tables.

Parameter	Symbol	Min.	Typ.	Max.	Unit	Remark
Lamp voltage	V_L	594	660	726	Vrms	Note 1
Lamp current	I_L	3	6	6.5	mArms	Note 1
Power consumption	P_L		3.96		W	Note 2
Lamp starting voltage	V_s		-	1530 (T=0°C)	Vrms	Note 3
			-	1250(T=25°C)		
Frequency	F_L	50	60	80	KHz	Note 4
Lamp life time	L_L	10000	-	-	Hr	Note 1, 5

Note 1: T= 25°C

Note 2: Inverter should be designed with the characteristic of lamp. When you are designing the inverter, the output voltage of the inverter should comply with the following conditions.

- (1). The area under the positive and negative cycles of the waveform of the lamp current and lamp voltage should be area symmetric(the symmetric ratio should be larger than 90%).
- (2). There should not have any spikes in the waveform.
- (3). The waveform should be sine wave as possible.
- (4). Lamp current should not exceed the maximum value within the operating temperature (It is prohibited to over the maximum lamp current even if operated in the non-guaranteed temperature). When lamp current over the maximum value for a long time, it may cause fire. Therefore, it is recommend that the inverter should have the current limited circuit.

Note 3: The inverter open voltage should be designed larger than the lamp starting voltage at T=0°C, otherwise backlight may be blinking for a moment after turning on or not be able to turn on. The open voltage should be measured after ballast capacitor. If an inverter has shutdown function it should keep its open voltage for longer than 1 second even if lamp connector is open.

Note 4: Lamp frequency may produce interference with horizontal synchronous frequency and this may cause line flow on the display. Therefore lamp frequency shall be detached from the horizontal synchronous frequency and its harmonics as far as possible in order to avoid interference. In case using the inverter by PWM control, PWM frequency may interference with frame frequency. We suggest that PWM frequency is same as frame frequency.

Note 5: Brightness to be decrease to the 50% of the initial value under $I_L = 6mA$.

Note 6: CN2 connector (backlight): BHSR-02VS-1(JST).

Mating connector: SM02B-BHSS-1-TB (JST).

Pin no.	Symbol	Function	Remark
1	H	CCFL power supply(H.V.)	Cable color: Pink
2	L	CCFL power supply(GND)	Cable color: White

C. Optical specifications (Note 1, Note 2)

Item	Symbol	Condition	Specification			Unit	Remark
			Min.	Typ.	Max.		
Response time Rising time Falling time	Tr Tf	$\theta = 0^\circ$	- -	20 30	40 50	ms	Note 4
Contrast ratio	CR	$\theta = 0^\circ$	150	200	-		Note 3,5
Viewing angle Top Bottom Left Right		$CR \geq 10$	15 35 40 40	- - - -	- - - -	deg.	Note 3,8
Brightness	5 points	Y_L	$\theta = 0^\circ$	130	150	-	Note 3,6,7,9
Color chromaticity(CIE)	Wx	$\theta = 0^\circ$	0.280	0.310	0.340		
	Wy		0.300	0.330	0.360		
	Rx		0.547	0.577	0.607		
	Ry		0.298	0.328	0.358		
	Gx		0.270	0.300	0.330		
	Gy		0.545	0.575	0.605		
	Bx		0.115	0.145	0.175		
	By		0.090	0.120	0.150		
White uniformity	δ_w		-	-	1.8		Note 3,9

Note 1: Ambient temperature = 25°C .

Note 2: To be measured in dark room after lighting the backlight for 30 minutes.

Note 3: To be measured with a viewing cone of 1° by Topcon luminance meter BM-5A.

Note 4: Definition of response time:

The output signals of BM-7 are measured when the input signals are changed from "Black" to "White" (falling time) and from "White" to "Black" (rising time), respectively. The response time interval between the 10% and 90% of amplitudes. Refer to figure as below.

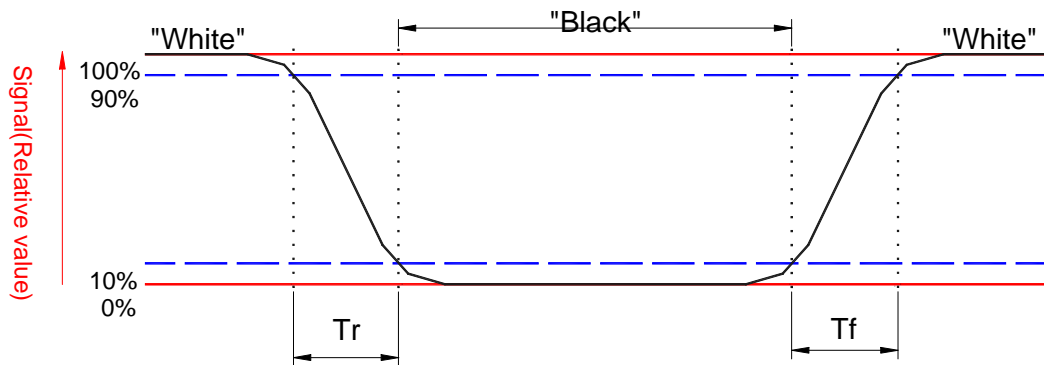

Note 5. Definition of contrast ratio:

Contrast ratio is calculated with the following formula.

$$\text{Contrast ratio (CR)} = \frac{\text{Brightness on the "White" state}}{\text{Brightness on the "Black" state}}$$

Note 6: Definition of brightness:

$$\text{Brightness}(Y_L) = \frac{Y_{LD} + Y_{LE} + Y_{LG} + Y_{LI} + Y_{LJ}}{5}$$

Note 7: Driving conditions for CCFL : I_L=6.0 mA, 60Hz frequency.

Note 8: Definition of viewing angle

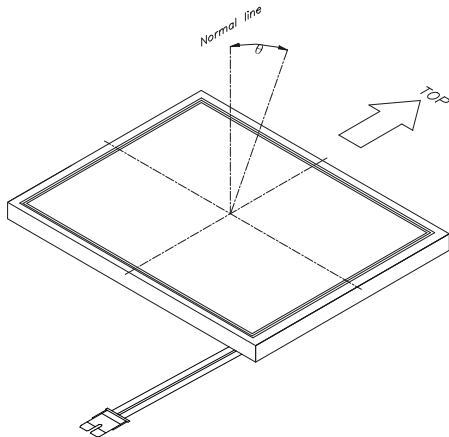

Note 9: Definition of white uniformity:

White uniformity is defined as the following with thirteen measurements (A~M).

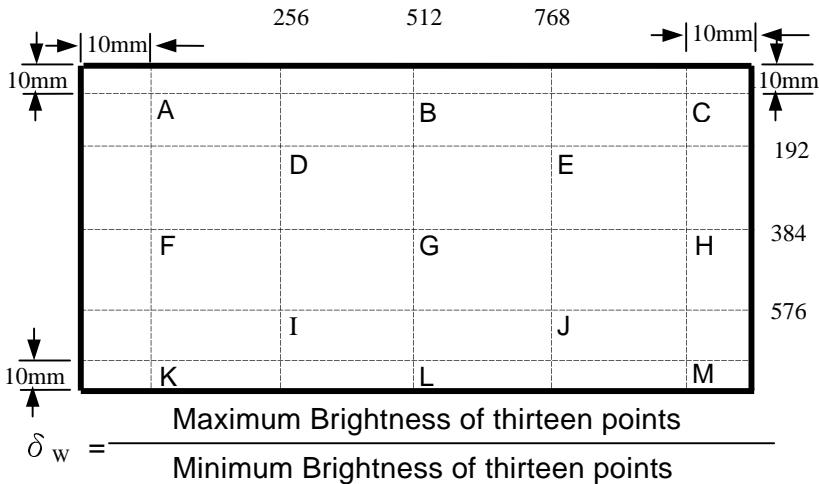

D. Reliability test items(Note 1)

Test tem	Test Condition	Judgement	Remark
High temperature storage	60°C, 240Hrs	Display quality	Note 1, 2
Low temperature storage	-20°C, 240Hrs	Display quality	Note 1, 2
High temperature & high humidity operation	40°C, 90%RH, 240Hrs (No condensation)	Display quality	Note 1, 2
High temperature operation	50°C, 240Hrs	Display quality	Note 1, 2
Low temperature operation	0°C, 240Hrs	Display quality	Note 1, 2
Temperature cycling (non-operation)	-20°C ~ 60°C 1Hr, 10mins, 1Hr, 5cycles	Display quality	Note 1, 2
Electrostatic discharge (non-operation)	150PF, 150Ω, ± 10KV, 1second, 9 points on the panel, 10 times each place	Display function	Note 3
Vibration (non-operation)	Sweep:1G, 10Hz ~ 500Hz ~ 10Hz/2.5min 2 hour for each direction X, Y, Z (6 Hrs in total)	Display quality	Note 1, 2
Mechanical shock (non-operation)	Half-Sine Wave, 220G, ± X, ± Y, ± Z once for each direction	Display quality	Note 1, 2

Note 1: Evaluation should be tested after storage at room temperature for one hour.

Note 2: There should be no change which might affect the practical display function when the display quality test is conducted under normal operating condition.

Note 3: The discharging points are shown as below.

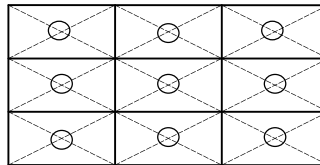

E. Display quality

The display quality of the color TFT-LCD module should be in compliance with the Unipac's incoming inspection standard.

F. Handling precaution

The Handling of the TFT-LCD should be in compliance with the Unipac's handling principle standard.

G. Packing form

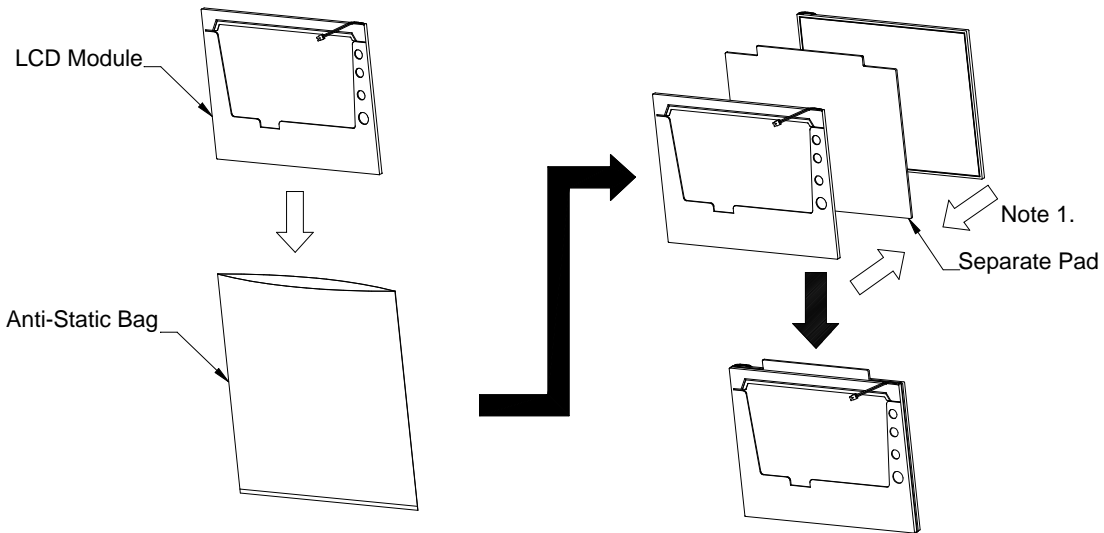

Note :

1. The panel of each LCD Module faces toward separation pad.
2. Max. capacity : 20 LCD Modules/Carton.
3. Max. weight : 15kg/Carton.
4. Meas. : 458mm*412mm*365mm.

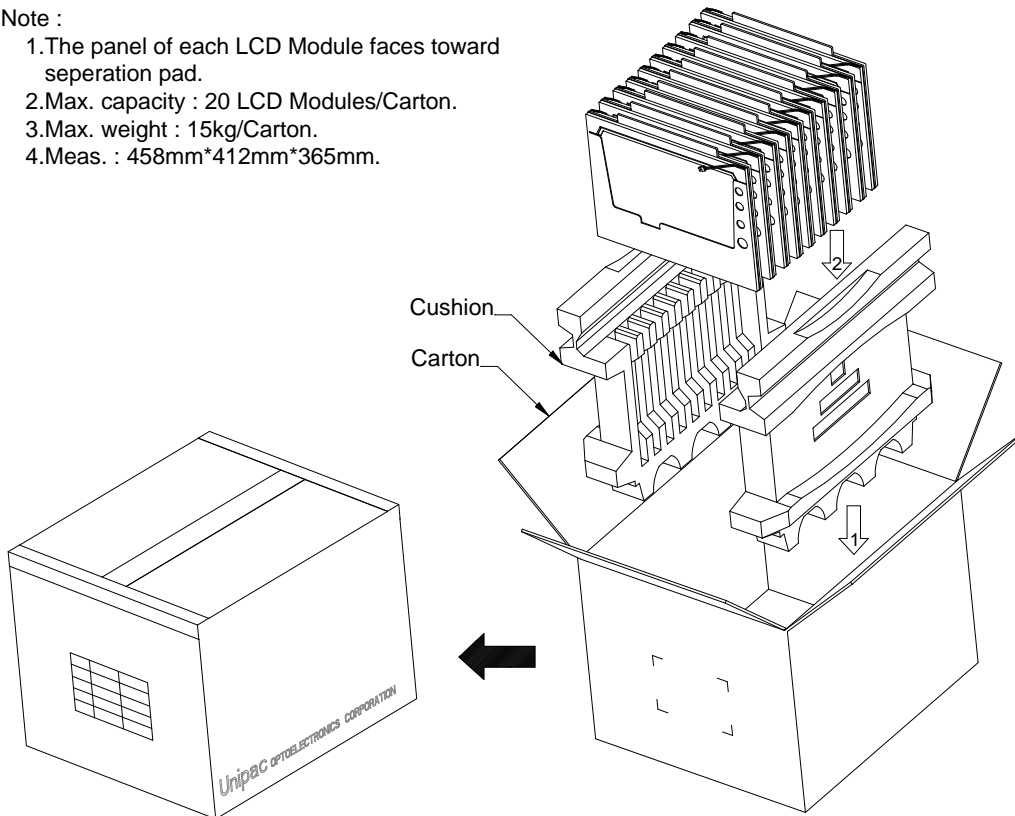

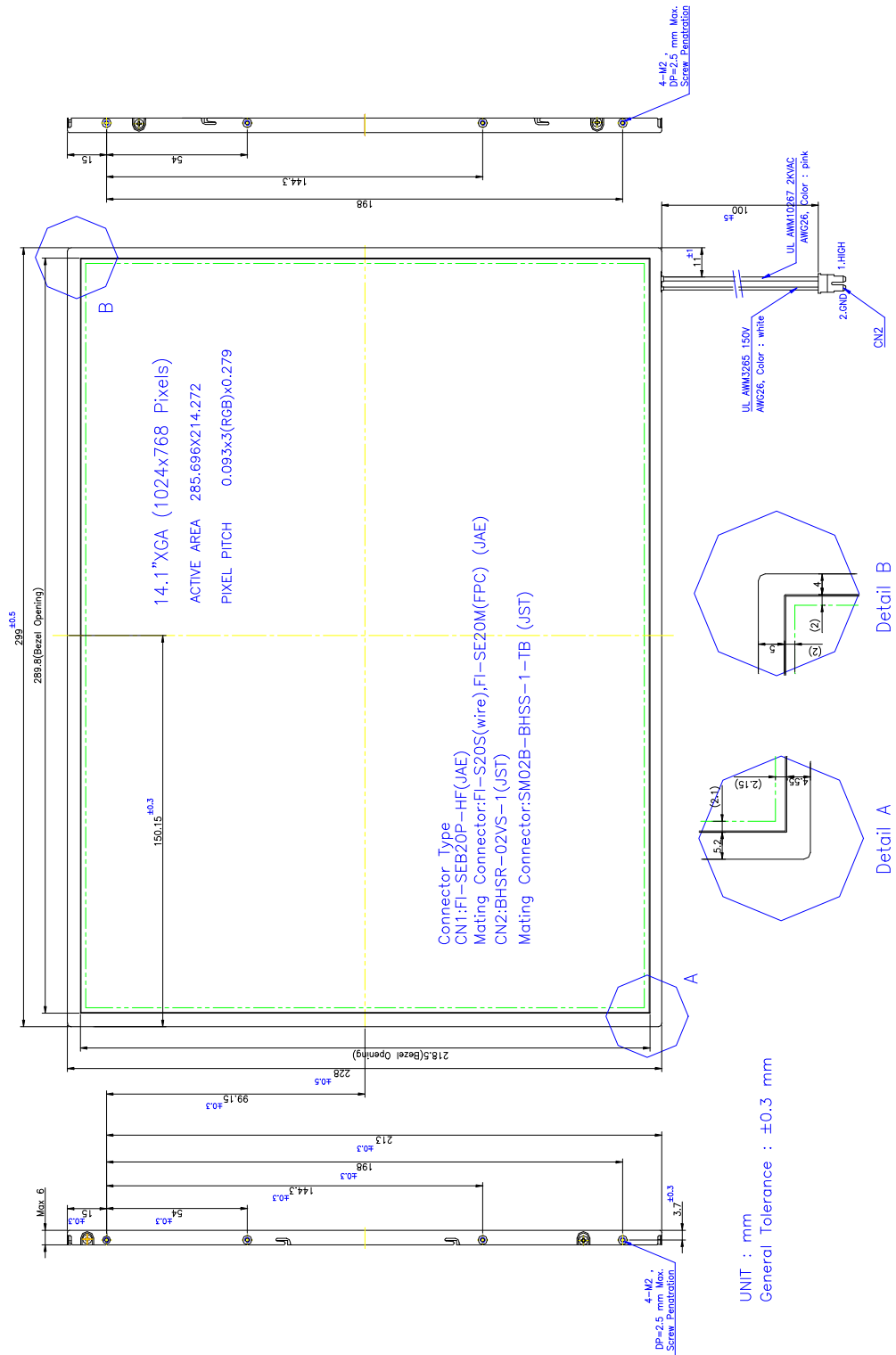

Fig.1-(a) LCM outline dimensions (Front side)

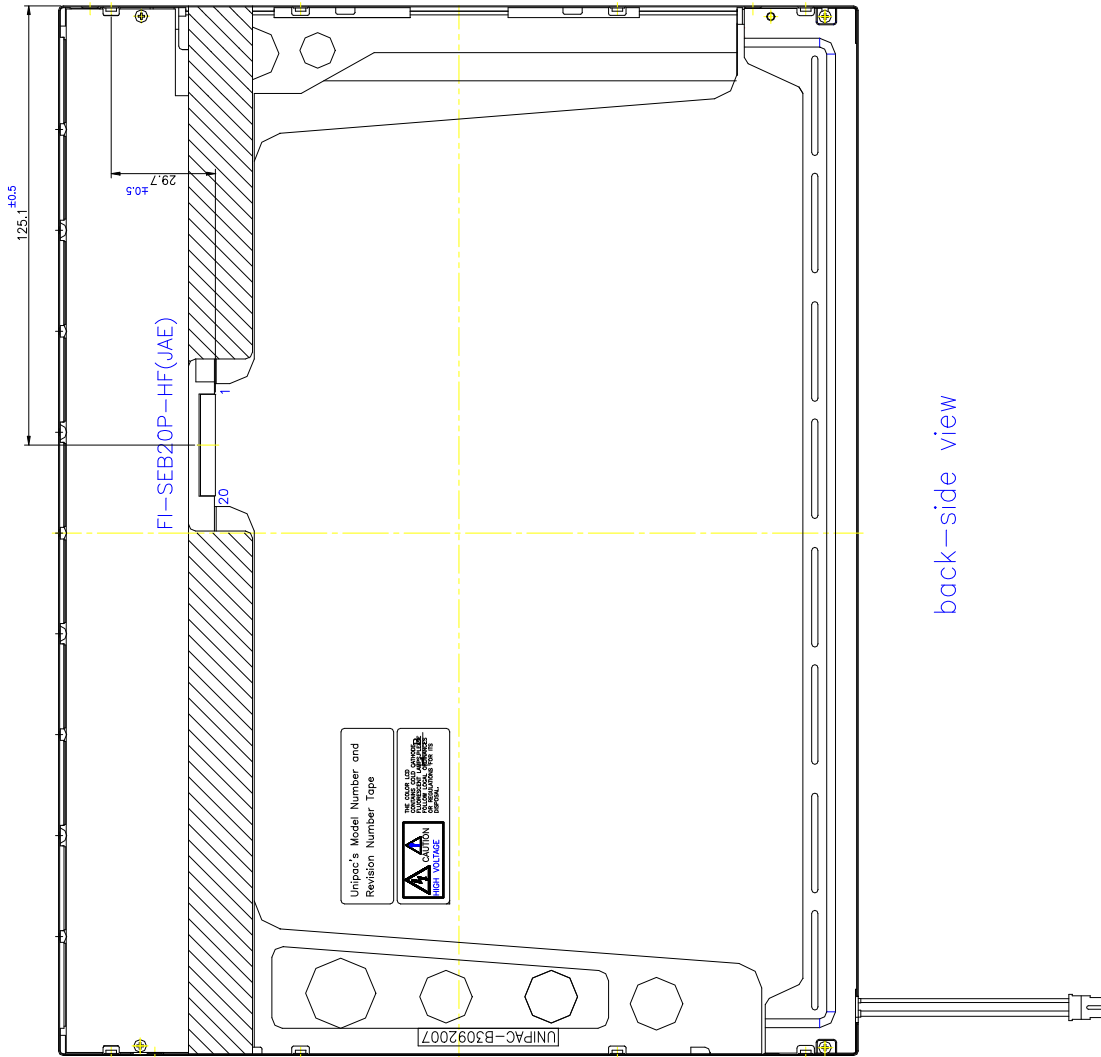

Fig.1-(b) LCM outline dimensions (Back side)

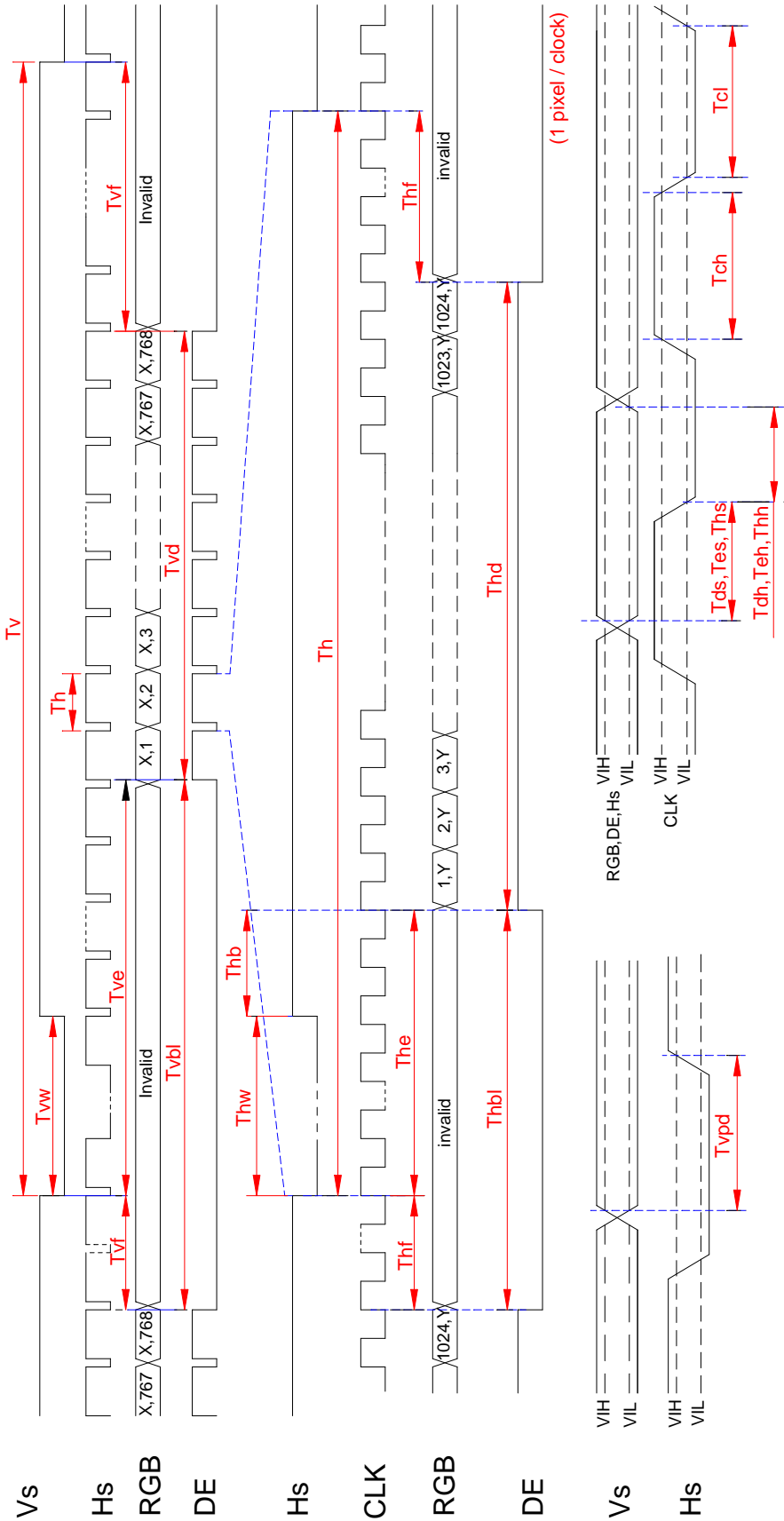

Fig.2 Timing chart

UNIPAC OPTOELECTRONICS CORPORATION

TERMS AND CONDITIONS OF SALE

These Terms and Conditions of Sale apply to all items designed and/or made by Unipac Optoelectronics Corporation ("Unipac"), and Buyer agrees they apply to all such items.

1 ACCEPTANCE OF TERMS. BUYER ACCEPTS THESE TERMS (i) BY WRITTEN ACCEPTANCE (BY PURCHASE ORDER OR OTHERWISE), OR (ii) BY FAILURE TO RETURN GOODS SUPPLIED BY UNIPAC WITHIN 5 DAYS OF THEIR DELIVERY.

2 DELIVERY

2.1 Delivery will be made Free Carrier (Incoterms 1990), Unipac's warehouse, Science-Based Industrial Park, Taiwan to a carrier designated in writing by Buyer, or if Buyer fails to designate a carrier, to a carrier designated by Unipac.

2.2 Title to the goods and the entire risk will pass to Buyer upon delivery to carrier.

2.3 Shipments are subject to availability. Unipac shall make every reasonable effort to meet the date(s) quoted or acknowledged; and if Unipac makes such effort, UNIPAC WILL NOT BE LIABLE FOR ANY DELAYS.

3 TERMS OF PAYMENT

3.1 Unless otherwise stated on Unipac's quotation, all shipments shall be T/T in advance, by Letter of Credit at Sight, or pursuant to agreed prepayment terms. Unipac reserves the right to change credit terms at any time in its sole discretion.

3.2 Buyer guarantees prompt payment of all obligations accrued pursuant to purchase orders issued by Buyer.

4 LIMITED WARRANTY

4.1 Unipac warrants that the goods sold will be free from defects in material and workmanship and comply with Unipac's applicable published specifications for a period of sixty (60) days from the date of Unipac's shipment.

4.2 Goods or parts which have been subject to abuse (including without limitation repeated or extended exposure to conditions at or near the limits of applicable absolute ratings) misuse, accident, alteration, neglect, or unauthorized repair or improper application are not covered by any warranty. No warranty is made with respect to custom products or goods produced to Buyer's specifications (unless specifically stated in writing signed by Unipac). Unipac shall not be responsible for defects or claims caused by acts not performed by Unipac; or by combination of goods with other things.

4.3 No warranty is made with respect to goods used in devices intended for use in applications where failure to perform when properly used can reasonably be expected to result in significant injury (including, without limitation, navigation, aviation, weaponry or nuclear equipment, or for surgical implant or to support or sustain life) and Buyer agrees to indemnify, defend, and hold harmless Unipac from all claims, damages and liabilities arising out of any such uses.

4.4 This Article 4 is the only warranty by Unipac with respect to goods and may not be modified or amended except in writing signed by an authorized officer of Unipac.

4.5 Buyer acknowledges and agrees that it is not relying on any applications, diagrams or circuits contained in any literature, and Buyer will test all parts and applications under extended field and laboratory conditions. Notwithstanding any cross-reference or any statements of compatibility, functionality, interchangeability, and the like, the goods may differ from similar goods from other vendors in performance, function or operation, and in areas not contained in the written specifications, or as to ranges and conditions outside such specifications; and Buyer agrees that there are no warranties and that Unipac is not responsible for such things.

4.6 REGARDLESS OF CAUSE OR REASON FOR DAMAGE (WHETHER ACCIDENT, NEGLIGENCE, OR OTHERWISE) UNIPAC SHALL HAVE NO LIABILITY (DIRECT, CONSEQUENTIAL OR OTHER) FOR, IN CONNECTION WITH OR ARISING FROM PROPERTY FURNISHED FOR USE AT OR LEFT AT UNIPAC; and by delivering or entrusting property to Unipac, Buyer expressly confirms this limitation. Notwithstanding this limitation, Unipac will replace, or pay the reasonable retooling costs to replace, masks damaged or destroyed as a result of Unipac's gross negligence or fault.

4.7 EXCEPT AS PROVIDED ABOVE, UNIPAC MAKES NO WARRANTIES OR CONDITIONS, EXPRESS, IMPLIED, OR STATUTORY; AND UNIPAC EXPRESSLY EXCLUDES AND DISCLAIMS ANY WARRANTY OR CONDITION OF NON-INFRINGEMENT, MERCHANTABILITY OR FITNESS FOR PARTICULAR PURPOSE OR APPLICATION.

5 LIMITATION OF LIABILITY

5.1 Unipac will not be liable for any loss, damage or penalty resulting from causes beyond its reasonable control, including but not limited to delay by others, force majeure, acts of God, material shortage or labor conditions. In any such event, the date(s) for Unipac's performance will be deemed extended for a period equal to any delay resulting.

5.2 THE LIABILITY OF UNIPAC ARISING OUT OF THIS AGREEMENT OR ANY GOODS SOLD WILL BE LIMITED TO REFUND OF THE PURCHASE PRICE OR (WITH UNIPAC'S PRIOR WRITTEN CONSENT) REPAIR OR REPLACEMENT OF PURCHASED GOODS (RETURNED TO UNIPAC FREIGHT PRE-PAID); OR IN THE EVENT OF A FAILURE OR BREACH BY UNIPAC REGARDING DELIVERY, AN AMOUNT EQUAL TO THE TOTAL PURCHASE PRICE OF THE GOODS THAT HAVE NOT BEEN DELIVERED DUE TO SUCH FAILURE.

5.3 Buyer will not return any goods without first obtaining a customer return order number.

5.4 AS A SEPARATE LIMITATION, IN NO EVENT WILL UNIPAC BE LIABLE (i) FOR COSTS OF SUBSTITUTE GOODS, (ii) FOR ANY SPECIAL, CONSEQUENTIAL, INCIDENTAL, RELIANCE OR INDIRECT DAMAGES, OR (iii) FOR LOSS OF USE, OPPORTUNITY, MARKET POTENTIAL, GOODWILL AND/OR PROFIT ON ANY THEORY (CONTRACT, TORT, FROM THIRD PARTY CLAIMS OR OTHERWISE). THESE LIMITATIONS SHALL APPLY NOTWITHSTANDING ANY FAILURE OF ESSENTIAL PURPOSE OR OF ANY FAILURE OR INADEQUACY OF ANY REMEDY.

THIS AGREEMENT STATES THE ONLY AND EXCLUSIVE REMEDY FOR ANY AND ALL CLAIMS MADE AGAINST UNIPAC UNDER ANY AGREEMENT AND/OR WITH RESPECT TO PANELS, COMPONENTS, SERVICES AND/OR GOODS.

5.5 No action or proceeding may be commenced by either party against the other (other than to collect money due for goods delivered or services rendered), whether for breach, indemnification, contribution or otherwise, more than one year after delivery of the goods to the carrier; and no claim may be brought unless the non-claiming party has first been given commercially reasonable notice, a full written explanation of all pertinent details (including copies of all materials), and a good faith opportunity to resolve the matter.

5.6 BUYER EXPRESSLY AGREES TO THE LIMITATIONS OF ARTICLES 5, 8 AND 9 AND TO THEIR REASONABLENESS.

5.7 The exclusions and limitations of Articles 5, 8 and 9 will survive the termination of the applicable Agreements, and shall apply notwithstanding any claim of a failure of any one or more remedies to accomplish their purpose, and THE PARTIES EXPRESSLY WAIVE AND RELINQUISH ANY CONTRARY RIGHTS UNDER ANY AGREEMENT, AND/OR LAW, DECISION, CUSTOM OR PRACTICE.

6 SUBSTITUTIONS AND MODIFICATIONS

Unipac may at any time make substitutions for product ordered which do not materially and adversely affect overall performance with the then current specifications in the typical and intended use. Unipac reserves the right to halt deliveries and shipments and alter specifications and prices without notice. Buyer shall verify that the literature and information is current before purchasing. Other changes to process and/or specifications by Unipac shall be pursuant to Unipac's standard ECN procedures.

7 CANCELLATION

7.1 This Agreement may not be canceled by Buyer except with written consent by Unipac and Buyer's payment of reasonable cancellation charges (including but not be limited to expenses already incurred for labor and material, overhead, commitments made by Unipac, and a reasonable profit).

7.2 In no event will Buyer have rights in partially completed goods.

8 INDEMNIFICATION

8.1 Unipac will, at its own expense, assist Buyer with technical support and information in connection with any claim that any parts as shipped by Unipac under this purchase order infringe any valid, enforceable, unexpired R.O.C. patent, copyright, or trademark, provided however, that Buyer (i) gives immediate written notice to Unipac, (ii) permits Unipac to participate and to defend if Unipac requests to do so, and (iii) gives Unipac all needed information, assistance and authority. However, Unipac will not be responsible for infringements resulting from anything not entirely manufactured by Unipac, or from any combination with products, equipment, or materials not furnished by Unipac. Unipac will have no liability with respect to intellectual property matters arising out of products made to Buyer's specifications, code, or designs.

8.2 Except as expressly stated in this Article 8 or in another writing signed by an authorized officer, Unipac makes no representations and/or warranties with respect to intellectual and/or industrial property and/or with respect to claims of infringement.

8.3 Except as to claims Unipac agrees in writing to defend, BUYER WILL INDEMNIFY, DEFEND AND HOLD HARMLESS UNIPAC FROM ALL CLAIMS, COSTS, LOSSES, AND DAMAGES (INCLUDING ATTORNEYS' FEES) AGAINST AND/OR ARISING OUT OF GOODS SOLD AND/OR SHIPPED HEREUNDER.

9 NO CONFIDENTIAL INFORMATION

Unipac shall have no obligation to hold any information in confidence except as provided in a separate non-disclosure agreement signed by both parties.

10 ENTIRE AGREEMENT

These terms and conditions are the entire agreement between Unipac and Buyer, and no addition, deletion or modification shall be binding on Unipac unless expressly agreed to in a writing signed by an officer of Unipac. Buyer is not relying upon any warranty or representation except for those specifically stated here.

11 APPLICABLE LAW

This Agreement and all performance and disputes arising out of or relating to goods involved will be governed by the laws of Taiwan, Republic of China, without reference to conflict of laws principles and excluding the U.N. Convention on Contracts for the International Sale of Goods. Buyer agrees at its sole expense to comply with all applicable laws in connection with the purchase, use or sale of the goods provided hereunder.

12 DISPUTE RESOLUTION

12.1 Buyer and Unipac shall cooperate and attempt in good faith to resolve any and all disputes arising out of and/or relating to this Agreement and/or goods furnished pursuant to this Agreement.

12.2 Any disputes relating to and/or arising out of any Agreement and/or goods furnished pursuant to this Agreement that cannot be so resolved will be decided exclusively by binding arbitration. Such arbitration shall take place in Taipei, Taiwan pursuant to the Rules for International Arbitrations under the American Arbitration Association.

12.3 Notwithstanding anything to the contrary, any party may apply to any court of competent jurisdiction for interim injunctive relief with respect to irreparable harm which cannot be avoided and/or compensated by such arbitration proceedings, without breach of this Article 12 and without any abridgment of the powers of the arbitrators.

13 ATTORNEYS' FEES

Reasonable attorneys' fees and costs will be awarded to the prevailing party in the event of litigation involving the enforcement or interpretation of this Agreement.

Unipac Optoelectronics Corp.

**No.5, Li-Hsin Road 6 ,
Science-Based Industrial Park,
Hsin-Chu City, Taiwan, R.O.C.**

**Fax:886-3-5772545
Tel :886-3-5632899**