

PROTECTION PRODUCTS - MicroClamp[®]

Description

The μ Clamp[®] TVS diodes are designed to replace multilayer varistors (MLVs) in portable applications such as cell phones, notebook computers, and PDAs. They offer superior electrical characteristics such as lower clamping voltage and no device degradation when compared to MLVs. They are designed to protect sensitive semiconductor components from damage or upset due to electrostatic discharge (ESD), lightning, electrical fast transients (EFT), and cable discharge events (CDE).

The μ Clamp[®]3301P is constructed using Semtech's proprietary EPD process technology. The EPD process provides low standoff voltages with significant reductions in leakage currents and capacitance over silicon-avalanche diode processes. They feature a true operating voltage of 3.3 volts for superior protection when compared to traditional pn junction devices.

The μ Clamp3301P is in an 2-pin SLP1006P2 package. It measures 1.0 x 0.6 x 0.5mm. The leads are spaced at a pitch of 0.65mm and are finished with lead-free NiPdAu. Each device will protect one line operating at 3.3 volts. It gives the designer the flexibility to protect single lines in applications where arrays are not practical. They may be used to meet the ESD immunity requirements of IEC 61000-4-2, Level 4 (± 15 kV air, ± 8 kV contact discharge). The combination of small size and high ESD surge capability makes them ideal for use in portable applications such as cellular phones, digital cameras, and MP3 players.

Features

- ◆ Transient protection for data lines to **IEC 61000-4-2 (ESD)**
IEC 61000-4-4 (EFT)
Cable Discharge Event (CDE)
- ◆ Ultra-small package
- ◆ Protects one data line
- ◆ Low clamping voltage
- ◆ Working voltage: 3.3V
- ◆ Low leakage current
- ◆ Solid-state silicon-avalanche technology

Mechanical Characteristics

- ◆ SLP1006P2 package
- ◆ Pb-Free, Halogen Free, RoHS/WEEE Compliant
- ◆ Nominal Dimensions: 1.0 x 0.6 x 0.5 mm
- ◆ Lead Finish: NiPdAu
- ◆ Molding compound flammability rating: UL 94V-0
- ◆ Marking: Marking code, cathode band
- ◆ Packaging: Tape and Reel

Applications

- ◆ Cellular Handsets & Accessories
- ◆ Personal Digital Assistants (PDAs)
- ◆ Notebooks & Handhelds
- ◆ Portable Instrumentation
- ◆ Digital Cameras
- ◆ Peripherals
- ◆ MP3 Players

Dimensions

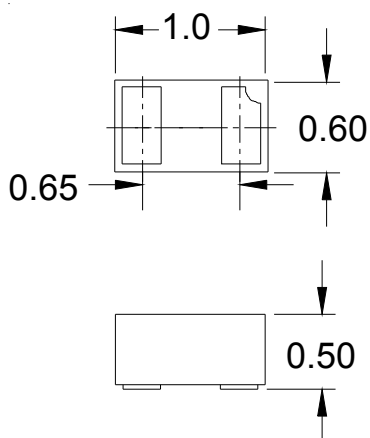

Maximum Dimensions (mm)

Schematic & PIN Configuration

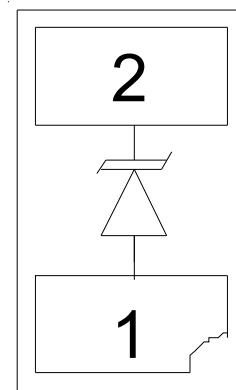

SLP1006P2 (Bottom View)

PROTECTION PRODUCTS
Absolute Maximum Rating

Rating	Symbol	Value	Units
Peak Pulse Power (tp = 8/20μs)	P_{pk}	40	Watts
Maximum Peak Pulse Current (tp = 8/20μs)	I_{pp}	5	Amps
ESD per IEC 61000-4-2 (Air) ESD per IEC 61000-4-2 (Contact)	V_{ESD}	+/- 20 +/- 15	kV
Operating Temperature	T_J	-40 to +85	°C
Storage Temperature	T_{STG}	-55 to +150	°C

Electrical Characteristics (T=25°C)

Parameter	Symbol	Conditions	Minimum	Typical	Maximum	Units
Reverse Stand-Off Voltage	V_{RWM}				3.3	V
Punch-Through Voltage	V_{PT}	$I_{PT} = 2\mu A$	3.5	3.9	4.6	V
Snap-Back Voltage	V_{SB}	$I_{SB} = 50mA$	2.8			V
Reverse Leakage Current	I_R	$V_{RWM} = 3.3V$		0.05	0.5	μA
Clamping Voltage	V_C	$I_{pp} = 1A, tp = 8/20\mu s$			5.5	V
Clamping Voltage	V_C	$I_{pp} = 5A, tp = 8/20\mu s$			8.0	V
Reverse Clamping Voltage	V_{CR}	$I_{pp} = 1A, tp = 8/20\mu s$			2.4	V
Junction Capacitance	C_J	I/O pin to Gnd $V_R = 0V, f = 1MHz$		25	30	pF
		I/O pin to Gnd $V_R = 3.3V, f = 1MHz$		14		pF

PROTECTION PRODUCTS

Typical Characteristics

Non-Repetitive Peak Pulse Power vs. Pulse Time

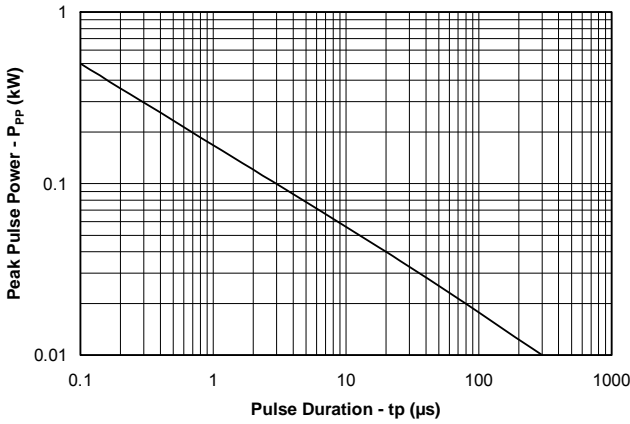

Power Derating Curve

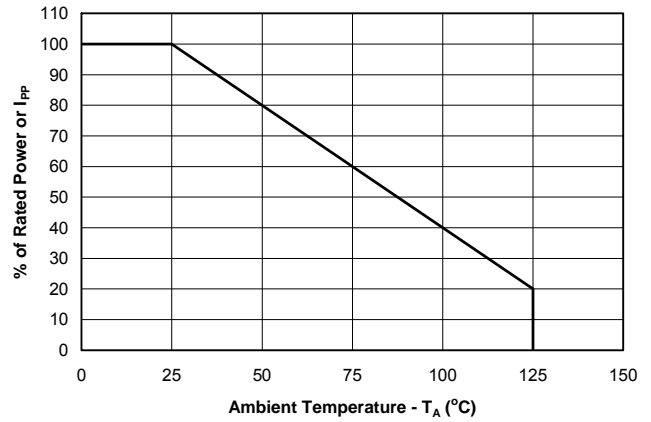

Clamping Voltage vs. Peak Pulse Current

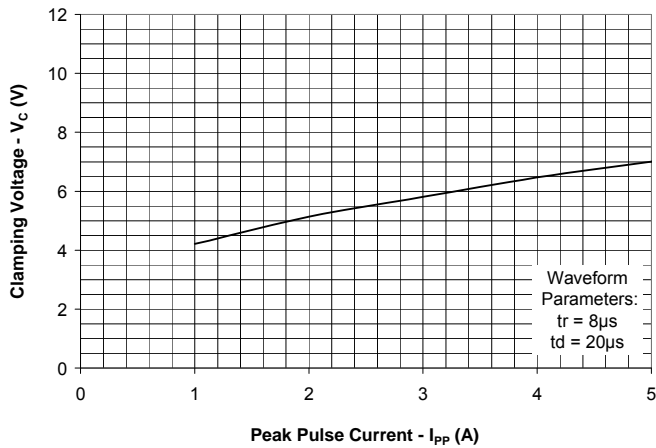

Normalized Junction Capacitance vs. Reverse Voltage

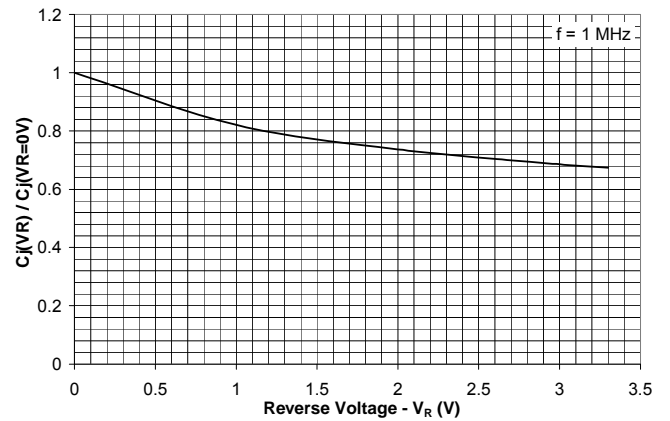

Insertion Loss S21

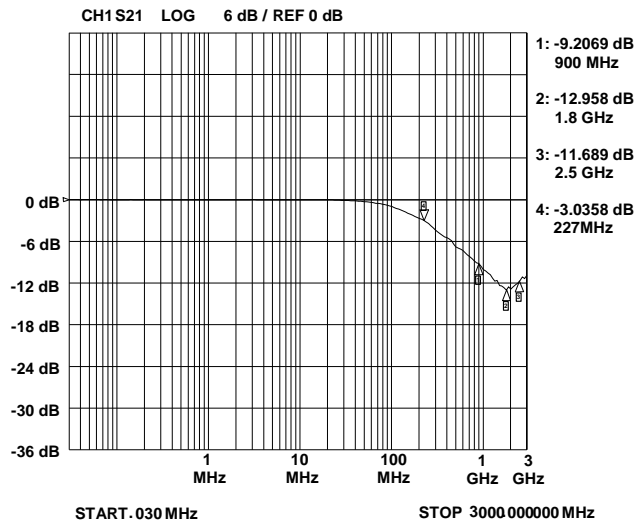

ESD Clamping (8kV Contact per IEC 61000-4-2)

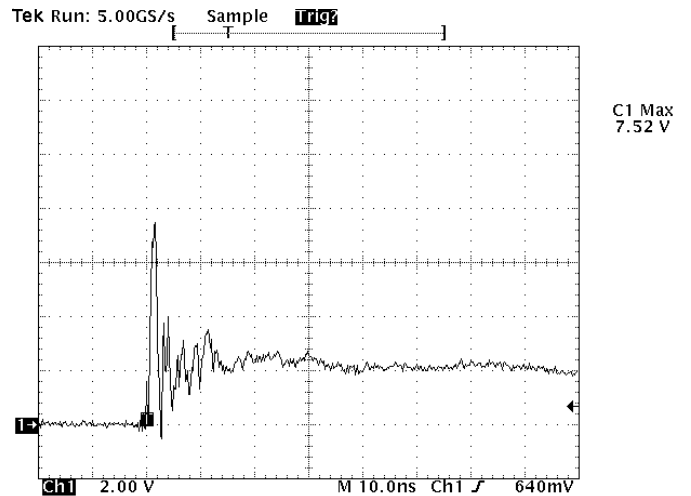

Note: Data is taken with a 10x attenuator

PROTECTION PRODUCTS

Applications Information

Device Connection Options

The μ Clamp3301P is designed to protect one data or I/O line operating at 3.3 volts. It will present a high impedance to the protected line up to 3.3 volts. It will “turn on” when the line voltage exceeds 3.5 volts. The device is unidirectional and may be used on lines where the signal polarity is above ground. The cathode band should be placed towards the line that is to be protected. These devices should not be connected to DC supply rails as they can latch up as described below.

Due to the “snap-back” characteristics of the low voltage TVS, it is not recommended that the I/O line be directly connected to a DC source greater than snap-back voltage (V_{SB}) as the device can latch on as described below.

EPD TVS Characteristics

The μ Clamp3301P is constructed using Semtech’s proprietary EPD technology. The structure of the EPD TVS is vastly different from the traditional pn-junction devices. At voltages below 5V, high leakage current and junction capacitance render conventional avalanche technology impractical for most applications. However, by utilizing the EPD technology, the μ Clamp3301P can effectively operate at 3.3V while maintaining excellent electrical characteristics.

The EPD TVS employs a complex npn structure in contrast to the pn structure normally found in traditional silicon-avalanche TVS diodes. Since the EPD TVS devices use a 4-layer structure, they exhibit a slightly different IV characteristic curve when compared to conventional devices. During normal operation, the device represents a high-impedance to the circuit up to the device working voltage (V_{RWM}). During an ESD event, the device will begin to conduct and will enter a low impedance state when the punch through voltage (V_{PT}) is exceeded. Unlike a conventional device, the low voltage TVS will exhibit a slight negative resistance characteristic as it conducts current. This characteristic aids in lowering the clamping voltage of the device, but must be considered in applications where DC voltages are present.

When the TVS is conducting current, it will exhibit a slight “snap-back” or negative resistance characteris-

Device Schematic & Pin Configuration

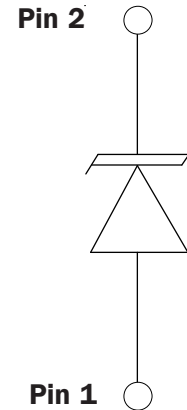

EPD TVS IV Characteristic Curve

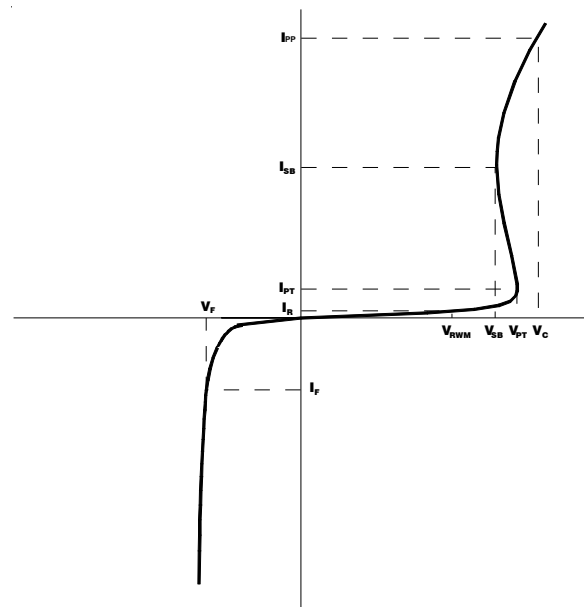

tics due to its structures. This point is defined on the curve by the snap-back voltage (V_{SB}) and snap-back current (I_{SB}). To return to a non-conducting state, the current through the device must fall below the I_{SB} (approximately $<50\text{mA}$) and the voltage must fall below the V_{SB} (normally 2.8 volts for a 3.3V device). If a 3.3V TVS is connected to 3.3V DC source, it will never fall below the snap-back voltage of 2.8V and will therefore stay in a conducting state.

PROTECTION PRODUCTS

Applications Information - Spice Model

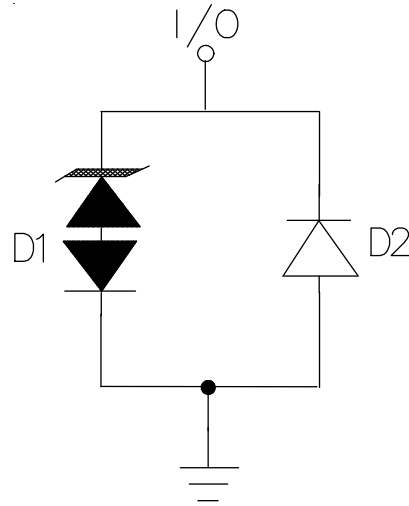
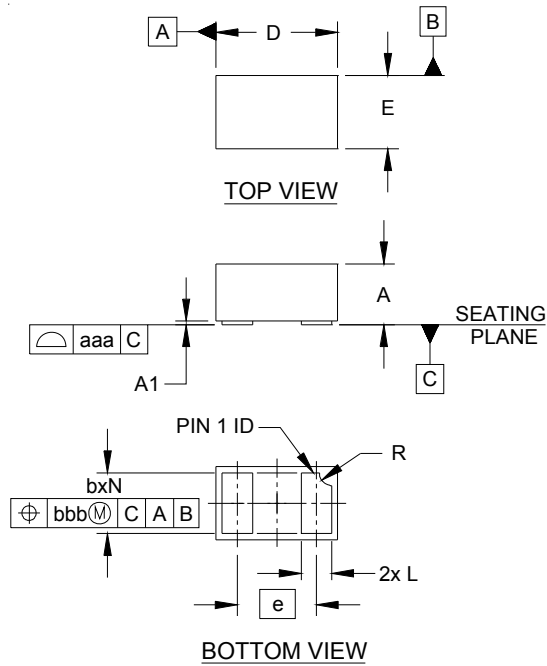

Figure 1 - uClamp3301P Spice Model

Table 1 - μ Clamp3301P Spice Parameters			
Parameter	Unit	D1 (TVS)	D2 (LCRD)
IS	Amp	1.00E-20	1.00E-20
BV	Volt	3.3	8
VJ	Volt	14	0.69
RS	Ohm	0.482	0.898
IBV	Amp	1.0E-3	1.0E-3
CJO	Farad	14E-12	7E-12
TT	sec	2.541E-9	2.541E-9
M	--	0.155	0.155
N	--	1.1	1.1
EG	eV	1.11	1.11

PROTECTION PRODUCTS

Outline Drawing - SLP1006P2



DIM	INCHES			MILLIMETERS		
	MIN	NOM	MAX	MIN	NOM	MAX
A	.016	.020	.022	0.40	0.50	0.55
A1	.000	.001	.002	0.00	0.03	0.05
b	.018	.020	.022	0.45	0.50	0.55
D	.035	.039	.043	0.90	1.00	1.10
E	.020	.024	.028	0.50	0.60	0.70
e	.026 BSC			0.65 BSC		
L	.008	.010	.012	0.20	0.25	0.30
R	.002	.004	.006	0.05	0.10	0.15
N	2			2		
aaa	.003			0.08		
bbb	.004			0.10		

NOTES:

1. CONTROLLING DIMENSIONS ARE IN MILLIMETERS (ANGLES IN DEGREES).

Land Pattern - SLP1006P2

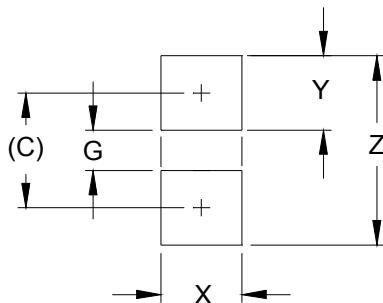

DIM	DIMENSIONS	
	INCHES	MILLIMETERS
C	(.033)	(0.85)
G	.012	0.30
X	.024	0.60
Y	.022	0.55
Z	.055	1.40

NOTES:

1. CONTROLLING DIMENSIONS ARE IN MILLIMETERS (ANGLES IN DEGREES).
2. THIS LAND PATTERN IS FOR REFERENCE PURPOSES ONLY. CONSULT YOUR MANUFACTURING GROUP TO ENSURE YOUR COMPANY'S MANUFACTURING GUIDELINES ARE MET.

PROTECTION PRODUCTS

Marking Code

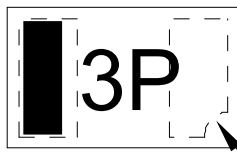

PIN 1 ID

Ordering Information

Part Number	Working Voltage	Qty per Reel	Reel Size
uClamp3301P.TCT	3.3V	3,000	7 Inch

Notes:

1) MicroClamp, uClamp and μ Clamp are trademarks of Semtech Corporation

Note: Cathode band at Pin 2

Tape and Reel Specification

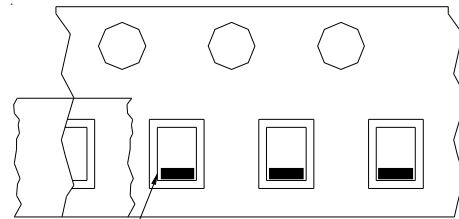
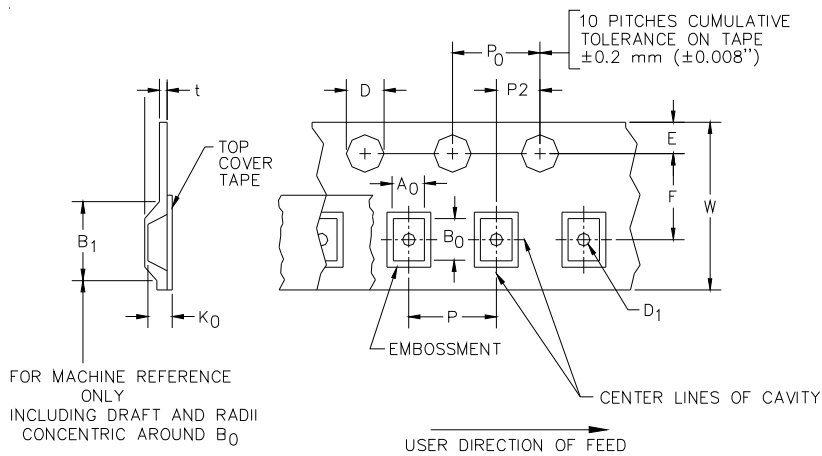

Cathode Band Location

→ User Direction of feed

Device Orientation in Tape

A0	B0	K0
0.69 +/-0.10 mm	1.19 +/-0.10 mm	0.66 +/-0.10 mm

Tape Width	B, (Max)	D	D1	E	F	P	P0	P2	T	W
8 mm	4.2 mm (.165)	1.5 + 0.1 mm - 0.0 mm (0.59 +.005 -.000)	0.4 mm ±0.25 (.031)	1.750±.10 mm (.069±.004)	3.5±0.05 mm (.138±.002)	4.0±0.10 mm (.157±.004)	4.0±0.1 mm (.157±.004)	2.0±0.05 mm (.079±.002)	0.254±0.02 mm (.016)	8.0 mm + 0.3 mm - 0.1 mm (.312±.012)

Contact Information

Semtech Corporation
 Protection Products Division
 200 Flynn Road, Camarillo, CA 93012
 Phone: (805)498-2111 FAX (805)498-3804