

**General Description**

The UD6004 is the highest performance trench N-ch MOSFETs with extreme high cell density, which provide excellent RDSON and gate charge for most of the synchronous buck converter applications.

The UD6004 meet the RoHS and Green Product requirement, 100% EAS guaranteed with full function reliability approved.

**Features**

- Advanced high cell density Trench technology
- Super Low Gate Charge
- Excellent CdV/dt effect decline
- 100% EAS Guaranteed
- Green Device Available

**Absolute Maximum Ratings**

Symbol	Parameter	Rating	Units
$V_{DS}$	Drain-Source Voltage	60	V
$V_{GS}$	Gate-Source Voltage	$\pm 20$	V
$I_D@T_C=25^\circ C$	Continuous Drain Current, $V_{GS} @ 10V^1$	25	A
$I_D@T_C=100^\circ C$	Continuous Drain Current, $V_{GS} @ 10V^1$	18	A
$I_{DM}$	Pulsed Drain Current <sup>2</sup>	50	A
EAS	Single Pulse Avalanche Energy <sup>3</sup>	34.5	mJ
$I_{AS}$	Avalanche Current	22.6	A
$P_D@T_C=25^\circ C$	Total Power Dissipation <sup>4</sup>	34.7	W
$T_{STG}$	Storage Temperature Range	-55 to 150	$^\circ C$
$T_J$	Operating Junction Temperature Range	-55 to 150	$^\circ C$

**Thermal Data**

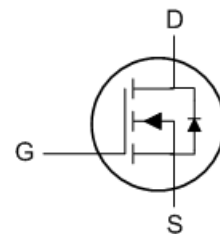
Symbol	Parameter	Typ.	Max.	Unit
$R_{\theta JA}$	Thermal Resistance Junction-Ambient <sup>1</sup>	---	62	$^\circ C/W$
$R_{\theta JC}$	Thermal Resistance Junction-Case <sup>1</sup>	---	3.6	$^\circ C/W$

**Product Summary**

$BV_{DSS}$	$R_{DS(ON)}$	ID
60V	30m $\Omega$	25A

**Applications**

- High Frequency Point-of-Load Synchronous Buck Converter.
- Networking DC-DC Power System
- Load Switch

**TO252 Pin Configuration**


**Electrical Characteristics ( $T_J=25\text{ }^\circ\text{C}$ , unless otherwise noted)**

Symbol	Parameter	Conditions	Min.	Typ.	Max.	Unit
$BV_{DSS}$	Drain-Source Breakdown Voltage	$V_{GS}=0V, I_D=250\mu A$	60	---	---	V
$\Delta BV_{DSS}/\Delta T_J$	$BV_{DSS}$ Temperature Coefficient	Reference to $25\text{ }^\circ\text{C}$ , $I_D=1mA$	---	0.063	---	V/ $^\circ\text{C}$
$R_{DS(ON)}$	Static Drain-Source On-Resistance <sup>2</sup>	$V_{GS}=10V, I_D=15A$	---	25	30	m $\Omega$
		$V_{GS}=4.5V, I_D=10A$	---	30	38	
$V_{GS(th)}$	Gate Threshold Voltage	$V_{GS}=V_{DS}, I_D=250\mu A$	1.2		2.5	V
$\Delta V_{GS(th)}$	$V_{GS(th)}$ Temperature Coefficient		---	-5.24	---	mV/ $^\circ\text{C}$
$I_{DSS}$	Drain-Source Leakage Current	$V_{DS}=48V, V_{GS}=0V, T_J=25\text{ }^\circ\text{C}$	---	---	1	$\mu A$
		$V_{DS}=48V, V_{GS}=0V, T_J=55\text{ }^\circ\text{C}$	---	---	5	
$I_{GSS}$	Gate-Source Leakage Current	$V_{GS}=\pm 20V, V_{DS}=0V$	---	---	$\pm 100$	nA
gfs	Forward Transconductance	$V_{DS}=5V, I_D=15A$	---	17	---	S
$R_g$	Gate Resistance	$V_{DS}=0V, V_{GS}=0V, f=1MHz$	---	3.2		$\Omega$
$Q_g$	Total Gate Charge (4.5V)	$V_{DS}=48V, V_{GS}=4.5V, I_D=10A$	---	12.56	---	nC
$Q_{gs}$	Gate-Source Charge		---	3.24	---	
$Q_{gd}$	Gate-Drain Charge		---	6.31	---	
$T_{d(on)}$	Turn-On Delay Time	$V_{DD}=30V, V_{GS}=10V, R_G=3.3\Omega, I_D=10A$	---	8	---	ns
$T_r$	Rise Time		---	14.2	---	
$T_{d(off)}$	Turn-Off Delay Time		---	24.4	---	
$T_f$	Fall Time		---	4.6	---	
$C_{iss}$	Input Capacitance	$V_{DS}=25V, V_{GS}=0V, f=1MHz$	---	1345	---	pF
$C_{oss}$	Output Capacitance		---	72.5	---	
$C_{rss}$	Reverse Transfer Capacitance		---	54.4	---	

**Guaranteed Avalanche Characteristics**

Symbol	Parameter	Conditions	Min.	Typ.	Max.	Unit
EAS	Single Pulse Avalanche Energy <sup>5</sup>	$V_{DD}=25V, L=0.1mH, I_{AS}=15A$	15.2	---	---	mJ

**Diode Characteristics**

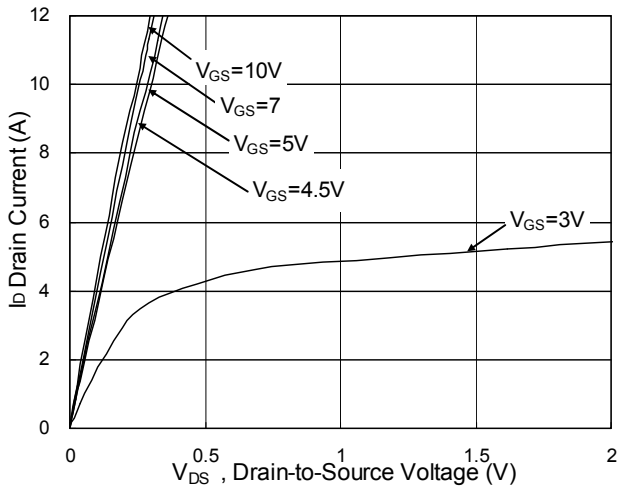
Symbol	Parameter	Conditions	Min.	Typ.	Max.	Unit
$I_S$	Continuous Source Current <sup>1,6</sup>	$V_G=V_D=0V$ , Force Current	---	---	25	A
$I_{SM}$	Pulsed Source Current <sup>2,6</sup>		---	---	50	A
$V_{SD}$	Diode Forward Voltage <sup>2</sup>	$V_{GS}=0V, I_S=1A, T_J=25\text{ }^\circ\text{C}$	---	---	1.2	V

Note :

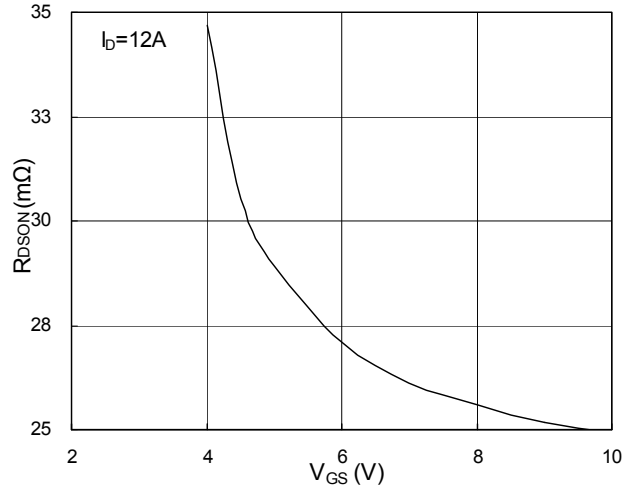
- 1.The data tested by surface mounted on a 1 inch<sup>2</sup> FR-4 board with 20Z copper.
- 2.The data tested by pulsed , pulse width  $\leq 300\mu s$ , duty cycle  $\leq 2\%$
- 3.The EAS data shows Max. rating . The test condition is  $V_{DD}=25V, V_{GS}=10V, L=0.1mH, I_{AS}=15A$
- 4.The power dissipation is limited by  $150\text{ }^\circ\text{C}$  junction temperature
- 5.The Min. value is 100% EAS tested guarantee.
- 6.The data is theoretically the same as  $I_D$  and  $I_{DM}$ , in real applications , should be limited by total power dissipation.

**N-Ch 60V Fast Switching MOSFETs**

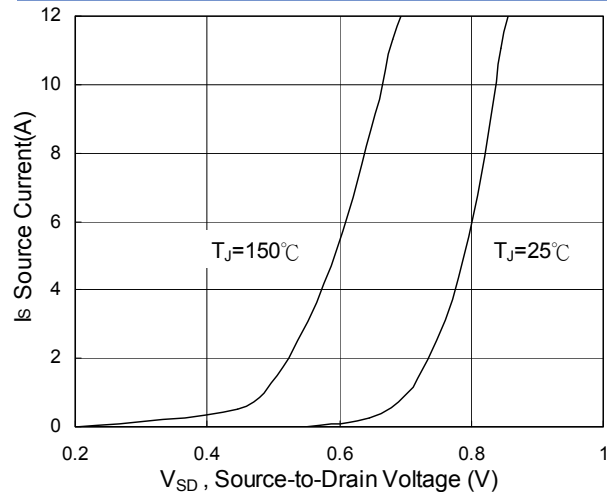
**Typical Characteristics**



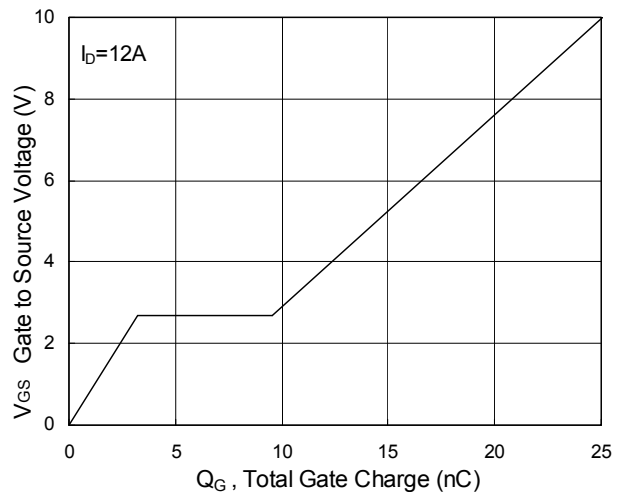
**Fig.1 Typical Output Characteristics**



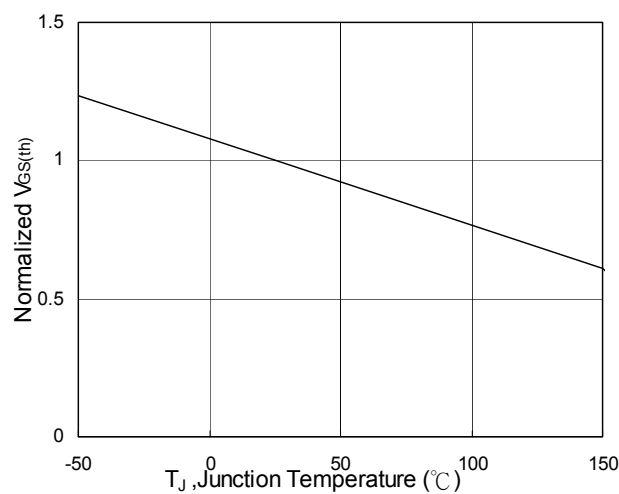
**Fig.2 On-Resistance v.s Gate-Source**



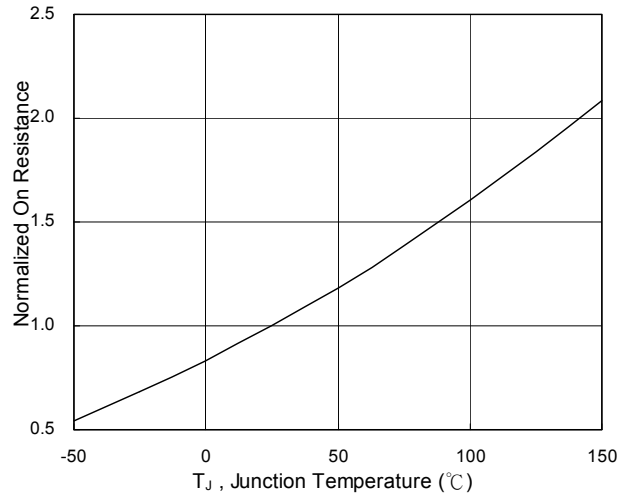
**Fig.3 Forward Characteristics of Reverse**



**Fig.4 Gate-Charge Characteristics**

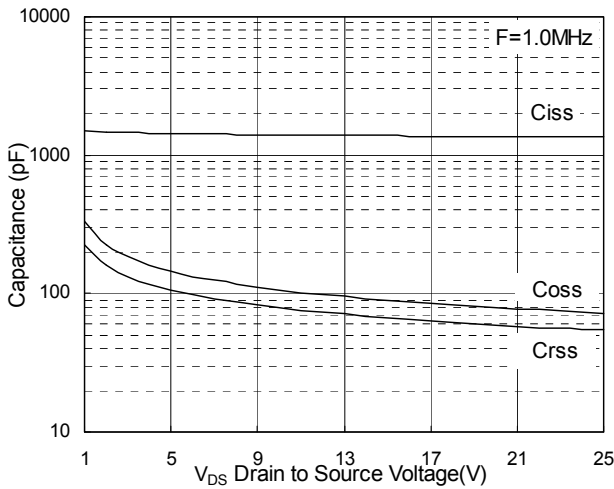


**Fig.5 Normalized  $V_{GS(th)}$  v.s  $T_J$**

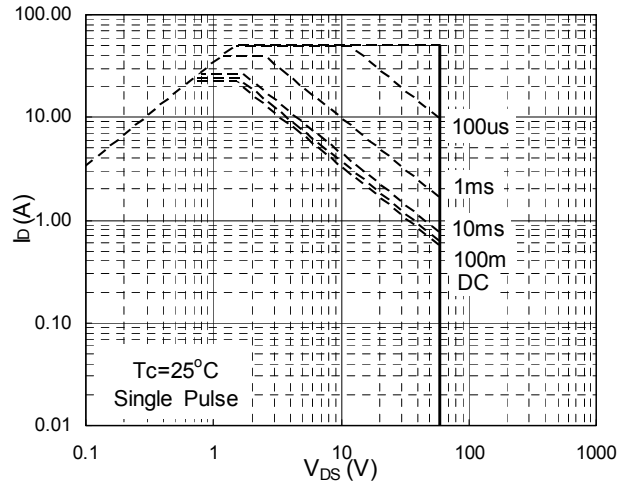


**Fig.6 Normalized  $R_{DS(on)}$  v.s  $T_J$**

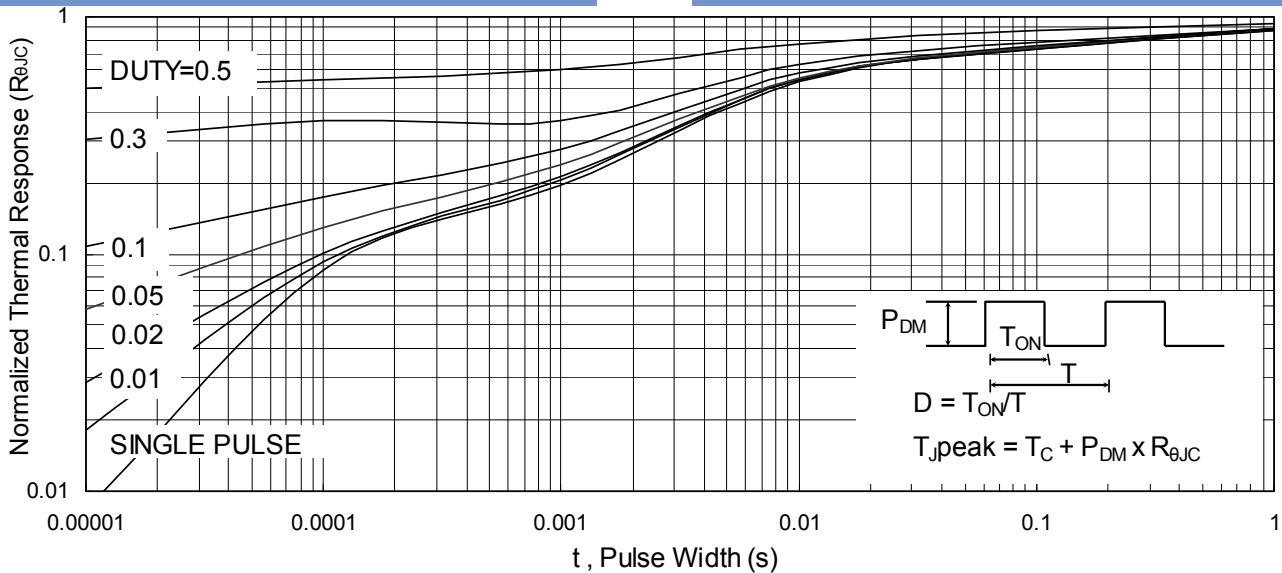
**N-Ch 60V Fast Switching MOSFETs**



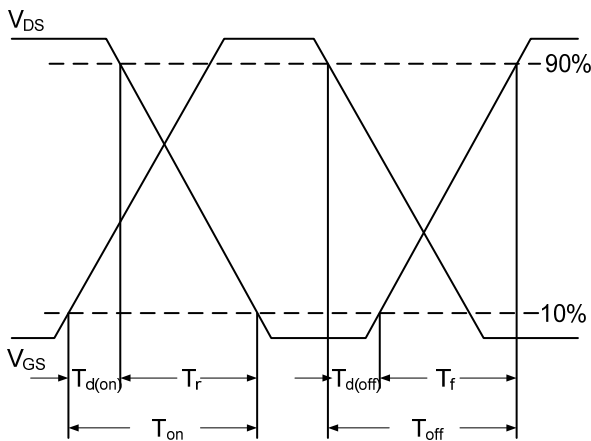
**Fig.7 Capacitance**



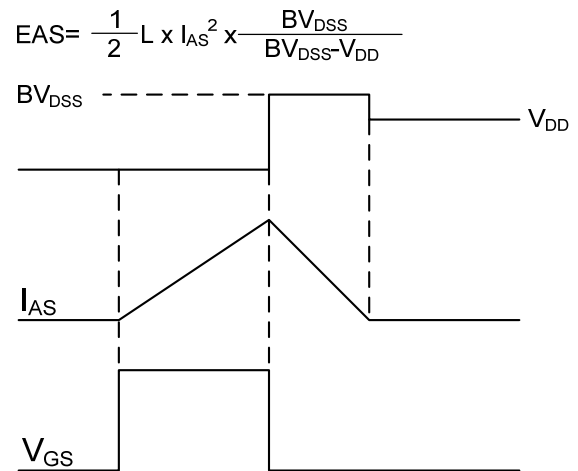
**Fig.8 Safe Operating Area**



**Fig.9 Normalized Maximum Transient Thermal Impedance**



**Fig.10 Switching Time Waveform**



**Fig.11 Unclamped Inductive Waveform**