



UDN302

Power MOSFET

**P-CHANNEL 2.5V SPECIFIED
POWERTRENCH MOSFET**

■ DESCRIPTION

The **UDN302** uses advanced trench technology to provide excellent $R_{DS(ON)}$, low gate charge and operation with low gate voltages. This device is suitable for use as a load switch or in PWM applications.

■ FEATURES

- * $R_{DS(ON)}=55m\Omega @ V_{GS}=-4.5V$
- * $R_{DS(ON)}=80m\Omega @ V_{GS}=-2.5V$
- * Low capacitance
- * Low gate charge
- * Fast switching capability
- * Avalanche energy specified

■ SYMBOL

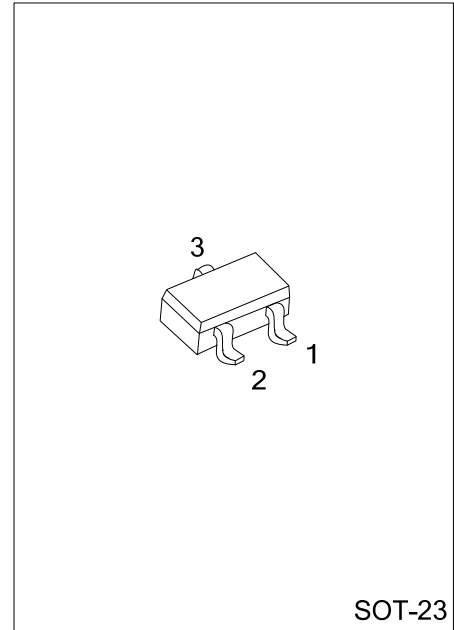
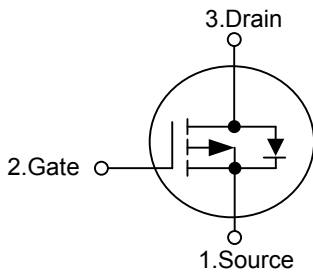

SOT-23

■ ORDERING INFORMATION

Ordering Number		Package	Pin Assignment			Packing
Lead Free	Halogen Free		1	2	3	
UDN302L-AE3-R	UDN302G-AE3-R	SOT-23	S	G	D	Tape Reel

<p>UDN302L-AE3-R</p> <p>(1)Packing Type</p> <p>(2)Package Type</p> <p>(3)Lead Plating</p>	<p>(1) R: Tape Reel</p> <p>(2) AE3: SOT-23</p> <p>(3) G: Halogen Free, L: Lead Free</p>
---	---

■ MARKING

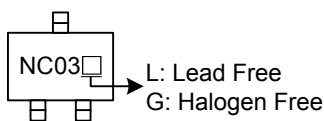

■ ABSOLUTE MAXIMUM RATINGS ($T_a=25^\circ\text{C}$, unless otherwise specified)

PARAMETER	SYMBOL	RATINGS	UNIT
Drain-Source Voltage	V_{DSS}	-20	V
Gate-Source Voltage	V_{GSS}	± 12	V
Continuous Drain Current	I_D	-2.4	A
Pulsed Drain Current	I_{DM}	-10	A
Maximum Power Dissipation	P_D	0.5	W
Junction Temperature	T_J	+150	$^\circ\text{C}$
Storage Temperature	T_{STG}	-55 ~ +150	$^\circ\text{C}$

Note: Absolute maximum ratings are those values beyond which the device could be permanently damaged.

Absolute maximum ratings are stress ratings only and functional device operation is not implied.

■ THERMAL DATA

PARAMETER	SYMBOL	MIN	TYP	MAX	UNIT
Junction-to-Ambient	θ_{JA}			250	$^\circ\text{C}/\text{W}$
Junction-to-Case	θ_{JC}			75	$^\circ\text{C}/\text{W}$

■ ELECTRICAL CHARACTERISTICS ($T_a=25^\circ\text{C}$, unless otherwise specified)

PARAMETER	SYMBOL	TEST CONDITIONS	MIN	TYP	MAX	UNIT
OFF CHARACTERISTICS						
Drain-Source Breakdown Voltage	BV_{DSS}	$V_{GS}=0\text{V}, I_D=-250\mu\text{A}$	-20			V
Breakdown Voltage Temperature Coefficient	$\Delta BV_{DSS}/\Delta T_J$	$I_D=-250\mu\text{A}$, Referenced to 25°C		-12		$\text{mV}/^\circ\text{C}$
Drain-Source Leakage Current	I_{DSS}	$V_{DS}=-16\text{V}, V_{GS}=0\text{V}$			-1	μA
Gate-Source Leakage Current	I_{GSS}	$V_{GS}=\pm 12\text{V}, V_{DS}=0\text{V}$			± 100	nA
ON CHARACTERISTICS (Note)						
Gate Threshold Voltage	$V_{GS(TH)}$	$V_{DS}=V_{GS}, I_D=-250\mu\text{A}$	-0.6	-1.0	-1.5	V
Gate Threshold Voltage Temperature Coefficient	$\Delta V_{GS(TH)}/\Delta T_J$	$I_D=-250\mu\text{A}$, Referenced to 25°C		3		$\text{mV}/^\circ\text{C}$
Static Drain-Source On-Resistance	$R_{DS(ON)}$	$V_{GS}=-4.5\text{V}, I_D=-2.4\text{A}$ $V_{GS}=-2.5\text{V}, I_D=-2\text{A}$		44 64	55 80	$\text{m}\Omega$
On-State Drain Current	$I_{D(ON)}$	$V_{GS}=-4.5\text{V}, V_{DS}=-5\text{V}$	-10			A
Forward Transconductance	g_{FS}	$V_{DS}=-5\text{V}, I_D=-2.4\text{A}$		10		S
DYNAMIC PARAMETERS						
Input Capacitance	C_{ISS}	$V_{DS}=-10\text{V}, V_{GS}=0\text{V}, f=1.0\text{MHz}$		882		pF
Output Capacitance	C_{OSS}			211		pF
Reverse Transfer Capacitance	C_{RSS}			112		pF
SWITCHING PARAMETERS (Note)						
Total Gate Charge	Q_G	$V_{DS}=-10\text{V}, I_D=-2.4\text{A}$, $V_{GS}=-4.5\text{V}$		9	14	nC
Gate Source Charge	Q_{GS}			2		nC
Gate Drain Charge	Q_{GD}			3		nC
Turn-ON Delay Time	$t_{D(ON)}$	$V_{DD}=-10\text{V}, I_D=-1\text{A}, V_{GS}=-4.5\text{V}$ $R_G=6\Omega$		13	23	ns
Turn-ON Rise Time	t_R			11	20	ns
Turn-OFF Delay Time	$t_{D(OFF)}$			25	40	ns
Turn-OFF Fall-Time	t_F			15	27	ns
SOURCE- DRAIN DIODE RATINGS AND CHARACTERISTICS						
Diode Forward Voltage	V_{SD}	$V_{GS}=0\text{V}, I_S=-0.42\text{A}$ (Note)		-0.7	-1.2	V
Maximum Body-Diode Continuous Current	I_S				-0.42	A

Note: Pulse Test: Pulse width $\leq 300\mu\text{s}$, Duty cycle $\leq 2\%$

TYPICAL CHARACTERISTICS

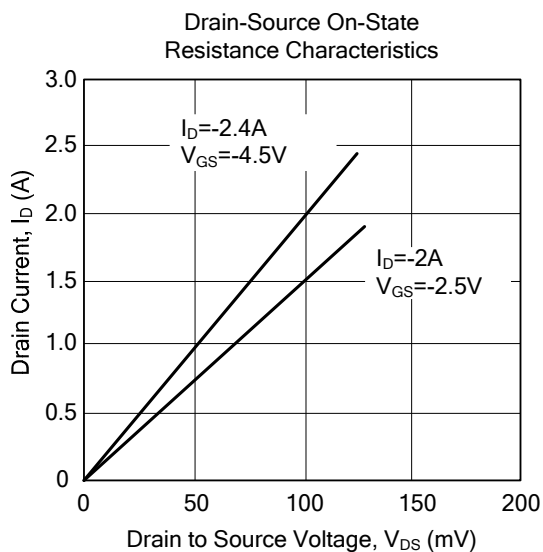
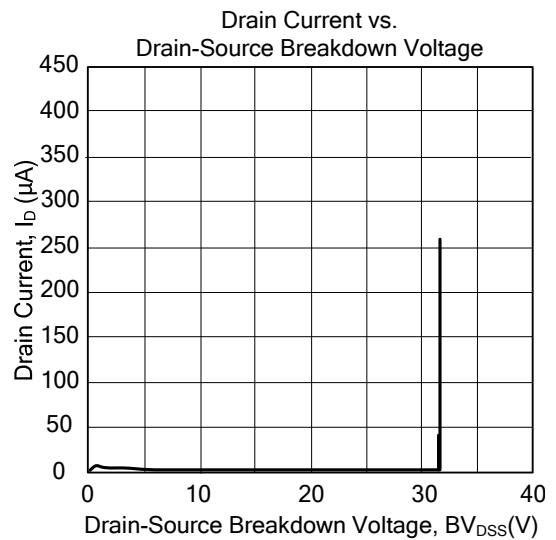
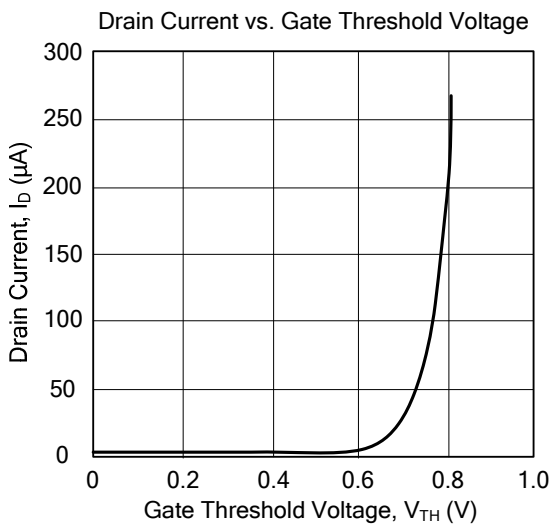
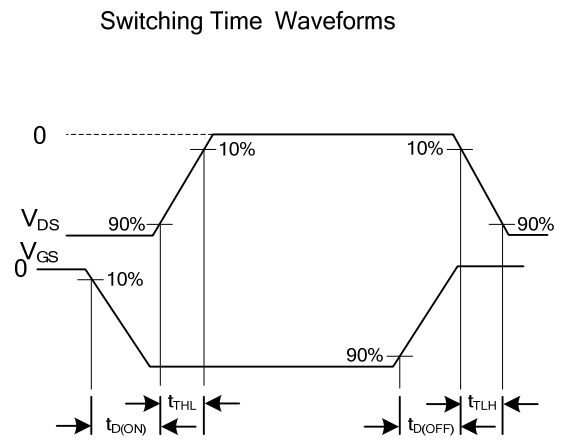
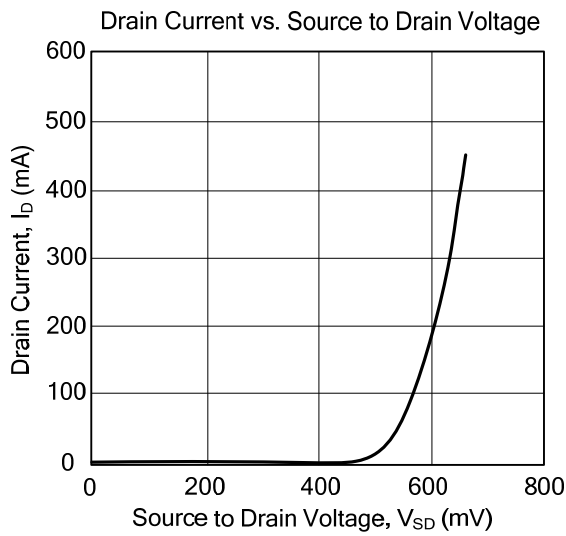

UTC assumes no responsibility for equipment failures that result from using products at values that exceed, even momentarily, rated values (such as maximum ratings, operating condition ranges, or other parameters) listed in products specifications of any and all UTC products described or contained herein. UTC products are not designed for use in life support appliances, devices or systems where malfunction of these products can be reasonably expected to result in personal injury. Reproduction in whole or in part is prohibited without the prior written consent of the copyright owner. The information presented in this document does not form part of any quotation or contract, is believed to be accurate and reliable and may be changed without notice.