

**ULTRA-FAST PLASTIC RECTIFIER**  
**VOLTAGE RANGE 50 TO 1000 Volts**  
**CURRENT 3.0 Ampere**

**FEATURES**

- \* Ultra-fast recovery time for high efficiency
- \* Glass Passivated Chip junction
- \* Excellent high temperature switching
- \* Low reverse leakage current
- \* Low forward voltage drop
- \* High current capability

**MECHANICAL DATA**

- \* Case : JEDEC DO-15ic
- \* Epoxy: UL94V-O rate flame retardant
- \* Terminals : Solderable Per MIL-STD-202 Method 208
- \* Polarity : Color band denotes cathode end
- \* Mounting position: Any
- \* Weight : 0.015 ounces,0.4 grams

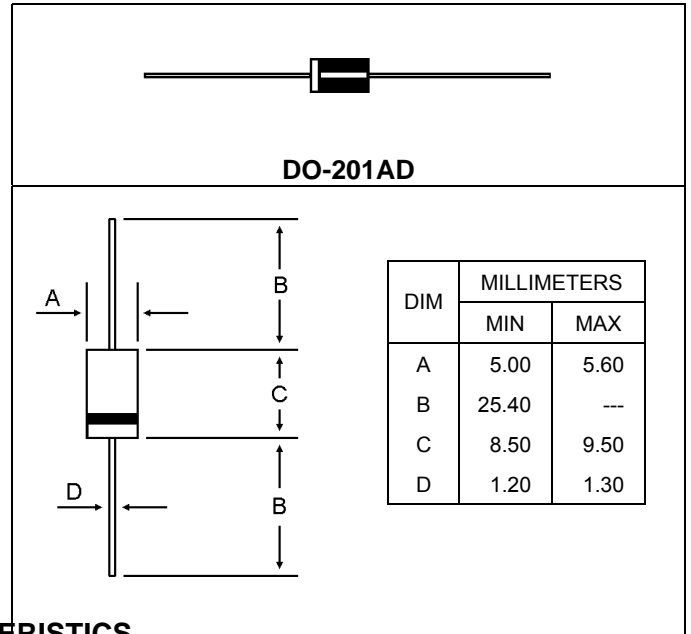

**MAXIMUM RATINGS AND ELECTRICAL CHARACTERISTICS**

- \* Rating at 25 °C ambient temperature unless otherwise specified
- \* Single phase, half wave, 60Hz, resistive or inductive load.
- \* For capacitive load derate current by 20 %

Characteristic	Symbol	UF	UF	UF	UF	UF	UF	UF	UF	UF	Unit
		5400	5401	5402	5403	5404	5405	5406	5407	5408	
Peak Repetitive Reverse Voltage Working Peak Reverse Voltage DC Blocking Voltage	$V_{RRM}$ $V_{RWM}$ $V_R$	50	100	200	300	400	500	600	800	1000	V
RMS Reverse Voltage	$V_{R(RMS)}$	35	70	140	210	280	350	420	560	700	V
Average Rectifier Forward Current Per Leg $T_C=55$	$I_{F(AV)}$	3.0									A
Non-Repetitive Peak Surge Current (Surge applied at rate load conditions halfwave, single phase, 60Hz)	$I_{FSM}$	150									A
Maximum Instantaneous Forward Voltage ( $I_F=3.0$ Amp $T_C=25$ )	$V_F$	1.0			1.7					V	
Maximum Instantaneous Reverse Current ( Rated DC Voltage, $T_C=25$ ) ( Rated DC Voltage, $T_C=100$ )	$I_R$	10 75			10 200					$\mu$ A	
Reverse Recovery Time ( $I_F=0.5$ A, $I_R=1.0$ , $I_{rr}=0.25$ A )	$T_{rr}$	50			75					ns	
Typical Junction Capacitance (Reverse Voltage of 4 volts & f=1 MHz)	$C_j$	45			36					pF	
Typical Thermal Resistance (1)	$R_{\theta Ja}$ $R_{\theta Jc}$	20 8.5									/W
Operating and Storage Junction Temperature Range	$T_J, T_{stg}$	-65 to +150									

Notes:

- (1) Thermal resistance from junction to lead and from junction to ambient with 0.375"(9.5mm) lead length, both leads attached to heatsink

# UF5400 Thru UF5408

FIG-1 TYPICAL FORWARD CHARACTERISTICS

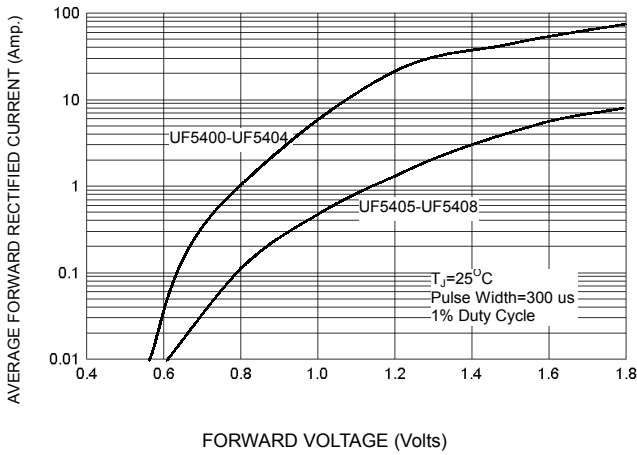

FIG-3 FORWARD CURRENT DERATING CURVE

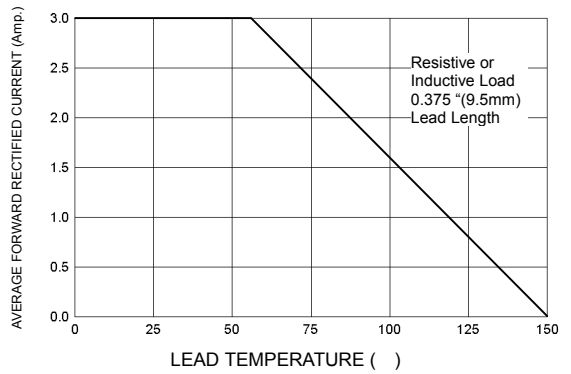

FIG-2 TYPICAL REVERSE CHARACTERISTICS

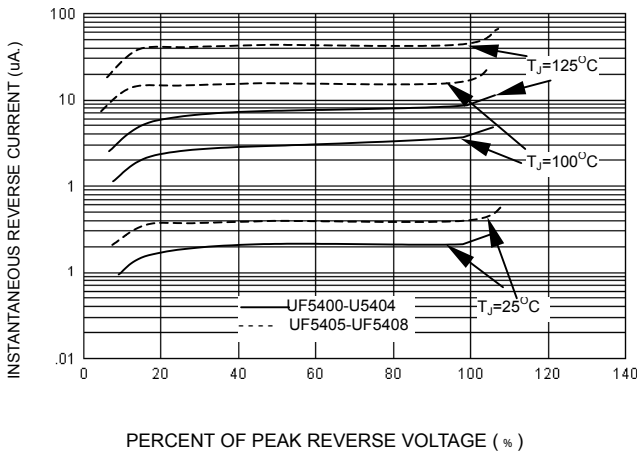

FIG-4 TYPICAL JUNCTION CAPACITANCE

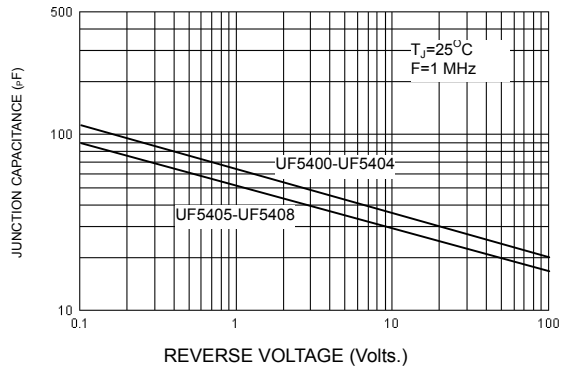
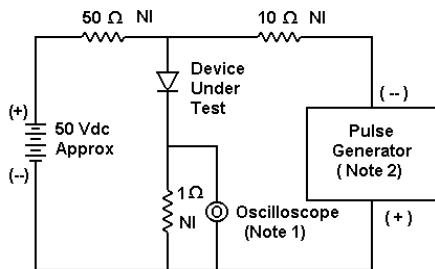
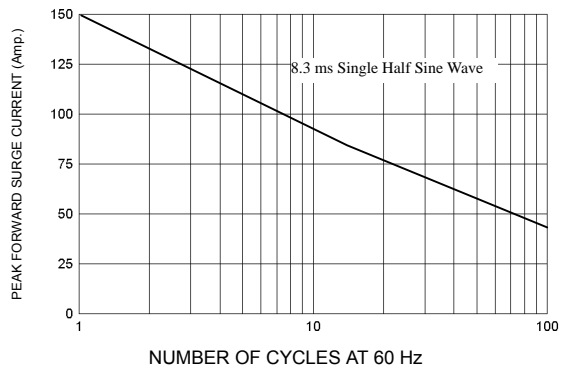
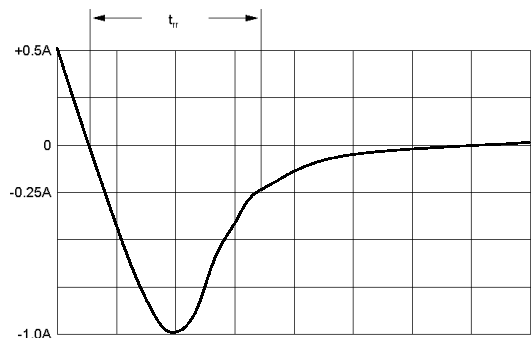

FIG-5 PEAK FORWARD SURGE CURRENT



- Notes:  
 1. Rise Time = 7 ns max. Input Impedance = 1 M  $\Omega$ , 22 pF  
 2. Rise Time = 10 ns max. Input Impedance = 50  $\Omega$



Set time base for 10/20 ns/cm

FIG-6 Reverse Recovery Time Characteristic and Test Circuit Diagram

22C-426

Unit:mm

