



UF5GI / UF504IG

ULTRAFAST RECOVERY RECTIFIERS

Voltage

400 V

Current

5 A

Features

- Silicon epitaxial high-speed diodes
- Soft recovery characteristics
- Low forward voltage, high current capability
- Hermetically sealed.
- Low leakage
- High surge capacity
- Lead free in compliance with EU RoHS 2011/65/EU directive
- Green molding compound as per IEC61249 Std. . (Halogen Free)(SMC)

Mechanical Data

- Case: Molded plastic, SMC, DO-201AD
- Terminals: Solder plated, solderable per MIL-STD-750, Method 2026
- Polarity: Color Band denotes cathode end
- SMC Approx. Weight: 0.0082 ounces, 0.2325 grams
- DO-201AD Approx. Weight: 0.04 ounces, 1.142 grams
- Marking: Part number

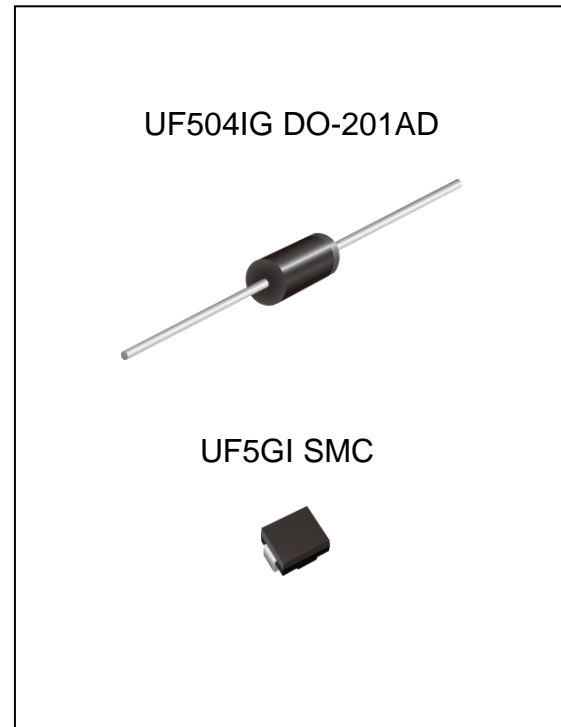
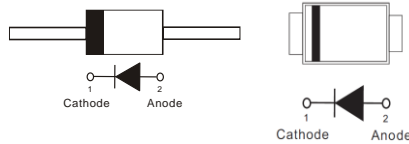

Maximum Ratings ($T_A=25^{\circ}\text{C}$ unless otherwise noted)

PARAMETER	SYMBOL	LIMIT	UNIT
Maximum repetitive peak reverse voltage	V_{RRM}	400	V
Maximum rms voltage	V_{RMS}	280	V
Maximum dc blocking voltage	V_R	400	V
Maximum average forward current	$I_{F(AV)}$	5	A
Peak forward surge current : 8.3ms single half sine-wave superimposed on rated load	I_{FSM}	80	A
Maximum forward voltage at 5A	V_F	1.25	V
Maximum dc reverse current at rated dc blocking voltage	I_R	1	μA
Maximum reverse recovery time	(Note 4) T_{RR}	50	ns
Typical thermal resistance	SMC(Note 3) $R_{\theta JA}$	125	$^{\circ}\text{C/W}$
	SMC(Note 1) $R_{\theta JC}$	14	
	DO-201AD(Note 2) $R_{\theta JL}$	24	
Operating and storage temperature range	T_J, T_{STG}	-55 to +150	$^{\circ}\text{C}$

Note : 1. Mounted on a FR4 PCB, single-sided copper, with 100cm² copper pad area

2. The testing condition of the thermal resistance (junction to lead) is based on 10 mm lead length between two 10cm x 10cm x 0.5mm copper pad

3. Mounted on a FR4 PCB, single-sided copper, mini pad.

4. Reverse Recovery Test Conditions : $I_F=0.5\text{A}$, $I_R=1\text{A}$, Recover to 0.25A



UF5GI / UF504IG

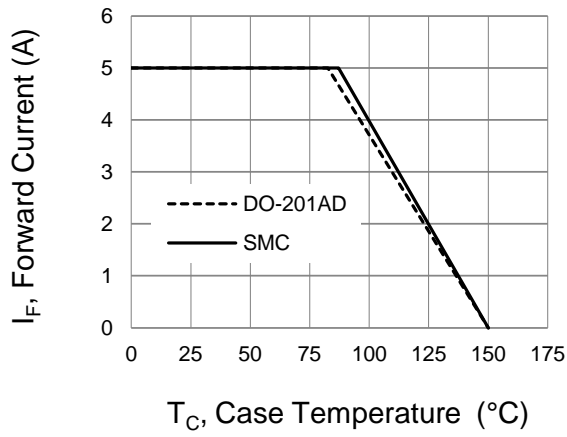

Fig.1 Forward Current Derating Curve

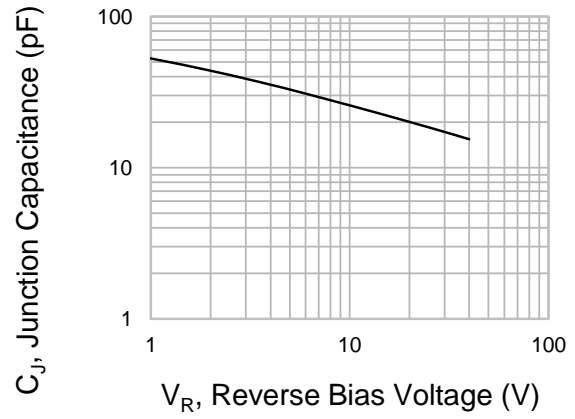

Fig.2 Typical Junction Capacitance

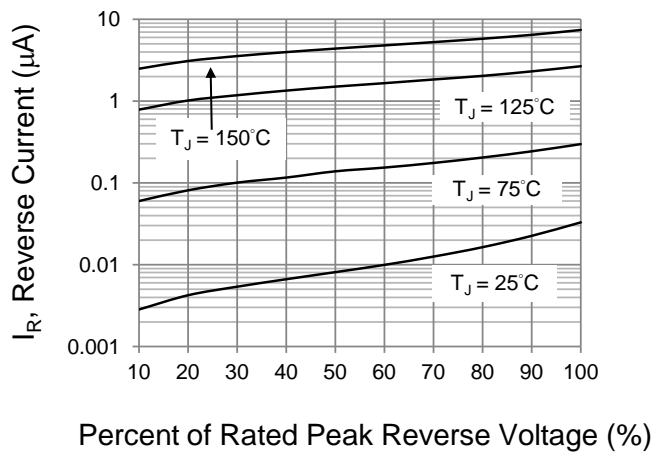

Fig.3 Typical Reverse Characteristics

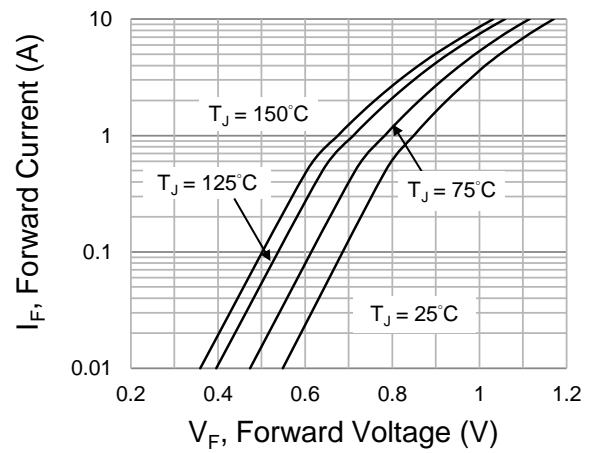
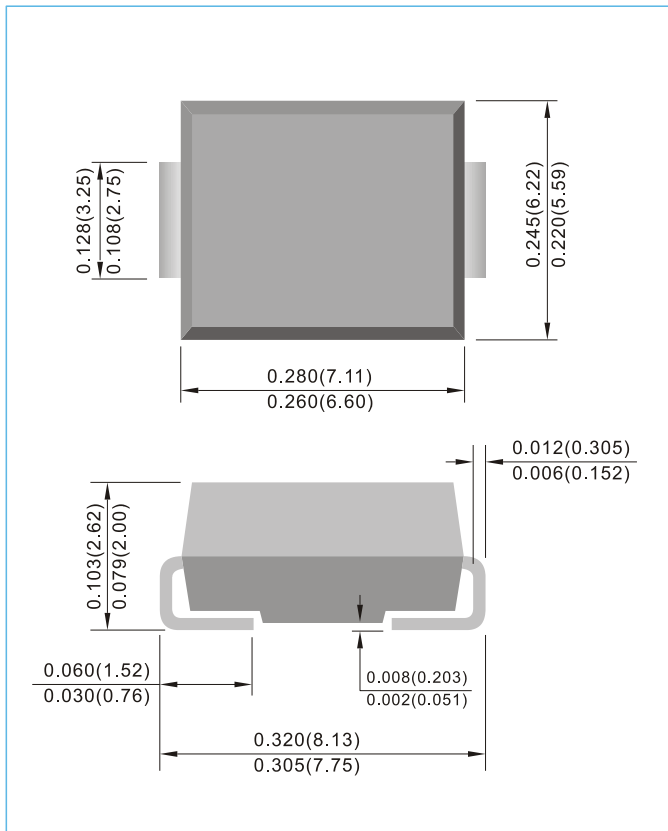

Fig.4 Typical Forward Characteristics



UF5GI / UF504IG

SMC / DO-214AB Unit : inch(mm)



DO-201AD Unit : inch(mm)

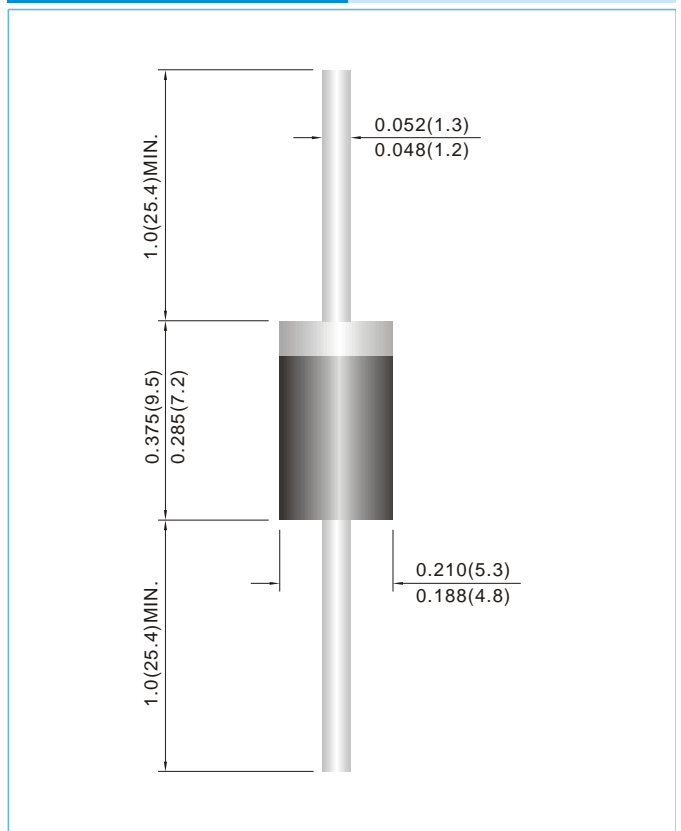



UF5GI / UF504IG

MOUNTING PAD LAYOUT

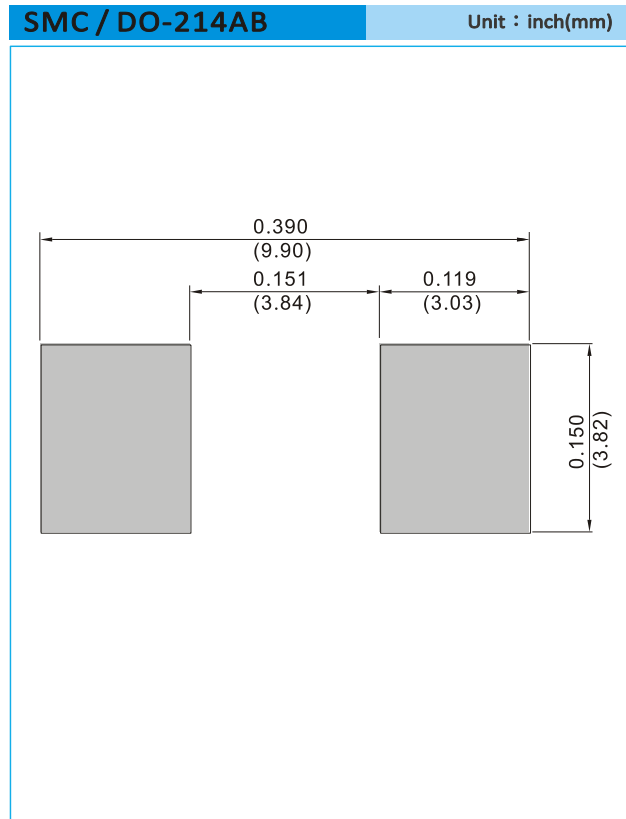

ORDER INFORMATION

- Packing information
 - T/R – 3K per 13" plastic Reel
 - T/R – 0.5K per 7" plastic Reel



UF5GI / UF504IG

Part No_packing code_Version

UF504IG_AY_00001
 UF504IG_AY_10001
 UF504IG_B0_00001
 UF504IG_B0_10001
 UF504IG_R2_00001
 UF504IG_R2_10001
 UF5GI_R1_00001
 UF5GI_R2_00001

For example :

RB500V-40_R2_00001

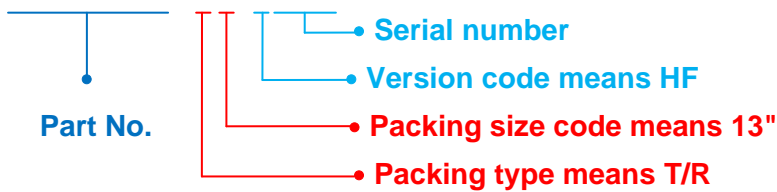

Packing Code XX				Version Code XXXXX		
Packing type	1 st Code	Packing size code	2 nd Code	HF or RoHS	1 st Code	2 nd ~5 th Code
Tape and Ammunition Box (T/B)	A	N/A	0	HF	0	serial number
Tape and Reel (T/R)	R	7"	1	RoHS	1	serial number
Bulk Packing (B/P)	B	13"	2			
Tube Packing (T/P)	T	26mm	X			
Tape and Reel (Right Oriented) (TRR)	S	52mm	Y			
Tape and Reel (Left Oriented) (TRL)	L	PANASERT T/B CATHODE UP (PBCU)	U			
FORMING	F	PANASERT T/B CATHODE DOWN (PBCD)	D			



UF5GI / UF504IG

Disclaimer

- Reproducing and modifying information of the document is prohibited without permission from Panjit International Inc..
- Panjit International Inc. reserves the rights to make changes of the content herein the document anytime without notification. Please refer to our website for the latest document.
- Panjit International Inc. disclaims any and all liability arising out of the application or use of any product including damages incidentally and consequentially occurred.
- Panjit International Inc. does not assume any and all implied warranties, including warranties of fitness for particular purpose, non-infringement and merchantability.
- Applications shown on the herein document are examples of standard use and operation. Customers are responsible in comprehending the suitable use in particular applications. Panjit International Inc. makes no representation or warranty that such applications will be suitable for the specified use without further testing or modification.
- The products shown herein are not designed and authorized for equipments requiring high level of reliability or relating to human life and for any applications concerning life-saving or life-sustaining, such as medical instruments, transportation equipment, aerospace machinery et cetera. Customers using or selling these products for use in such applications do so at their own risk and agree to fully indemnify Panjit International Inc. for any damages resulting from such improper use or sale.
- Since Panjit uses lot number as the tracking base, please provide the lot number for tracking when complaining.