

LINEAR OUTPUT HALL EFFECT SENSORS

Utilizing the Hall effect for sensing a magnetic field, UGN3501U and UGN3501UA integrated circuits provide a linear single-ended output that is a function of magnetic field intensity.

These devices can sense relatively small changes in a magnetic field — changes that are too small to operate a Hall effect switch. They can be capacitively coupled to an amplifier, to boost the output to a higher level.

The UGN3501U/UA include a Hall cell, linear amplifier, emitter-follower output, and a voltage regulator. Integrating the Hall cell and the amplifier into one monolithic device minimizes problems related to the handling of millivolt analog signals.

Both devices are rated for continuous operation over the temperature range of 0°C to +70°C and over a supply voltage range of 8V to 12 V.

FEATURES

- Excellent Sensitivity
- Flat Response to 25 kHz (typ.)
- Internal Voltage Regulation
- Excellent Temperature Stability

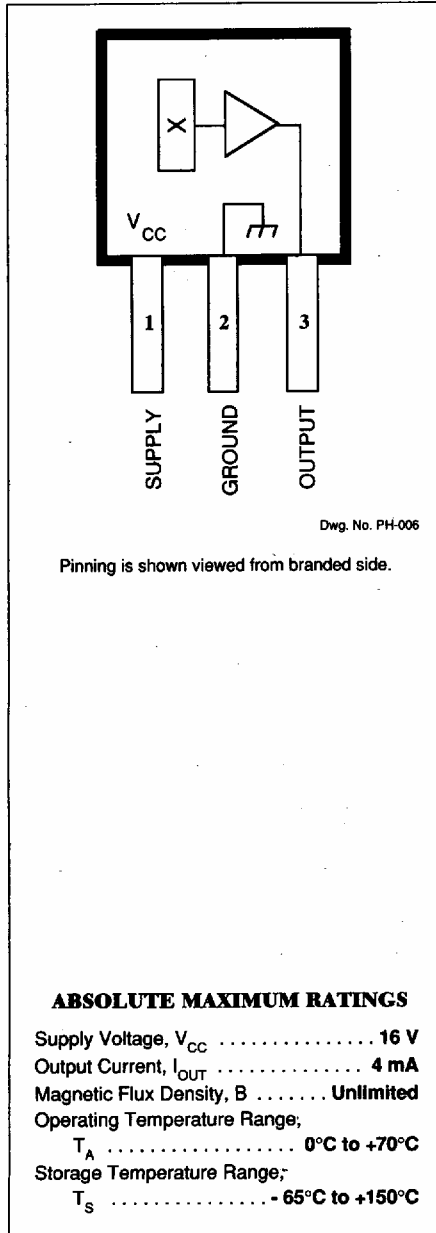

Always order by complete part number:

Part Number	Package
UGN3501U	3-Pin Mini-SIP
UGN3501UA	3-Pin Ultra-Mini-SIP

3501 LINEAR OUTPUT HALL EFFECT SENSORS

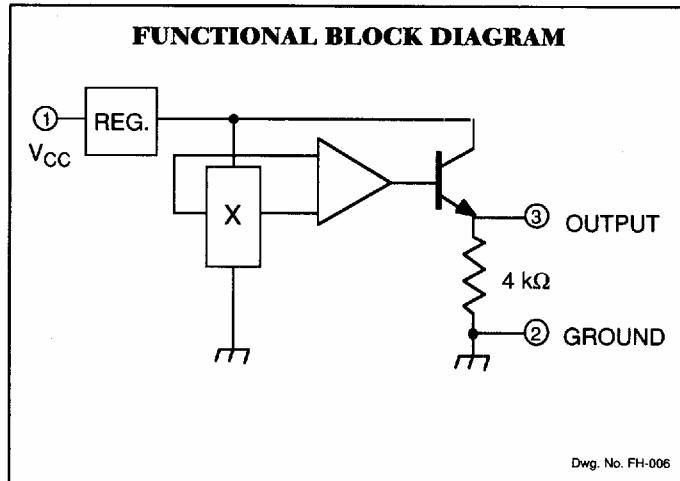

ELECTRICAL CHARACTERISTICS at $T_A = +25^\circ\text{C}$, $V_{CC} = 12\text{ V}$

Characteristic	Symbol	Test Conditions	Limits			
			Min.	Typ.	Max.	Units
Operating Voltage	V_{CC}		8.0	—	12	V
Supply Current	I_{CC}	$V_{CC} = 12\text{ V}$	—	10	20	mA
Quiescent Output Voltage	V_{OUT}	$B = 0\text{ G}$, Note 1	2.5	3.6	5.0	V
Sensitivity	ΔV_{OUT}	$B = 1000\text{ G}$, Notes 1, 2	0.35	0.7	—	mV/G
Frequency Response	BW	$f_H - f_L$ at -3 dB	—	25	—	kHz
Broadband Output Noise	e_n	$f = 10\text{ Hz to }10\text{ kHz}$	—	0.1	—	mV
Output Resistance	R_{OUT}		—	100	—	Ω

NOTE 1. All output voltage measurements are made with a voltmeter having an input impedance of 10 k Ω or greater.

NOTE 2. Magnetic flux density is measured at the most sensitive area of the device, which is 0.017" (0.43 mm) below the branded side of the "U" package; 0.020" (0.51 mm) below the branded side of the "UA" package.

NORMALIZED SENSITIVITY AS A FUNCTION OF V_{CC}

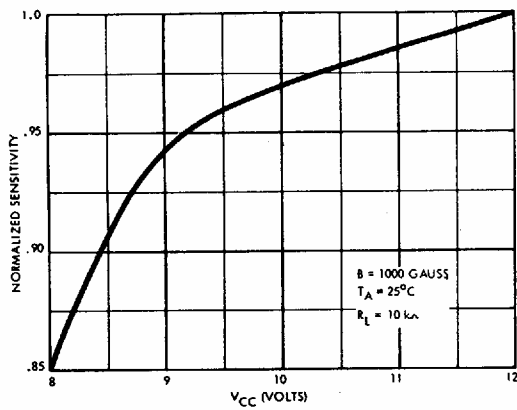

Dwg. No. A-10,522

NORMALIZED SENSITIVITY AS A FUNCTION OF TEMPERATURE

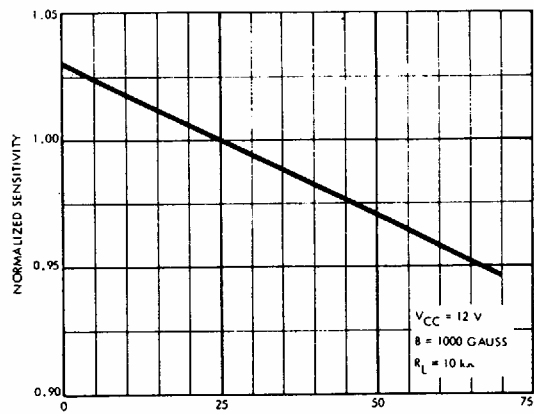

Dwg. No. A-10,521

OUTPUT VOLTAGE AS A FUNCTION OF MAGNETIC FLUX DENSITY

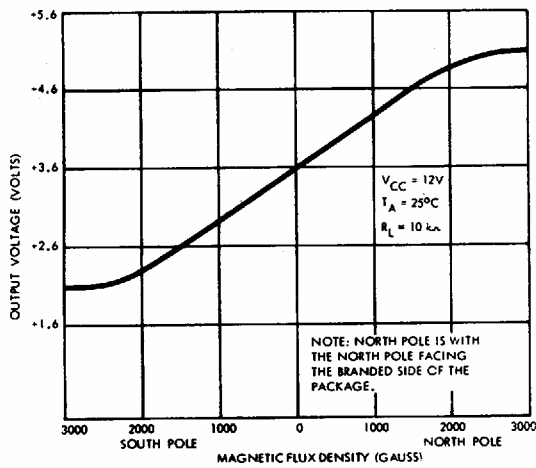

Dwg. No. A-10,523

OUTPUT VOLTAGE AS A FUNCTION OF AIR GAP

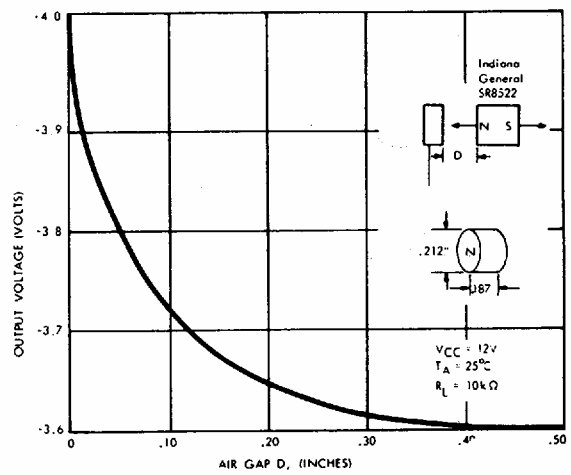

Dwg. No. A-10,519

**NOISE SPECTRAL DENSITY
AS A FUNCTION OF FREQUENCY**

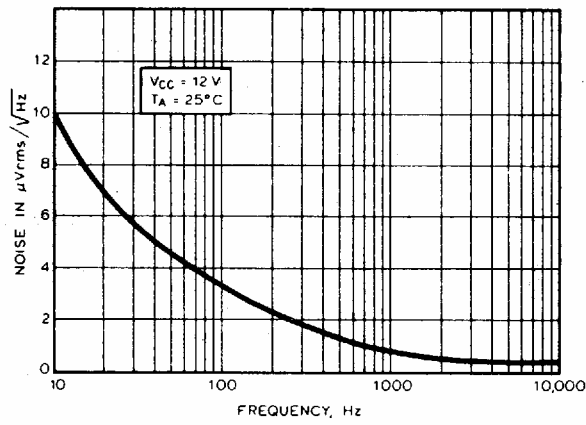

Dwg. No. A-10,520A

TYPICAL APPLICATIONS

SENSITIVE PROXIMITY DETECTOR

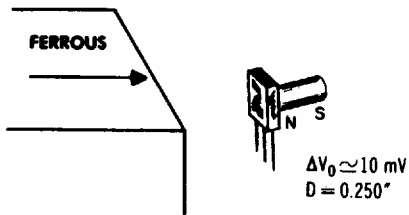

FERROUS METAL SENSOR

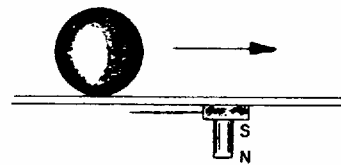

LOBE OR COG SENSOR

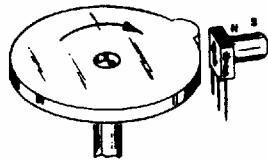

NOTCH OR HOLE SENSOR

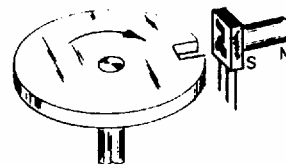

For reference only - an Alnico VIII permanent magnet, 0.212" (5.38 mm) in diameter and 0.187" (4.75 mm) long is approximately 800 gauss at the surface. A samarium cobalt permanent magnet, 0.100" (2.54 mm) square and 0.040" (1.02 mm) thick is approximately 1200 gauss at its surface.