

24mW / 40mW VCSEL SMA Receptacle / Chip

- ◆ Vertical Cavity Surface-Emitting Laser
- ◆ 24mW / 40mW peak power
- ◆ >1 Gbps speed
- ◆ e.g. for storage, free space, sensing
- ◆ other wavelengths available, e.g. for WDM

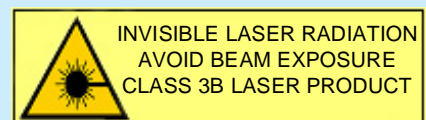
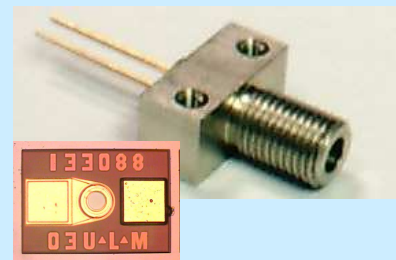

ELECTRO-OPTICAL CHARACTERISTICS Receptacle (Chip)

PARAMETER	SYMBOL	UNITS	MIN	TYP	MAX	TEST CONDITIONS
Emission wavelength	λ_R	nm	835	850	860	T=20°C
Fiber-coupled mean power (power)	mW		24(40)			Fiber 125 μ m, 0.37NA, T=20°C
Threshold current	I_{TH}	mA			20	T=20°C
Variation of I_{TH} over Temp.	$\Delta I_{TH}(T)$	mA		2.0		T=0 .. 70°C
Threshold voltage	U_{TH}	V	1.5	1.8	2.0	
Laser current	I_{OP}	mA		65		$P_{opt}=24mW^*$
Laser voltage	U_{OP}	V	2.0	2.2	2.4	$P_{opt}=24mW^*$
Wallplug efficiency	η_{WP}	%	5	10	20	$P_{opt}=24mW^*$
Slope Efficiency	η_s	W/A	0.3	0.4	0.6	T= 20°C
Variation of η_s over Temp.	$\Delta \eta_s(T)$	W/A		0.2		T= 0 .. 70°C
Differential series resistance	R_s	Ω		9		$P_{opt}=24mW^*$
3dB modulation bandwidth	v_{3dB}	GHz	1			$P_{opt}=24mW^*$
Rise and fall time	t_R/t_F	ns			1	20%..80%; $P_{off/on}=0.5/24mW^*$
Relative intensity noise	RIN	dB/Hz		-130	-120	$P_{opt} = 24mW^* @ 1GHz$
Wavelength tuning over temperature		nm/K		0.07		
Thermal resistance	$R_{thermal}$	K/mW			1	
Spectral bandwidth	$\Delta\lambda$	nm			1	rms
far field angle chip		deg		30		40mW chip output power
far field angle TO56 package		deg		25		40mW TO56 output power

* in optical Fiber 125 μ m, NA 0,37

ABSOLUTE MAXIMUM RATINGS

Storage temperature	-55 ... 125°C
Operating temperature	-30 ... 85°C
Electrical power dissipation	250 mW
Continuous forward current	80 mA
Reverse voltage	8V
Soldering temperature	330°C

NOTICE: Stresses greater than those listed under „Absolute Maximum Ratings“ may cause permanent damage to the device. These are stress ratings only and functional operation of the device at these or any other condition beyond those indicated for extended periods of time may effect device reliability.



ATTENTION: Electrostatic Sensitive Devices
Observe Precautions for Handling

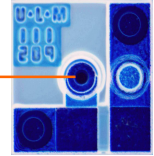

LIV
(optical fiber
125µm, NA 0.37)

Other fiber core
diameters available
upon request

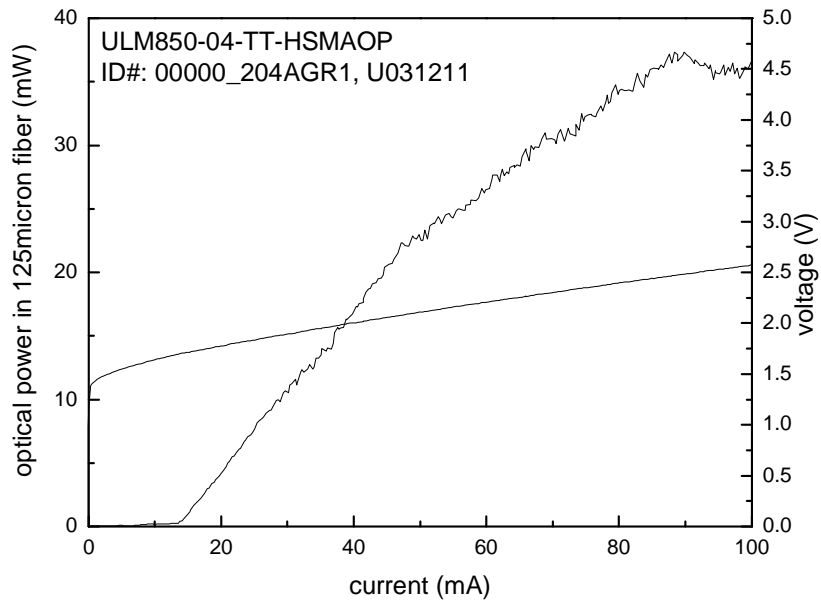

Description	24mW VCSEL SMA Receptacle	40mW VCSEL TO56	40mW VCSEL Chip
Cap	-	Ball lense	-
Common	anode	anode	-
Type			
with Monitor (PD)	on request	on request	-
without Monitor	ULM850-04-TT-HSMAOP	ULM850-04-TT-H56BOP	ULM850-04-TT-H0101U

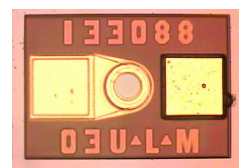
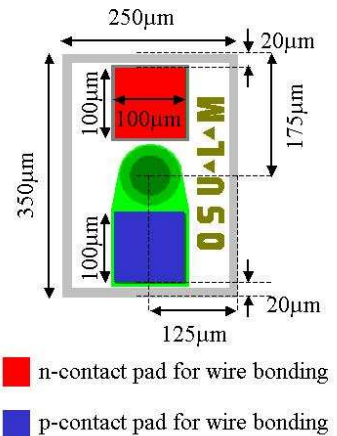
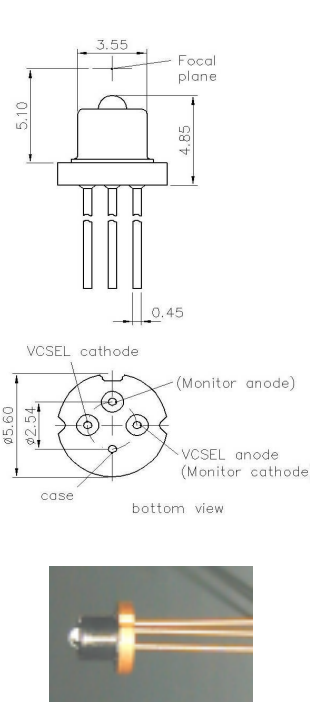
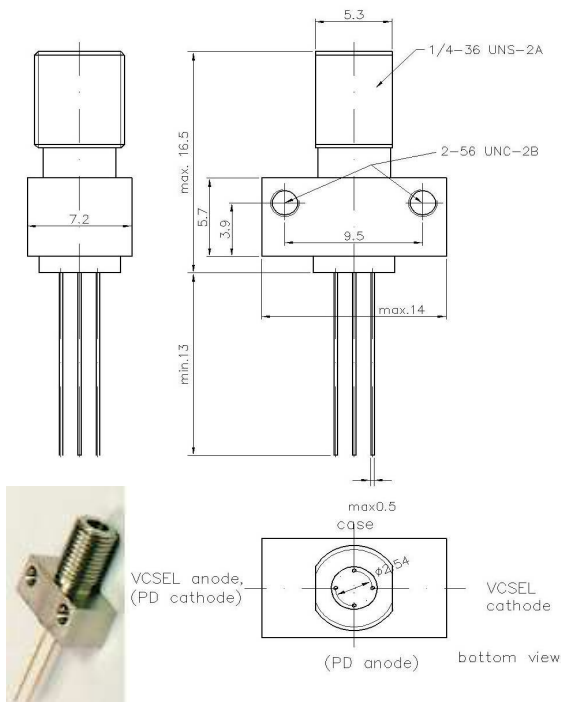

Contact **U-L-M photonics GmbH / D** | **SESNA-Corp. / Japan** | **HIKARI-Inc. / Japan** | **Lamtron Co., Ltd. / Korea**
 Fon (Fax) **+49(0)731 550194-011 (-026)** ▲ **+81(0)3 5976 13-71 (-74)** ▲ **+81(0)3 38331-17 (-18)** ▲ **+82 31 719 4337 (4338)**
 Email **sales@ulm-photonics.de** | **kumazawa@sesna.net** | **ohta@hikari-trading.com** | **william66@hanafos.com**