



ULN-2429A FLUID DETECTOR

FEATURES

- High Output Current
- A-C or D-C Output
- Single-Wire Probe
- Low External Parts Count
- Internal Voltage Regulator
- Reverse Voltage Protection
- 14-Pin Dual In-Line Plastic Package

PRIMARILY DESIGNED for use as an automotive low coolant detector, the ULN-2429A monolithic bipolar integrated circuit is ideal for detecting the presence or absence of many different types of liquids in automotive, home, or industrial applications. Especially useful in harsh environments, reverse voltage protection, internal voltage regulation, temperature compensation, and high-frequency noise immunity are all incorporated in the design.

A simple probe, immersed in the fluid being monitored, is driven with an a-c signal to prevent plating problems. The presence, absence, or condition of the fluid is determined by comparing the loaded probe resistance with an internal (pin 8) or external (pin 6) resistance. Typical conductive fluids which can be sensed are tap water, sea water, weak acids and bases, wet soil, wine, beer, and coffee. Non-conductive fluids include most petroleum products, distilled water, dry soil, and vodka. The probe can be replaced with any variable-resistance element such as a photodiode or photoconductive cell, rotary or linear position sensor, or thermistor for detecting solids, non-conducting liquids, gases, etc.

The high-current output is typically a square wave signal for use with an LED, incandescent lamp, or loudspeaker. A capacitor can be connected (pin 12) to provide a d-c output for use with inductive loads such as relays and solenoids.

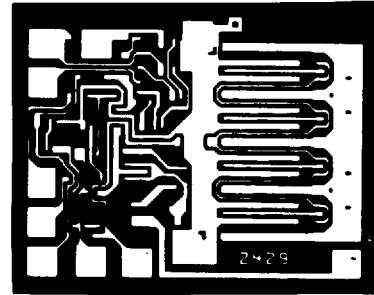

The ULN-2429A is rated for operation with a load voltage of up to 30 volts. Selected devices, for operation up to 50 V are available as the ULN-2429A-1. In all other respects, the ULN-2429A and the ULN-2429A-1 fluid detectors are identical.

These devices are furnished in an improved 14-lead dual in-line plastic package with a copper alloy lead frame for superior thermal characteristics. However, in order to realize the maximum current-handling capability of these devices, both of the output pins (1 and 14) and both ground pins (3 and 4) should be used.

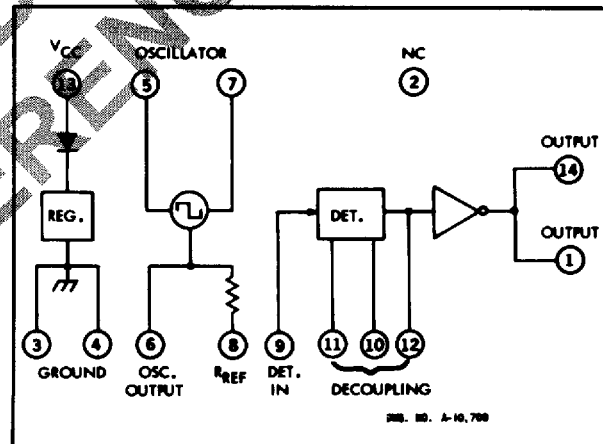

FUNCTIONAL BLOCK DIAGRAM

ABSOLUTE MAXIMUM RATINGS

Supply Voltage, V_{CC} (continuous) +16 V, -50 V
 (1 hr. at +25°C) +24 V
 (10 μ s) +50 V
 Output Voltage, V_{OUT} (ULN-2429A) +30 V
 (ULN-2429A-1) +50 V
 Output Current, I_{OUT} (continuous) 700 mA
 (1 hr. at +25°C) 1.0 A
 Package Power Dissipation, P_D 1.33 W*
 Operating Temperature Range, T_A -40°C to +85°C
 Storage Temperature Range, T_S -65°C to +150°C
 *Derate at the rate of 16.67 mW/°C above $T_A = +70^\circ\text{C}$.

**ELECTRICAL CHARACTERISTICS at $T_A = +25^\circ\text{C}$, $V_{CC} = V_{OUT} = +12\text{ V}$
 (unless otherwise specified)**

| Characteristic | Symbol | Test Pin | Test Conditions | Limits | | | |
|---------------------------|-----------|----------|---|--------|------|------|---------------|
| | | | | Min. | Typ. | Max. | Units |
| Supply Voltage Range | V_{CC} | 13 | — | 10 | — | 16 | V |
| Supply Current | I_{CC} | 13 | $V_{CC} = +16\text{V}$ | — | — | 10 | mA |
| Oscillator Output Voltage | V_{osc} | 6 | $R_L = 18\text{ k}\Omega$ | — | 3.0 | — | V_{PP} |
| Output ON Voltage | V_{OUT} | 1,14 | $R_L \geq 30\text{ k}\Omega, I_{OUT} = 500\text{ mA}$ | — | 0.9 | 1.5 | V |
| Output OFF Current | I_{OUT} | 1,14 | $R_L \leq 10\text{ k}\Omega, V_{OUT} = V_{OUT(max)}$ | — | — | 100 | μA |
| Oscillator Frequency | f_{osc} | 6 | $R_L = 18\text{ k}\Omega$ | — | 2.4 | — | kHz |

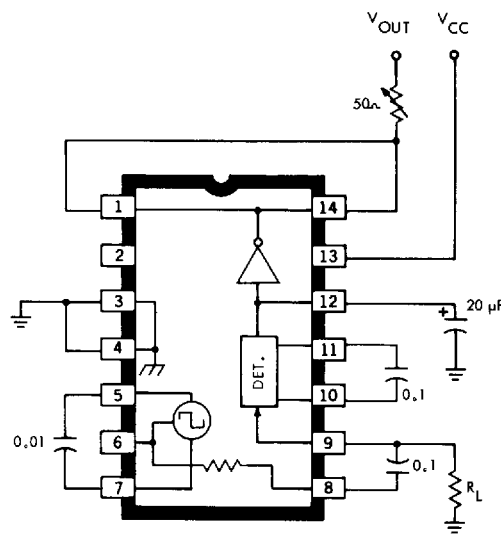

DWG. NO. A-10.707

TEST CIRCUIT

ULN-2429A FLUID DETECTOR

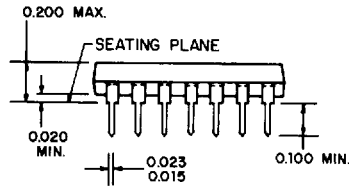
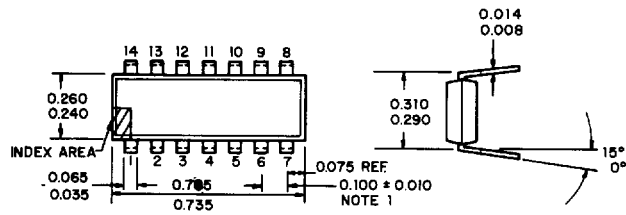

NOTES:

1. LEAD SPACING TOLERANCE IS NON-CUMULATIVE.
2. EXACT BODY AND LEAD CONFIGURATION AT VENDOR'S OPTION WITHIN LIMITS SHOWN.
3. LEADS MISSING FROM THEIR DESIGNATED POSITIONS SHALL ALSO BE COUNTED WHEN NUMBERING LEADS.
4. TERMINAL LEAD STANDOFFS MAY BE OMITTED AND REPLACED BY BODY STANDOFFS.
5. LEAD GAUGE PLANE IS 0.030 MAX. BELOW SEATING PLANE.

DWG. NO. A-54966 IN

DIMENSIONS IN INCHES

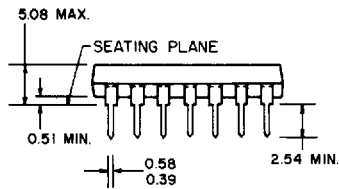
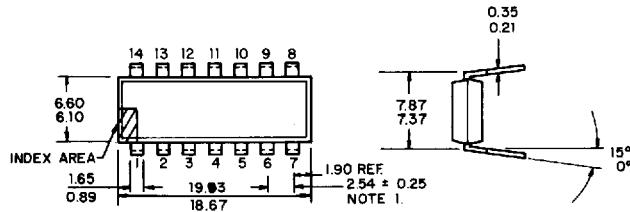

NOTES:

1. LEAD SPACING TOLERANCE IS NON-CUMULATIVE.
2. EXACT BODY AND LEAD CONFIGURATION AT VENDOR'S OPTION WITHIN LIMITS SHOWN.
3. LEADS MISSING FROM THEIR DESIGNATED POSITIONS SHALL ALSO BE COUNTED WHEN NUMBERING LEADS.
4. TERMINAL LEAD STANDOFFS MAY BE OMITTED AND REPLACED BY BODY STANDOFFS.
5. LEAD GAUGE PLANE IS 0.76 MAX. BELOW SEATING PLANE.

DWG. NO. A-54966 MM

DIMENSIONS IN MILLIMETRES

In the construction of the components described, the full intent of the specification will be met. The Sprague Electric Company, however, reserves the right to make, from time to time, such departures from the detail specifications as may be required to permit improvements in the design of its products. Components made under military approvals will be in accordance with the approval requirements.

The information included herein is believed to be accurate and reliable. However, the Sprague Electric Company assumes no responsibility for its use; nor for any infringements of patents or other rights of third parties which may result from its use.