

ULN2803AP, ULN2803AFW, ULN2804AP, ULN2804AFW

8CH DARLINGTON SINK DRIVER

The ULN2803AP/AFW Series are high-voltage, high-current darlington drivers comprised of eight NPN darlington pairs.

All units feature integral clamp diodes for switching inductive loads

Applications include relay, hammer, lamp and display (LED) drivers.

FEATURES

- Outputs current (Single output)
500mA (Max.) (ULN2803AP/AFW series)
- High sustaining voltage output
50V (Min.) (ULN2803AP/AFW series)
- Output clamp diodes
- Inputs compatible with various types of logic.
- Package type-AP :DIP-18pin
- Package type-AFW :SOL-18pin

| TYPE | INPUT BASE RESISTOR | DESIGNATION |
|---------------|---------------------|------------------|
| ULN2803AP/AFW | 2.7KΩ | TTL,5V CMOS |
| ULN2804AP/AFW | 10.5KΩ | 6~15V PMOS, CMOS |

ULN2803AP

ULN2804AP

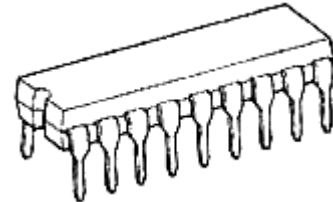

DIP 18-P-300-2.54F

ULN2803AFW

ULN2804AFW

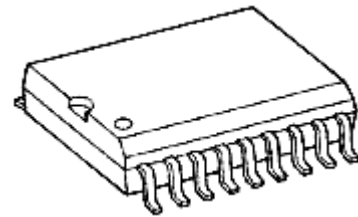

SOL 18-P-300-1.27

Weight

DIP18-P-300-2.54F : 1.478g (Typ.)

SOL18-P-300-1.27 : 0.48g (Typ.)

PIN CONNECTION (TOP VIEW)

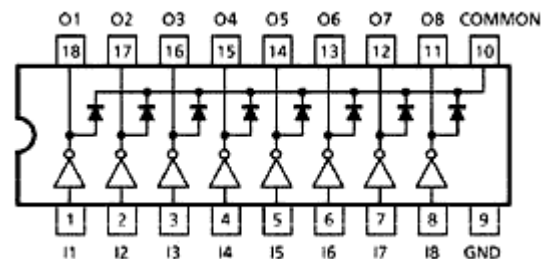

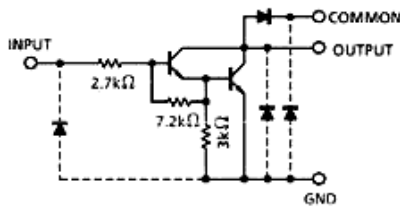
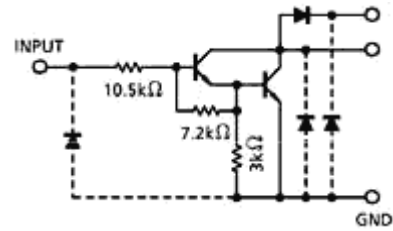
SCHEMATICS (EACH DRIVER)
ULN2803AP/AFW

ULN2804AP/AFW

(Note) The input and output parasitic diodes cannot be used as clamp diodes.

MAXIMUM RATING (Ta=25)

| CHARACTERISTIC | SYMBOL | RATING | UNIT |
|-----------------------------|---------------|---------|------------------|
| Output Sustaining Voltage | $V_{CE(SUS)}$ | -0.5~50 | V |
| Output Current | I_{OUT} | 500 | mA/ch |
| Input Voltage | V_{IN} | -0.5~30 | V |
| Clamp Diode Reverse Voltage | V_R | 50 | V |
| Clamp Diode Forward Current | I_F | 500 | mA |
| Power Dissipation | AP | P_D | W |
| | AFW | | |
| | | | 0.92/1.31 (Note) |
| Operating Temperature | T_{opr} | -40~85 | |
| Storage Temperature | T_{stg} | -50~150 | |

(Note) On Glass Epoxy PCB (75 x 114 x 1.6mm Cu 20%)

RECOMMENDED OPERATING CONDITIONS (Ta = -40~85)

| CHARACTERISTIC | SYMBOL | TEST CONDITION | MIN. | TYP. | MAX. | UNIT | |
|-----------------------------|---------------|----------------|---|------|------|-------|-----|
| Output Sustaining Voltage | $V_{CE(SUS)}$ | | 0 | - | 50 | V | |
| | | | $T_{pw} = 25ms, Duty=10\%$ | 0 | - | | 347 |
| | | AP | 8 Circuits $T_{pw}=25ms, Duty =50\%$ | 0 | - | | 123 |
| Output Current | I_{OUT} | | | | | mA/ch | |
| | | AFW | 8 Circuits $T_{pw}=25ms, Duty =10\%$ | 0 | - | | 268 |
| | | | 8 Circuits $T_{pw}=25ms, Duty =50\%$ | 0 | - | | 90 |
| Input Voltage | V_{IN} | | 0 | - | 30 | V | |
| Input Voltage | ULN2803AP/AFW | $V_{IN(ON)}$ | 3.5 | - | 30 | V | |
| | ULN2804AP/AFW | | 8 | - | 30 | | |
| Clamp Diode Reverse Voltage | V_R | | - | - | 50 | v | |
| Clamp Diode Forward Current | I_F | | - | - | 400 | mA | |
| Power Dissipation | AP | P_D | $T_a = 85$ | - | - | 0.76 | w |
| | AFW | | $T_a=85$ (Note) | - | - | 0.48 | |

(Note) On Glass Epoxy PCB (75 x 114 x 1.6 mm Cu 20%)

ELECTRICAL CHARACTERISTICS (Ta=25)

| CHARACTERISTIC | | SYMBOL | TEST CIRCUIT | TEST CONDITION | MIN. | TYP. | MAX. | UNIT |
|--------------------------------------|--|----------------------|--------------|---|------|------|------|------|
| Output Leakage Current | ULN2804AP/AFW | I _{CEX} | 1 | V _{CE} =50V, Ta=25 | - | - | 50 | μA |
| | | | | V _{CE} =50V, Ta=85 | - | - | 100 | |
| | | | | V _{CE} =50V, V _{IN} =1V | - | - | 500 | |
| Collector-Emitter Saturation Voltage | | V _{CE(sat)} | 2 | I _{OUT} =350mA, I _{IN} =500μA | - | 1.3 | 1.6 | V |
| | | | | I _{OUT} =200mA, I _{IN} =350μA | - | 1.1 | 1.3 | |
| | | | | I _{OUT} =100mA, I _{IN} =250μA | - | 0.9 | 1.1 | |
| Input Current | ULN2803AP/AFW | I _{IN(ON)} | 2 | V _{IN} =3.85V | - | 0.93 | 1.35 | mA |
| | ULN2803AP/AFW | | | V _{IN} =5V | - | 0.35 | 0.5 | |
| | ULN2803AP/AFW | | | V _{IN} =12V | - | 1.0 | 1.45 | |
| | | I _{IN(OFF)} | 4 | I _{OUT} =500μA, Ta=85 | 50 | 65 | - | μA |
| Input Voltage (Output On) | ULN2803AP/AFW | V _{IN(ON)} | 5 | V _{CE} =2V, I _{OUT} =200mA | - | - | 2.4 | V |
| | | | | V _{CE} =2V, I _{OUT} =250mA | - | - | 2.7 | |
| | | | | V _{CE} =2V, I _{OUT} =300mA | - | - | 3.0 | |
| | ULN2804AP/AFW | | | V _{CE} =2V, I _{OUT} =125mA | - | - | 5.0 | |
| | V _{CE} =2V, I _{OUT} =200mA | | | - | - | 6.0 | | |
| | V _{CE} =2V, I _{OUT} =275mA | | | - | - | 7.0 | | |
| | V _{CE} =2V, I _{OUT} =350mA | | | - | - | 8.0 | | |
| DC Current Transfer Ratio | | h _{FE} | 2 | V _{CE} =2V, I _{OUT} =350mA | 1000 | - | - | |
| Clamp Diode Reverse Current | | I _R | 6 | Ta=25 (Note) | - | - | 50 | μA |
| | | | | Ta=85 (Note) | - | - | 100 | |
| Clamp Diode Forward Voltage | | V _F | 7 | I _F =350mA | - | - | 2.0 | V |
| Input Capacitance | | C _{IN} | - | | - | 15 | - | pF |
| Turn-On Delay | | t _{ON} | 8 | R _L =125Ω, V _{OUT} =50V | - | 0.1 | - | μS |
| Turn-Off Delay | | t _{OFF} | | R _L =125Ω, V _{OUT} =50V | - | 0.2 | - | |

 (Note) V_R =V_R MAX.

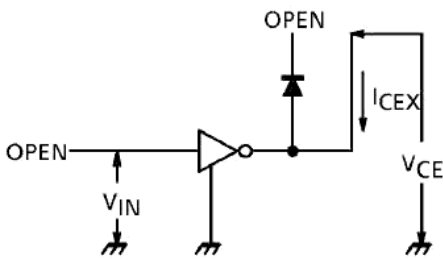
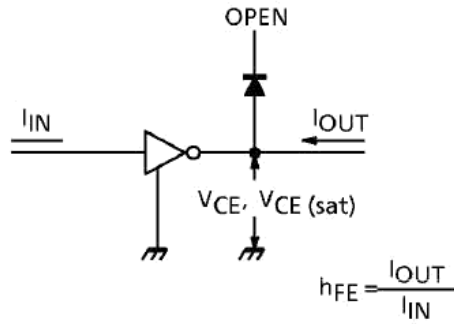
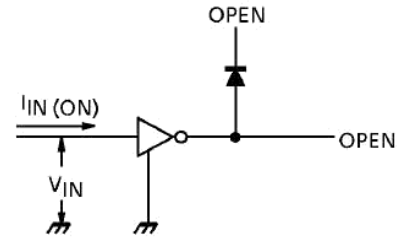
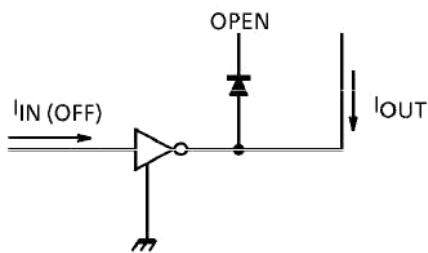
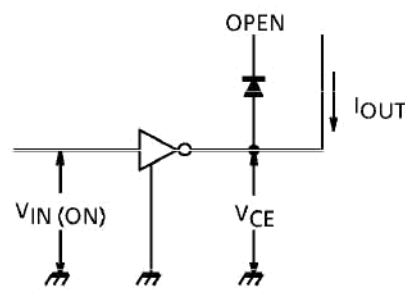
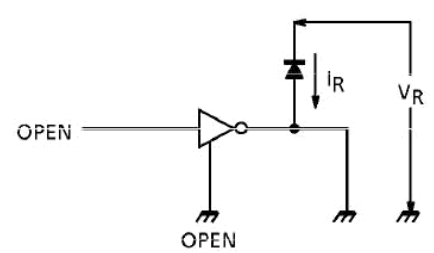
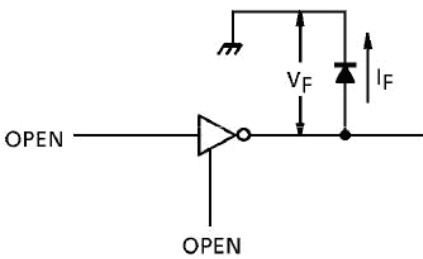
TEST CIRCUIT
1. I_{CEX}

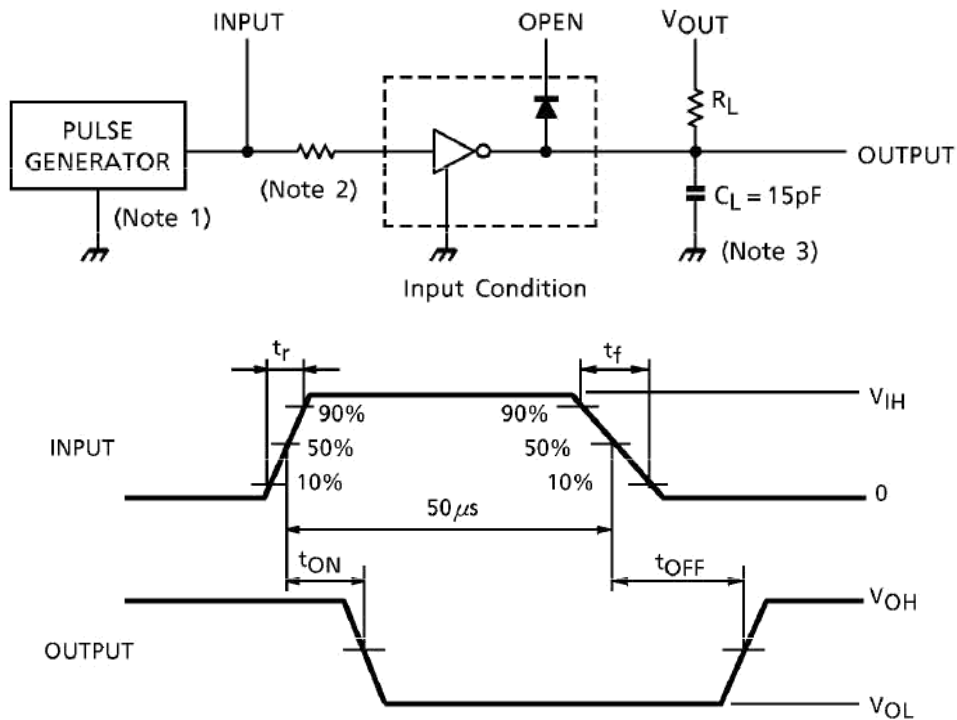
2. $V_{CE(sat)}$, h_{FE}

3. $I_{IN(ON)}$

4. $I_{IN(OFF)}$

5. $V_{IN(ON)}$

6. I_R

7. V_F

8. t_{ON}, t_{OFF}

(Note 1) Pulse Width 50µs, Duty Cycle 10%
Output Impedance 50Ω, tr ≤ 5ns, tf ≤ 10ns

(Note 2) See below.

INPUT CONDITION

| TYPE NUMBER | R1 | V _{IH} |
|---------------|----|-----------------|
| ULN2803AP/AFW | 0Ω | 3V |
| ULN2804AP/AFW | 0Ω | 8V |

(Note 3) C_L includes probe and jig capacitance.

PRECAUTIONS for USING

Utmost care is necessary in the design of the output line, COMMON and GND line since IC may be destroyed due to short-circuit between outputs, air contamination fault, or fault by improper grounding.

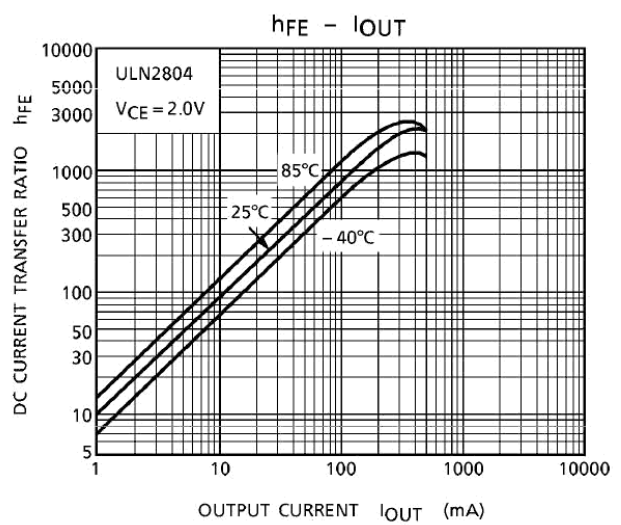
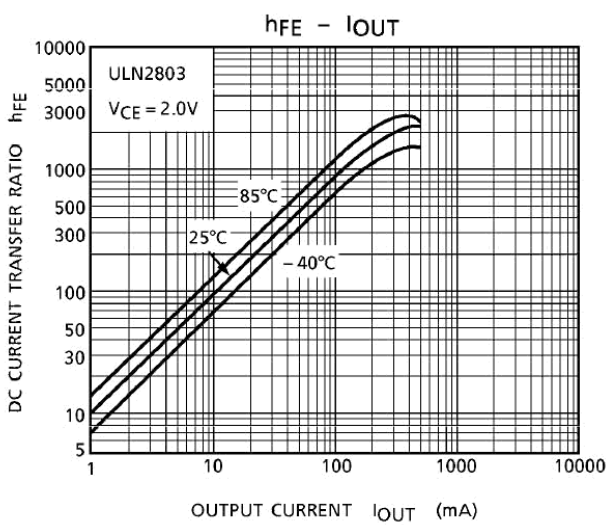
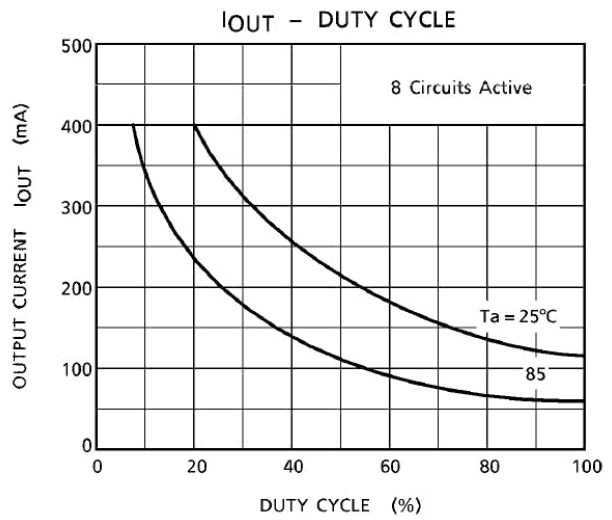
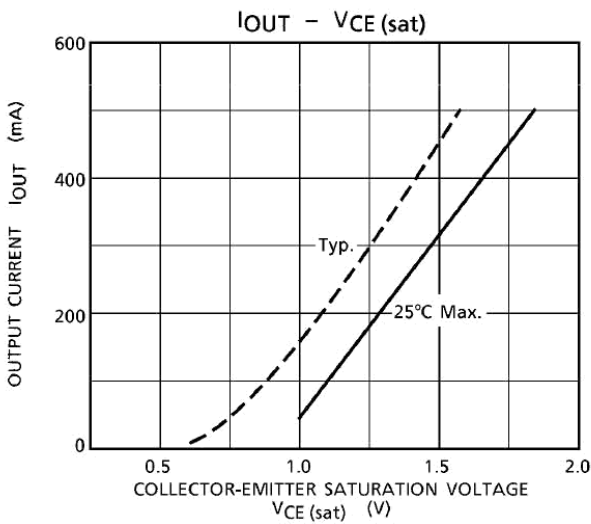
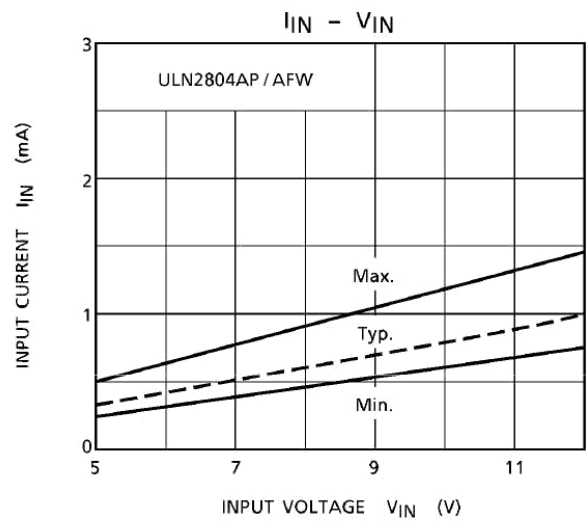
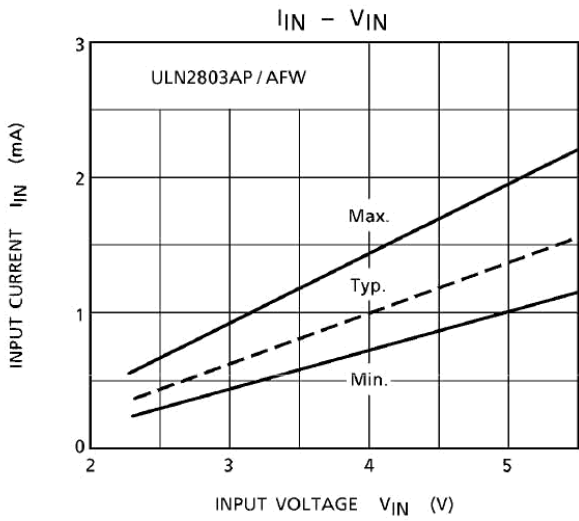

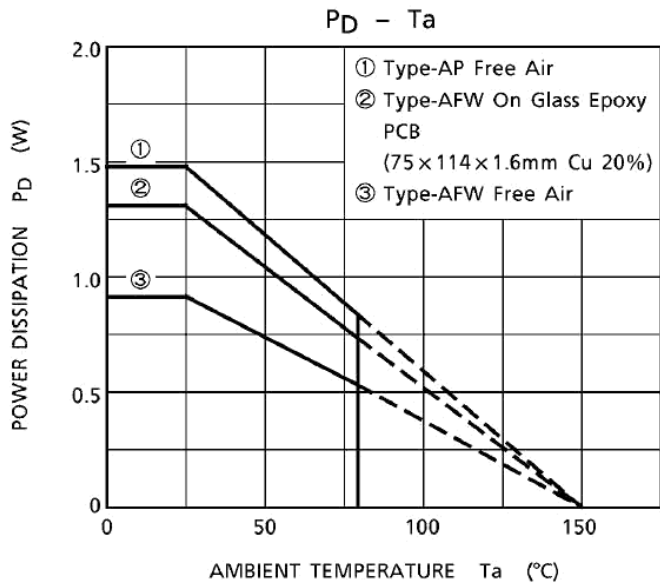

OUTLINE DRAWING

DIP18-P-300-2.54F

Unit:mm

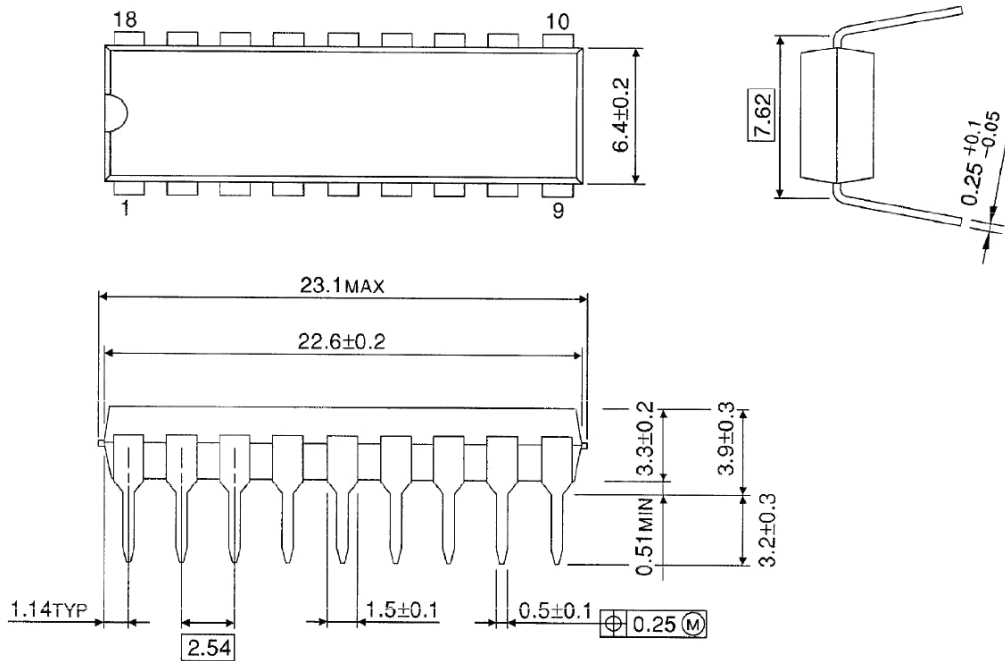

Weight:1.478g (Typ.)

OUTLINE DRAWING

SOL18-P-300-1.27

Unit:mm

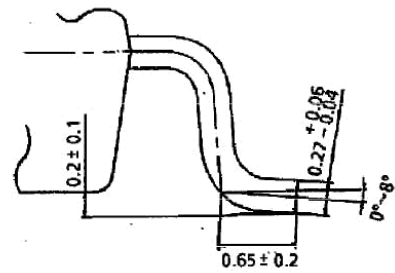
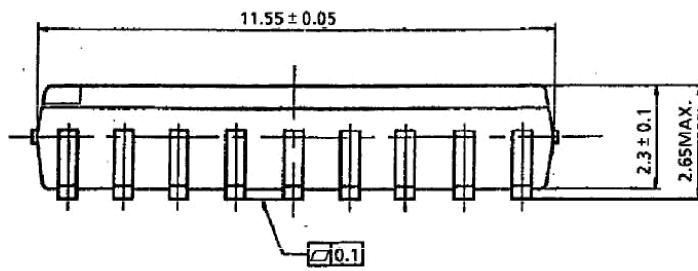
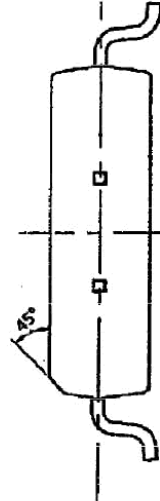
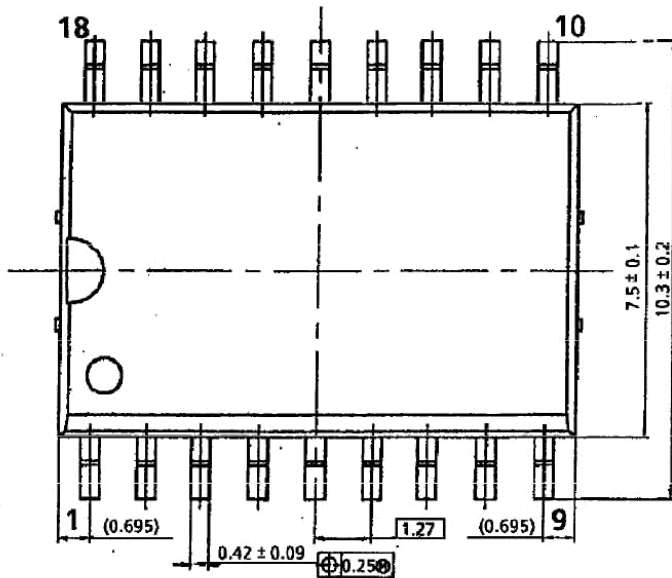

Weight : 0.48g (Typ.)